

AV RECEIVER/AV AMPLIFIER RX-V465/HTR-6240/ AX-V465 SERVICE MANUAL

RX-V465/HTR-6240/
AX-V465

IMPORTANT NOTICE

This manual has been provided for the use of authorized YAMAHA Retailers and their service personnel. It has been assumed that basic service procedures inherent to the industry, and more specifically YAMAHA Products, are already known and understood by the users, and have therefore not been restated.

WARNING: Failure to follow appropriate service and safety procedures when servicing this product may result in personal injury, destruction of expensive components, and failure of the product to perform as specified. For these reasons, we advise all YAMAHA product owners that any service required should be performed by an authorized YAMAHA Retailer or the appointed service representative.

IMPORTANT: The presentation or sale of this manual to any individual or firm does not constitute authorization, certification or recognition of any applicable technical capabilities, or establish a principle-agent relationship of any form.

The data provided is believed to be accurate and applicable to the unit(s) indicated on the cover. The research, engineering, and service departments of YAMAHA are continually striving to improve YAMAHA products. Modifications are, therefore, inevitable and specifications are subject to change without notice or obligation to retrofit. Should any discrepancy appear to exist, please contact the distributor's Service Division.

WARNING: Static discharges can destroy expensive components. Discharge any static electricity your body may have accumulated by grounding yourself to the ground buss in the unit (heavy gauge black wires connect to this buss).

IMPORTANT: Turn the unit OFF during disassembly and part replacement. Recheck all work before you apply power to the unit.

■ CONTENTS

TO SERVICE PERSONNEL	2	DISPLAY DATA	66-67
FRONT PANELS	3-4	IC DATA	68-85
REAR PANELS	5-9	PIN CONNECTION DIAGRAMS	86-87
REMOTE CONTROL PANEL	10	BLOCK DIAGRAMS	88-91
SPECIFICATIONS / 参考仕様	11-17	PRINTED CIRCUIT BOARDS	92-109
INTERNAL VIEW	18	SCHEMATIC DIAGRAMS	111-121
SERVICE PRECAUTIONS / サービス時の注意事項	18	REPLACEMENT PARTS LIST	123-141
DISASSEMBLY PROCEDURES / 分解手順	19-21	REMOTE CONTROL	142-144
UPDATING FIRMWARE / ファームウェアの書き込み	22-33	ADVANCED SETUP / 本機の基本設定/初期化を行う	145-148
SELF-DIAGNOSTIC FUNCTION / ダイアグ (自己診断機能)	34-65		



このサービスマニュアルは、エコマーク認定の再生紙を使用しています。
This Service Manual uses recycled paper.

101134

Copyright © 2009 YAMAHA CORPORATION All rights reserved.
This manual is copyrighted by YAMAHA and may not be copied or
redistributed either in print or electronically without permission.



YAMAHA CORPORATION
P.O.Box 1, Hamamatsu, Japan
animate '09.03

■ TO SERVICE PERSONNEL

1. Critical Components Information

Components having special characteristics are marked Δ and must be replaced with parts having specifications equal to those originally installed.

2. Leakage Current Measurement (For 120V Models Only)

When service has been completed, it is imperative to verify that all exposed conductive surfaces are properly insulated from supply circuits.

- Meter impedance should be equivalent to 1500 ohms shunted by 0.15 μ F.

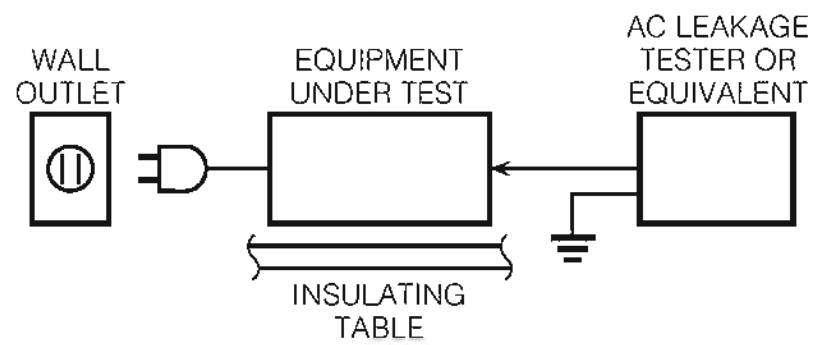

- Leakage current must not exceed 0.5mA.
- Be sure to test for leakage with the AC plug in both polarities.



For U model

“CAUTION”

“F3701: FOR CONTINUED PROTECTION AGAINST RISK OF FIRE, REPLACE ONLY WITH SAME TYPE 6A, 125V FUSE.”

For C model

CAUTION

F3701: REPLACE WITH SAME TYPE 6A, 125V FUSE.

ATTENTION

F3701: UTILISER UN FUSIBLE DE RECHANGE DE MÊME TYPE DE 6A, 125V.

WARNING: CHEMICAL CONTENT NOTICE!

This product contains chemicals known to the State of California to cause cancer, or birth defects or other reproductive harm.

DO NOT PLACE SOLDER, ELECTRICAL/ELECTRONIC OR PLASTIC COMPONENTS IN YOUR MOUTH FOR ANY REASON WHATSOEVER!

Avoid prolonged, unprotected contact between solder and your skin! When soldering, do not inhale solder fumes or expose eyes to solder/flux vapor!

If you come in contact with solder or components located inside the enclosure of this product, wash your hands before handling food.

About lead free solder / 無鉛ハンダについて

All of the P.C.B.s installed in this unit and solder joints are soldered using the lead free solder.

Among some types of lead free solder currently available, it is recommended to use one of the following types for the repair work.

- Sn + Ag + Cu (tin + silver + copper)
- Sn + Cu (tin + copper)
- Sn + Zn + Bi (tin + zinc + bismuth)

Caution:

As the melting point temperature of the lead free solder is about 30°C to 40°C (50°F to 70°F) higher than that of the lead solder, be sure to use a soldering iron suitable to each solder.

本機に搭載されているすべての基板およびハンダ付けによる接合部は無鉛ハンダでハンダ付けされています。

無鉛ハンダにはいくつかの種類がありますが、修理時には下記のような無鉛ハンダの使用を推奨します。

- Sn+Ag+Cu (錫 + 銀 + 銅)
- Sn+Cu (錫 + 銅)
- Sn+Zn+Bi (錫 + 亜鉛 + ビスマス)

注意：

無鉛ハンダの融点温度は通常の鉛入りハンダに比べ 30 ~ 40°C程度高くなっていますので、それぞれのハンダに合ったハンダこてをご使用ください。

FRONT PANELS

Top view

U, C, R, T, K, A, B, G, E, F, L models

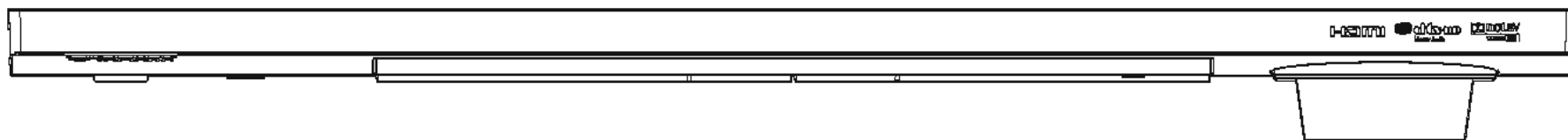

J model

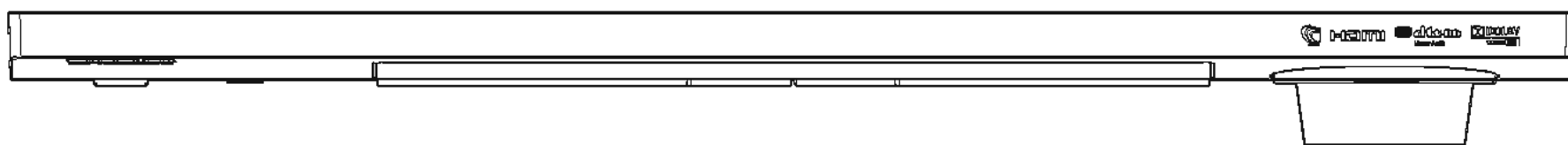

Front view

RX-V465 (U, C, R, K, A, B, G, E, F, L models)

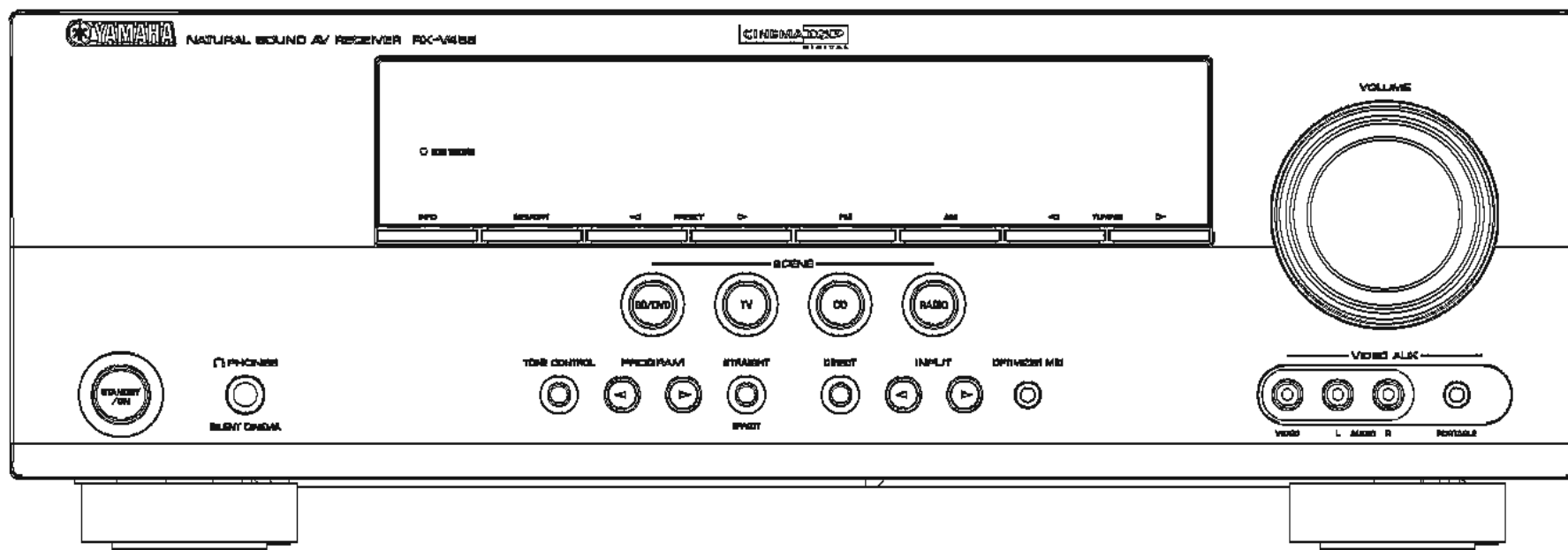

RX-V465 (T model)

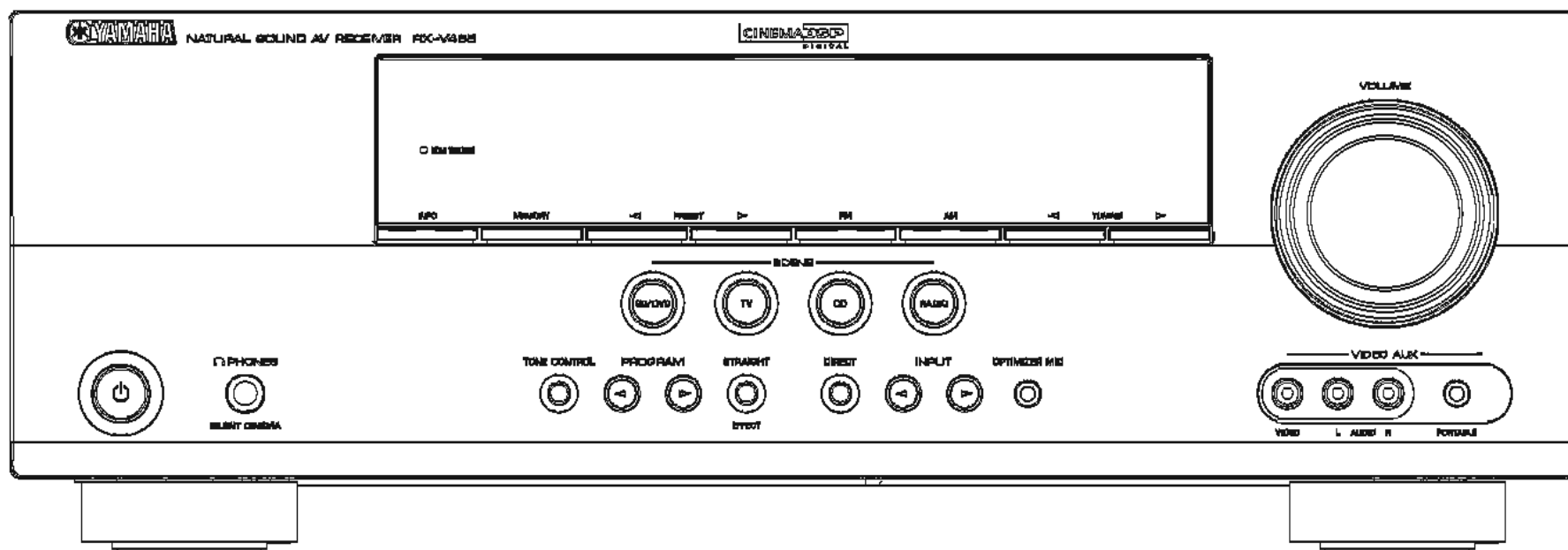

HTR-6240 (U, C, K, E, F models)

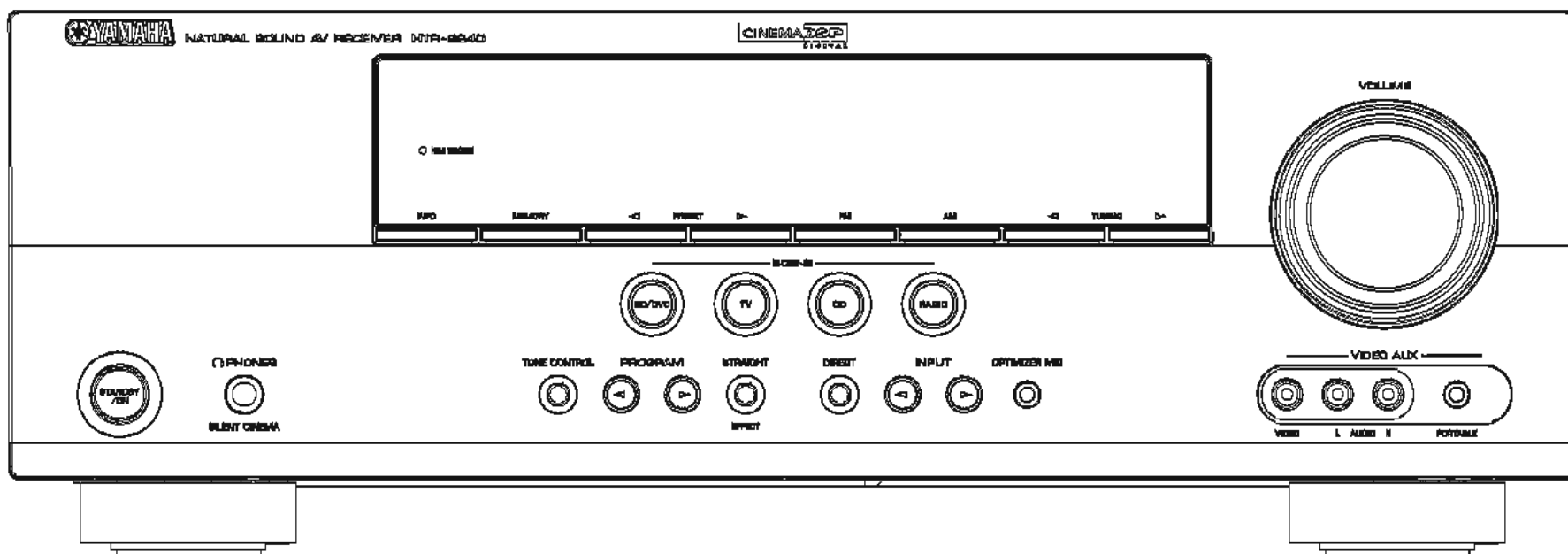

HTR-6240 (T model)

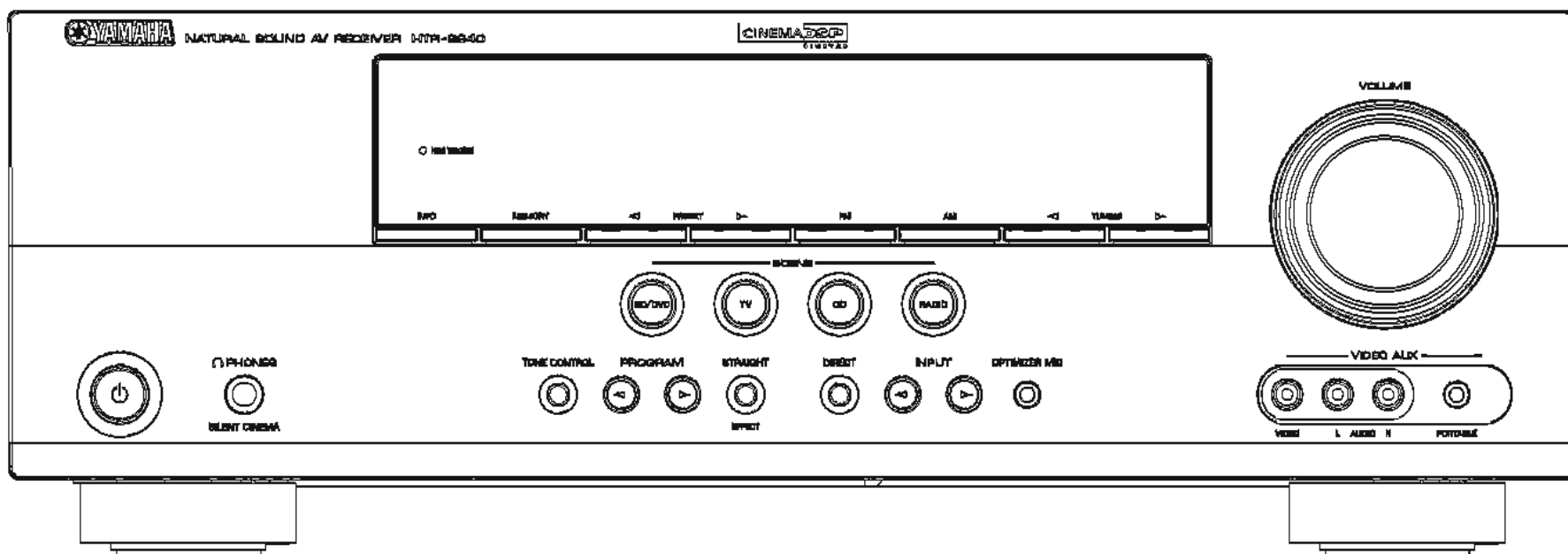

AX-V465 (J model)

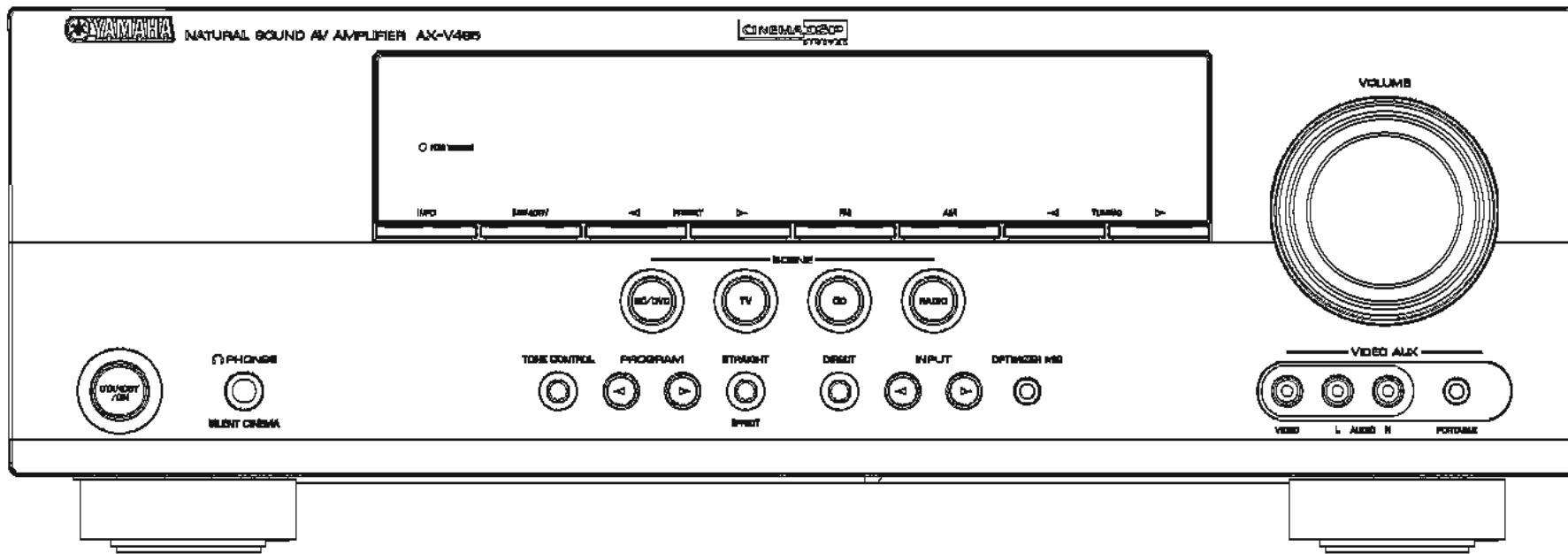

RX-V465/HTR-6240/
AX-V465

RX-V465 (T model)

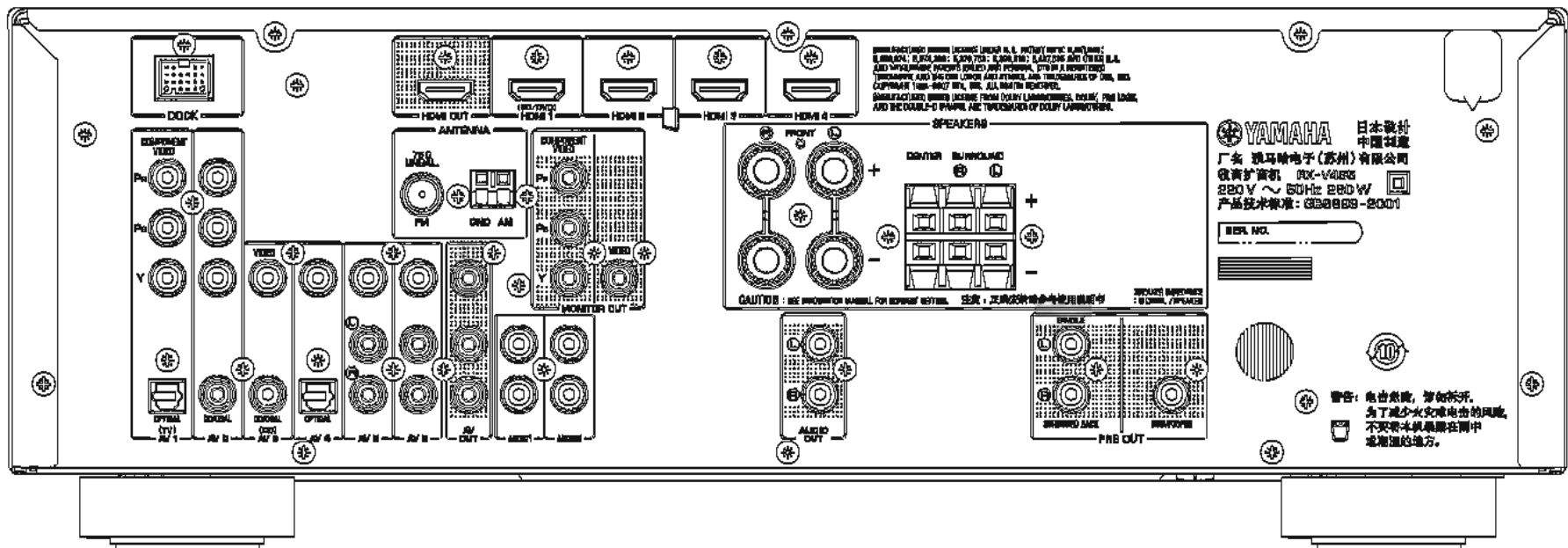

RX-V465 (K model)

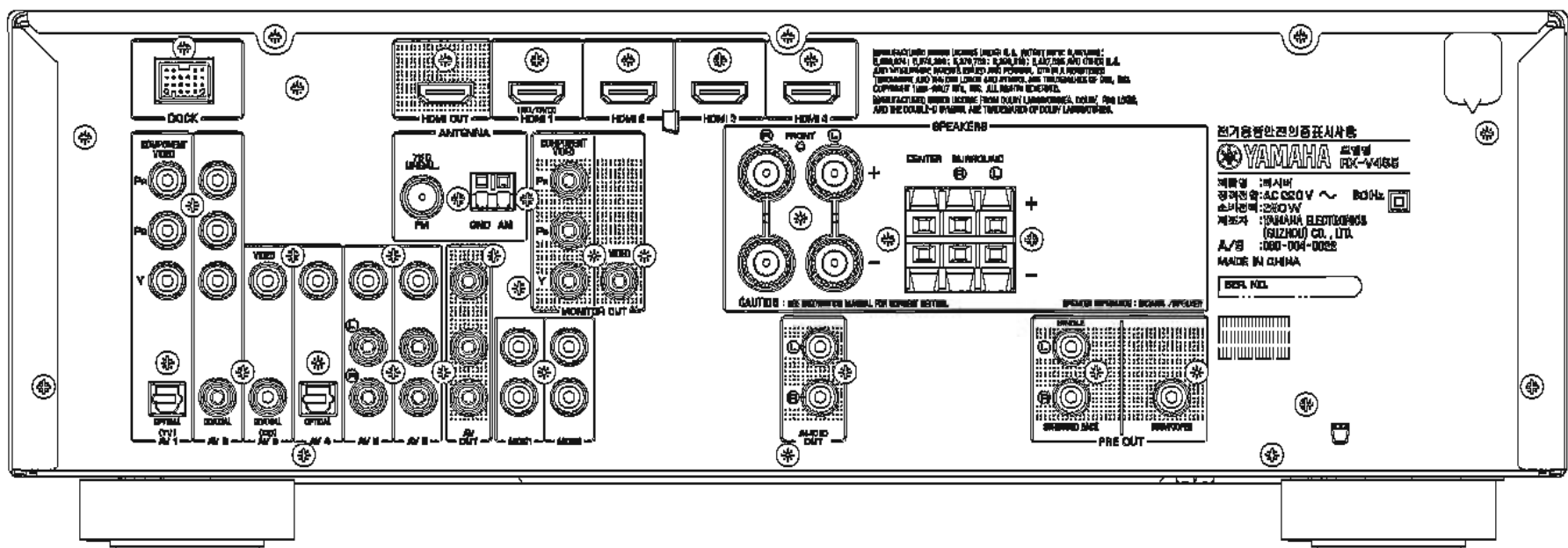

RX-V465 (A model)

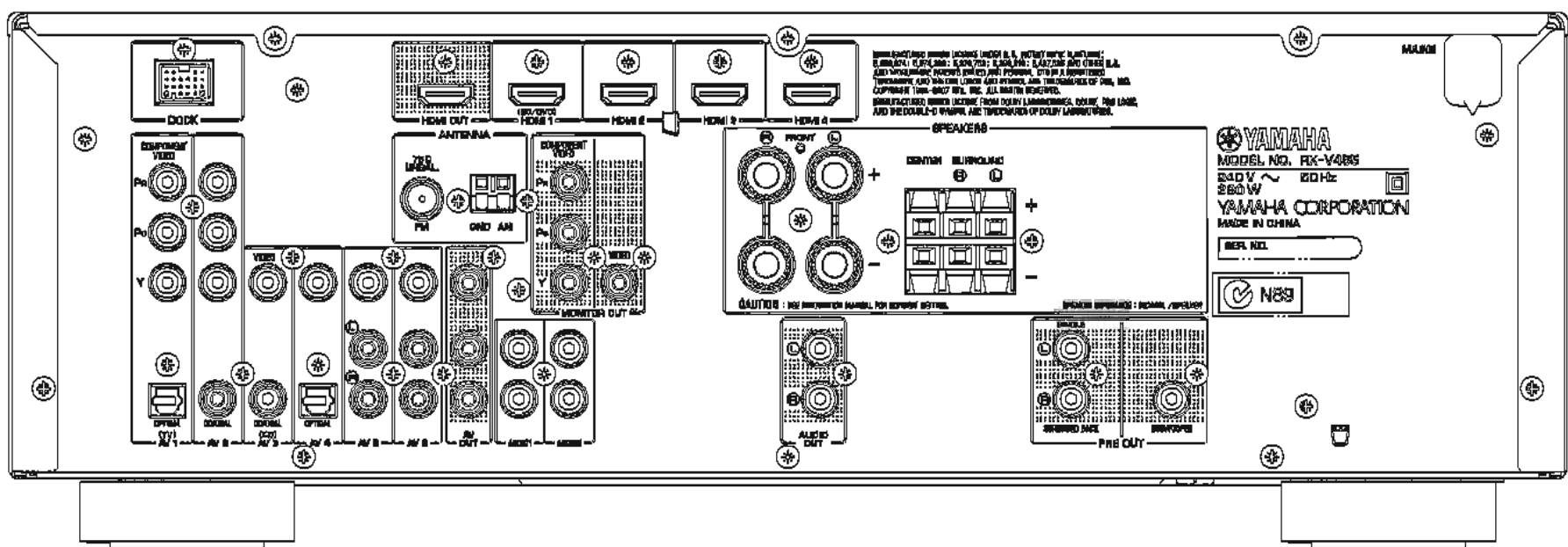

RX-V465/HTR-6240/
 AX-V465

RX-V465 (B, G, E, F models)

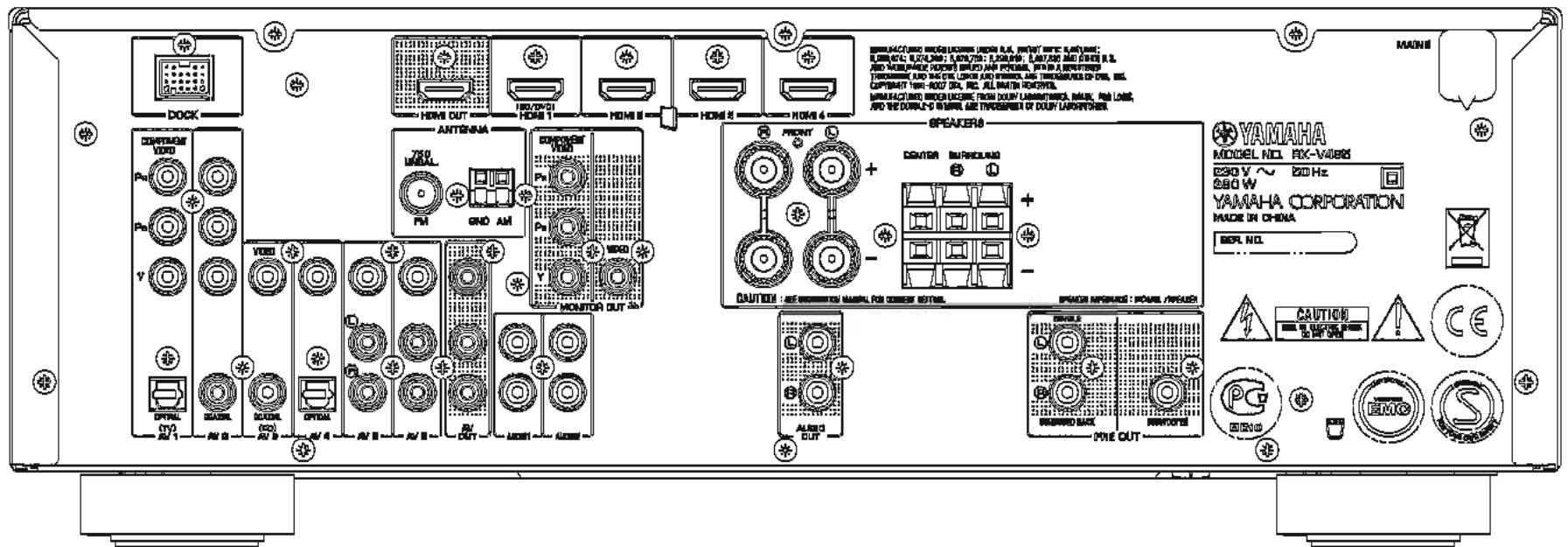

RX-V465 (L model)

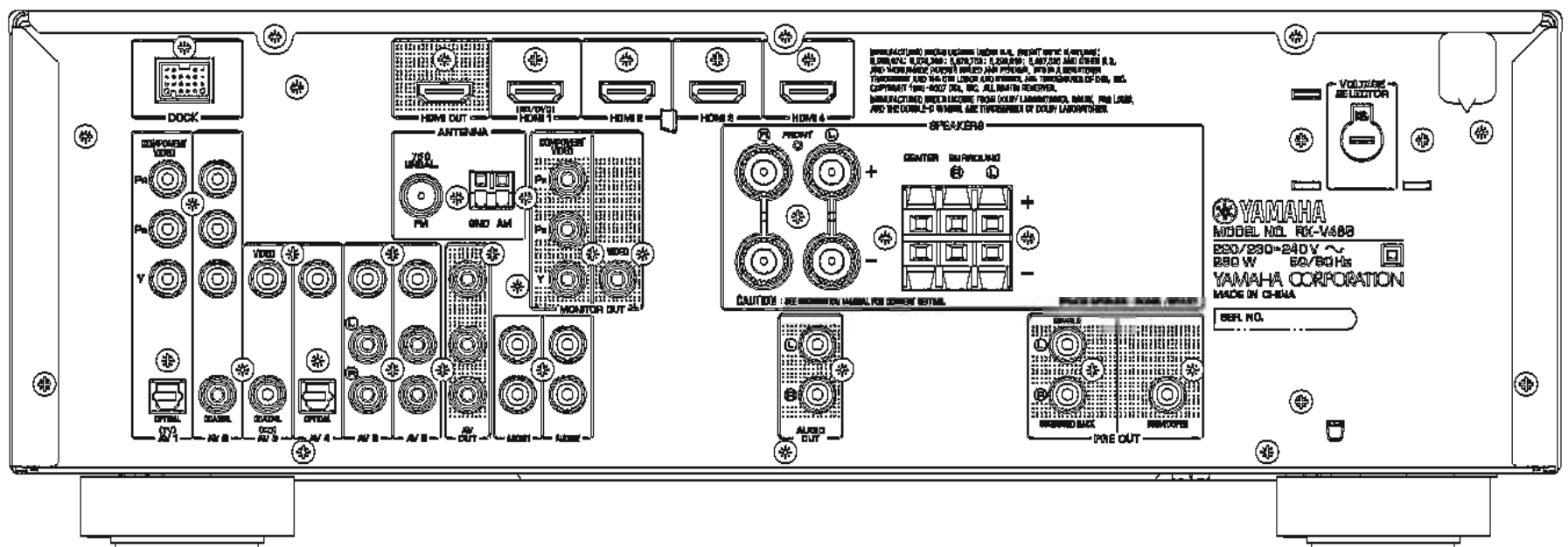

HTR-6240 (U model)

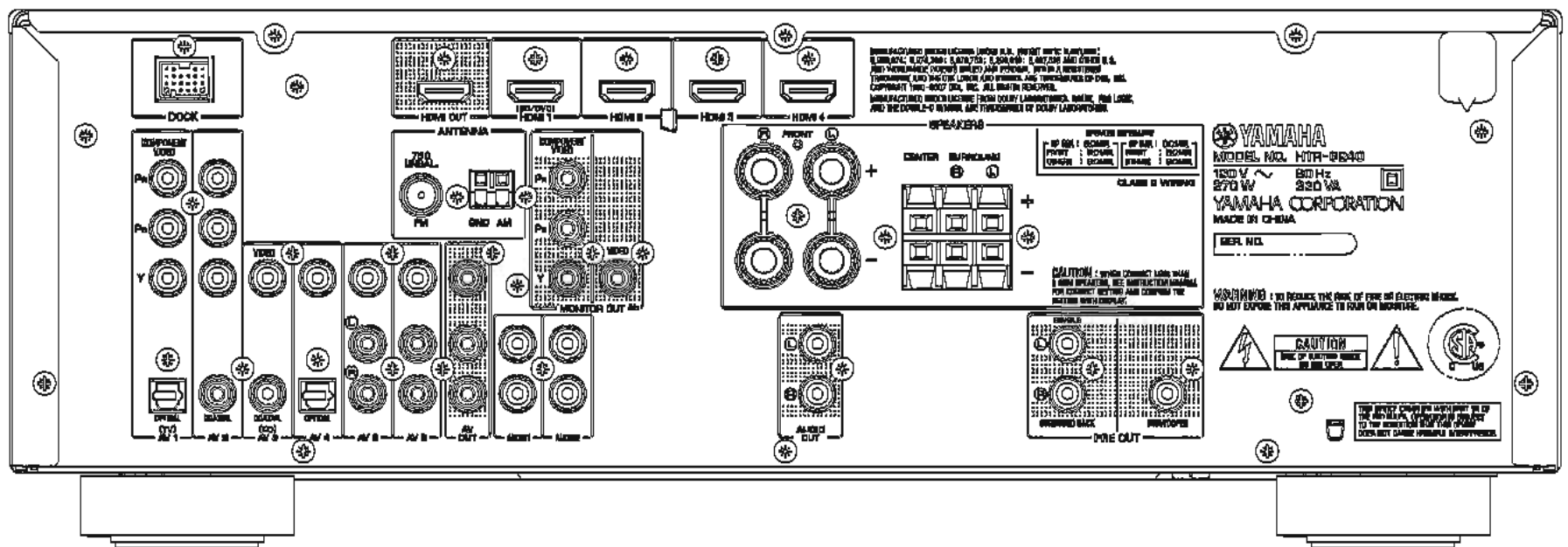

RX-V465/HTR-6240/AX-V465

HTR-6240 (E, F models)

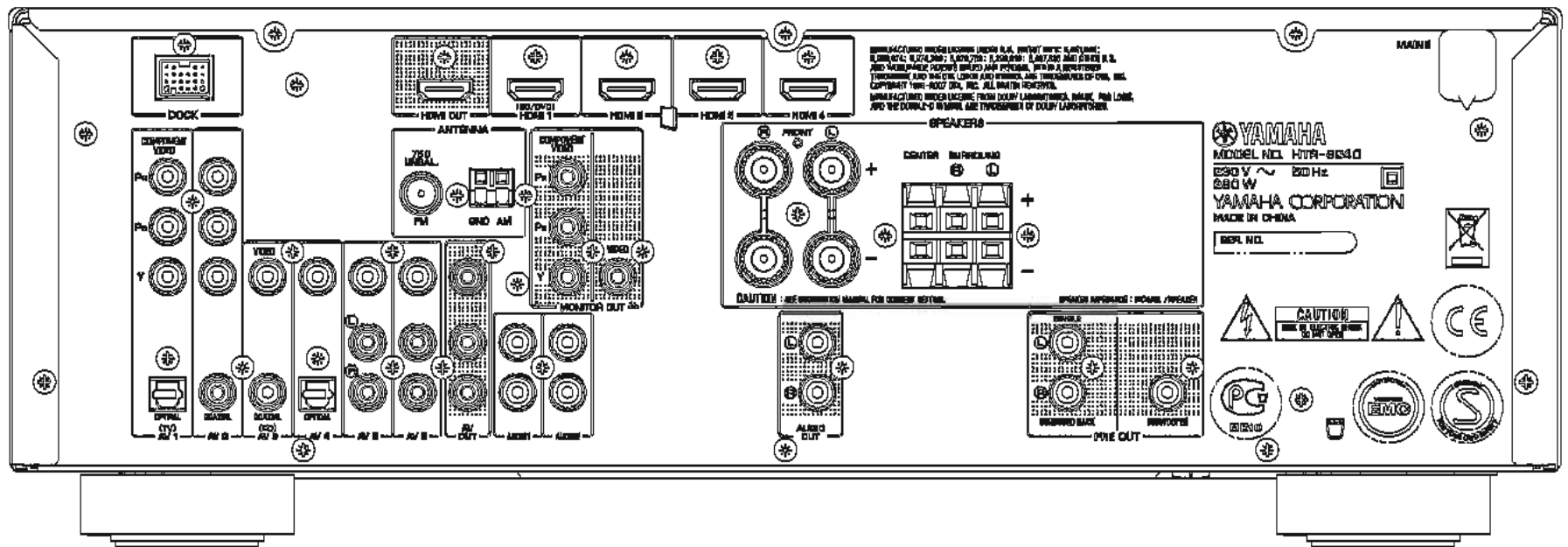

AX-V465 (J model)

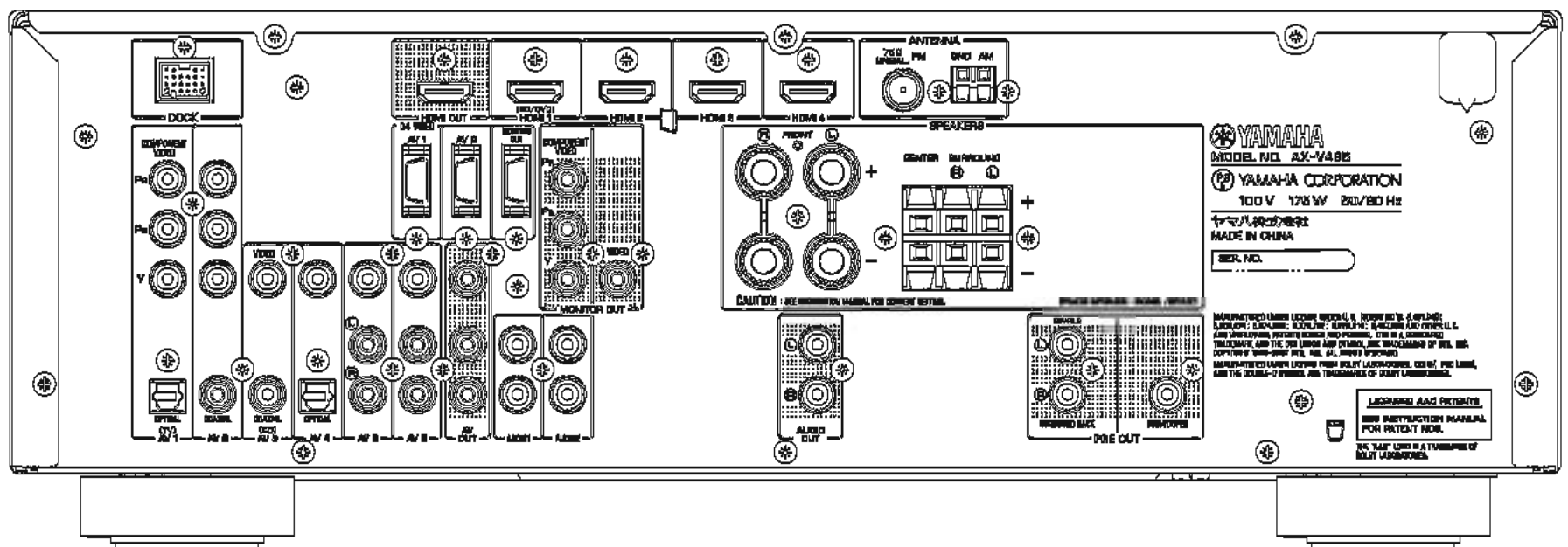

RX-V465/HTR-6240/
AX-V465

■ SPECIFICATIONS / 参考仕様

■ Audio Section / オーディオ部

Minimum RMS Output Power (Power Amp. Section) /

定格出力 (パワーアンプ部)

(1 kHz, 0.9 % THD)

FRONT L/R, CENTER, SURROUND L/R

U, C models (8 ohms) 105 W/ch

R, T, K, A, B, G, E, F, L, J models (6 ohms) 105 W/ch

Maximum Power / 実用最大出力 (JEITA) (1 kHz, 10 % THD, 6 ohms)

[R, T, K, L, J models]

FRONT L/R, CENTER, SURROUND L/R

..... 140 W/ch

MAX. Power Per Channel (1 kHz, 0.7 % THD, 4 ohms)

[B, G, E, F, L models]

FRONT L/R, CENTER, SURROUND L/R

..... 120 W/ch

IEC Power (1 kHz, 0.9 % THD, 8 ohms) [B, G, E, F, L models]

FRONT L/R 105 W/ch

Dynamic Power Per Channel / ダイナミックパワー (IHF)

FRONT L/R drive

U, C models

(8 / 6 / 4 / 2 ohms) 110 / 130 / 160 / 180 W

R, T, K, A, B, G, E, F, L, J models

(- / 6 / 4 / 2 ohms) - / 100 / 130 / 150 W

Dynamic Headroom [U, C models]

8 ohms 0.2 dB

Input Sensitivity/Input Impedance / 入力感度/入力インピーダンス

(1 kHz, 100 W/6 ohms)

AV5 etc. 200 mV / 47 k-ohms

Maximum Input Signal / 最大許容入力 (1 kHz, 0.5 % THD)

AV5 etc. (effect ON) 2.3 V or more

Output Level/Output Impedance / 出力電圧/出力インピーダンス

REC OUT 200 mV/1.2 k-ohms

PRE OUT 1 V/1.2 k-ohms

SUBWOOFER (2 ch stereo and FRONT SP: small)

..... 1 V/1.2 k-ohms

Headphone Jack Rated Output/Output Impedance /

ヘッドホン出力/出力インピーダンス

AV5 etc. input (1 kHz, 50 mV, 8 ohms) 100 mV/470 ohms

Frequency Response / 再生周波数帯域

AV5 etc., FRONT (10 Hz to 100 kHz) 0/-3 dB

Total Harmonic Distortion / 全高調波歪率

AV5, etc. (DIRECT) to FRONT SP OUT (1 kHz, 50 W)

U, C models (8 ohms) 0.06 % or less

R, T, K, A, B, G, E, F, L, J models (6 ohms) 0.06 % or less

Signal to Noise Ratio / 信号対雑音比 (IHF-A network)

AV5, etc. (DIRECT) to SP OUT (Input shorted 250 mV)

..... 100 dB or more

Residual Noise / 残留ノイズ (IHF-A Network)

FRONT L/R to SP OUT 150 μ V or less

Channel Separation / チャンネルセパレーション

AV5, etc. (Input 5.1 k-ohms shorted)

1 kHz / 10 kHz 60 dB or more / 45 dB or more

Volume Control / 可変範囲/ステップ

..... MUTE / -80 dB to +16.5 dB / 0.5 dB step

Tone Control Characteristics / トーンコントロール特性

FRONT L/R

Bass

Boost/Cut \pm 10 dB/2 dB, step 50 Hz

Turnover frequency 350 Hz

Treble

Boost/Cut \pm 10 dB/2 dB, step 20 kHz

Turnover frequency 3.5 kHz

Filter Characteristics / フィルタ特性

FRONT, CENTER, SURROUND small (H.P.F.)

..... fc=40/60/80/90/100/110/120/160/200 Hz, 12 dB/oct.

SUBWOOFER small (L.P.F.)

..... fc=40/60/80/90/100/110/120/160/200 Hz, 24 dB/oct.

■ Video Section / ビデオ部

Composite Video Signal Level / コンポジットビデオ信号

..... 1 Vp-p / 75 ohms

Component Video Signal Level / コンポーネントビデオ信号

Y 1 Vp-p / 75 ohms

Cb/Cr 0.7 Vp-p / 75 ohms

D4 Video Signal / D4 ビデオ信号 [J model]

Y 1 Vp-p / 75 ohms

Cb/Cr 0.7 Vp-p / 75 ohms

Video Maximum Input Level / ビデオ最大許容入力

..... 1.5 Vp-p or more

Video Signal to Noise Ratio / ビデオ信号対雑音比

..... 50 dB or more

Monitor Out Frequency Response / モニター出力周波数帯域

(VIDEO CONV. OFF)

Component video signal level 5 Hz to 60 MHz, -3 dB

D4 video signal / D4 ビデオ信号 (J model) 5 Hz to 60 MHz, -3 dB

■ FM Section / FM 部

Tuning Range / 受信周波数範囲

U, C models 87.5 to 107.9 MHz

R, L models 87.5 to 108.0 MHz / 87.50 to 108.00 MHz

T, K, A, B, G, E, F models 87.50 to 108.00 MHz

J model 76.0 to 90.0 MHz

50 dB Quieting Sensitivity (IHF) (1 kHz, 100 % MOD.)

MONO/STEREO 3 μ V (20.8 dBf)

Signal to Noise Ratio / S/N 比 (IHF)

Mono 74 dB

Stereo 69 dB

Harmonic Distortion / 歪率 (1 kHz)

Mono 0.3 %

Stereo 0.3 %

Antenna Input / アンテナ入力

..... 75 ohms unbalanced

■ AM Section / AM 部

Tuning Range

U, C models 530 to 1,710 kHz

R, L models 530 to 1,710 kHz / 531 to 1,611 kHz

T, K, A, B, G, E, F, J models 531 to 1,611 kHz

Antenna / アンテナ Loop antenna

■ General / 総合

Power Supply / 電源電圧

U, C models	AC 120 V, 60 Hz
R model	AC 110/120/220/230-240 V, 50/60 Hz
T model	AC 220 V, 50 Hz
K model	AC 220 V, 60 Hz
A model	AC 240 V, 50 Hz
B, G, E, F models	AC 230 V, 50 Hz
L model	AC 220/230-240 V, 50/60 Hz
J model	AC 100 V, 50/60 Hz

Power Consumption / 消費電力

U, C models	270 W / 320 VA
R, T, K, A, B, G, E, F, L models	280 W
J model	175 W

Standby Power Consumption (reference data)

HDMI control: OFF / Standby through: OFF	0.2 W or less
HDMI control: ON / Standby through: ON / Repeat	3 W or less
HDMI control: ON / Standby through: ON	1.2 W or less

Maximum Power Consumption [R, L models]

(5 ch drive, 10 % THD)	440 W
------------------------	-------

Dimensions (W x H x D) / 寸法 (幅 × 高さ × 奥行き)

	435 x 151 x 364 mm (17-1/8" x 5-7/8" x 14-3/8")
--	---

Weight / 質量

	8.4 kg (18.5 lbs.)
--	--------------------

Finish / 仕上げ

[RX-V465]	
Gold color	R, T models
Black color	U, C, R, T, K, A, B, G, E, F, L models
Titanium color	K, G, E, F, L models
[HTR-6240]	
Gold color	T model
Black color	U, C, T, K, E, F models
Silver color	E model
[AX-V465]	
Black color	J model

Accessories / 付属品

Remote control	x 1
Battery (R03, AAA, UM-4)	x 2
Indoor FM antenna (1.4 m)	x 1
AM loop antenna (1.0 m)	x 1
Optimizer microphone (6.0 m)	x 1
Sheet RCU (T model)	x 1

* Specifications are subject to change without notice due to product improvements.

※ 参考仕様および外観は予告なく変更されることがあります。

UU.S.A. model	BBritish model
CCanadian model	GEuropean model
RGeneral model	ESouth European model
TChinese model	FRussian model
KKorean model	LSingapore model
AAustralian model	JJapanese model



Manufactured under license from Dolby Laboratories. Dolby, Pro Logic and the double-D symbol are trademarks of Dolby Laboratories.

ドルビーラボラトリーズからの実施権に基づき製造されています。「ドルビー」、「PRO LOGIC」、「Surround EX」およびダブルD記号  は、ドルビーラボラトリーズの商標です。



DTS is a registered trademark and the DTS logos, Symbol, DTS-HD and DTS-HD Master Audio are trademark of DTS, Inc. © 1996-2007 DTS, Inc. All Rights Reserved.

DTS は DTS 社の登録商標です。また、DTS ロゴ、記号、および DTS-HD、DTS-HD Master Audio は DTS 社の商標です。著作権 1996-2007 年 DTS 社。不許複製。

iPod™

"iPod" is a trademark of Apple Inc., registered in the U.S. and other countries.

iPod は、米国およびその他の国々で登録された Apple Inc. の商標または登録商標です。

Bluetooth™

Bluetooth is a registered trademark of Bluetooth SIG and is used by Yamaha in accordance with a license agreement.

Bluetooth は、Bluetooth SIG の登録商標でありヤマハはライセンスに基づき使用しています。

HDMI

"HDMI," the "HDMI" logo and "High-Definition Multimedia Interface" are trademarks, or registered trademarks of HDMI Licensing LLC.

HDMI、HDMI ロゴ、および High-Definition Multimedia Interface は、HDMI Licensing, LLC の商標または登録商標です。

x.v.Color™

"x.v.Color" is a trademark of Sony Corporation.

「x.v.Color」は、ソニー株式会社の商標です。

SILENT™ CINEMA

"SILENT CINEMA" is a trademark of Yamaha Corporation.

「サイレントシネマ™ SILENT CINEMA™」はヤマハ株式会社の登録商標です。



AAC ロゴマーク  はドルビーラボラトリーズの商標です。

• DIMENSIONS / 寸法図

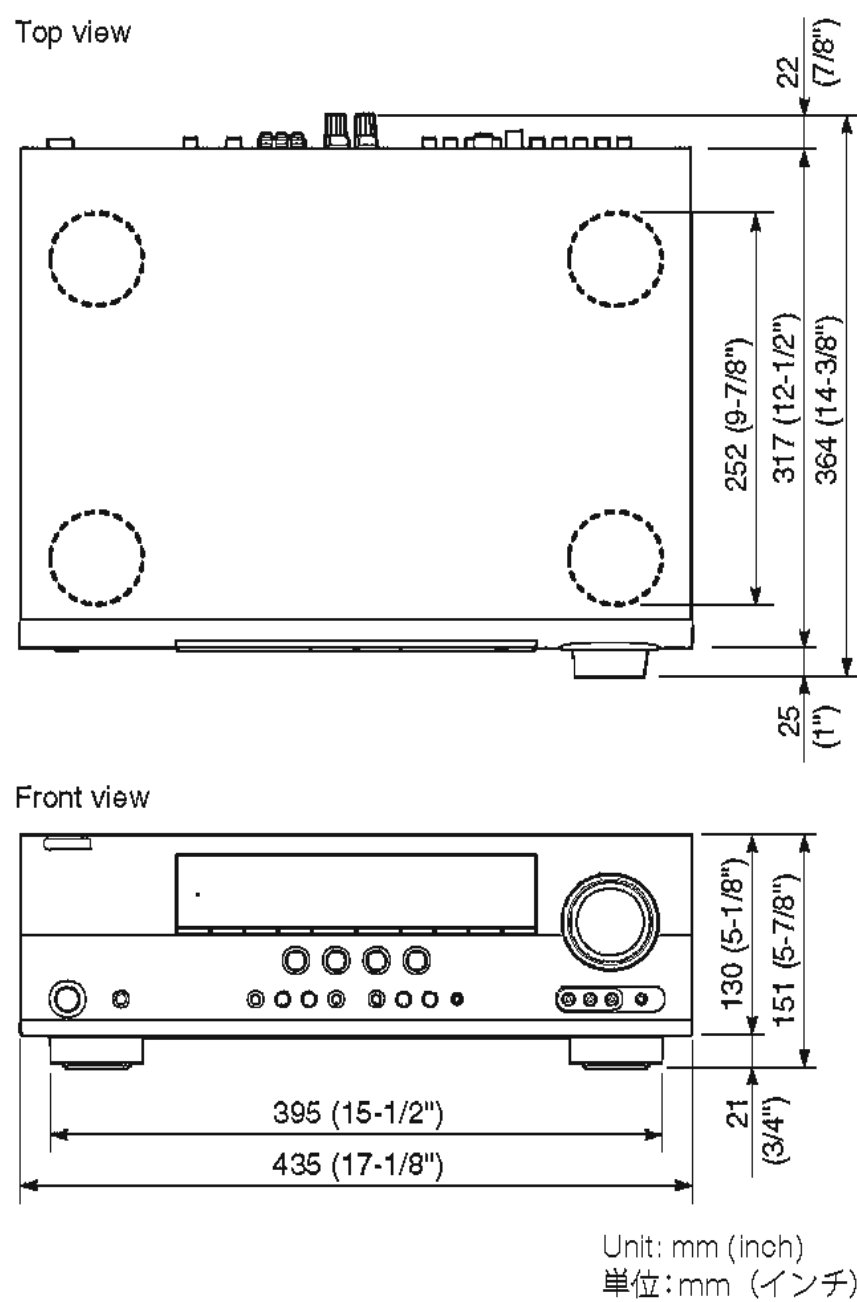

RX-V465/HTR-6240/
AX-V465

• SCENE TEMPLATE

Name	BD/DVD	TV	CD	RADIO
INPUT	HDMI1	AV-1 (Component / Optical)	AV-3 (Video / Coaxial)	TUNER
Sound field mode	STRAIGHT	STRAIGHT	STRAIGHT	MUSIC ENHANCER 5ch Enhancer

• SOUND FIELD PARAMETERS

Category	Program	Parameter																																	
		Decode Type	3D DSP: ON/OFF	DSP Level: -6dB to +3dB	Init. Delay: 1 to 99ms	Room Size: 0.1 to 2.0	Liveness: 0 to 10	Sur. Init. Delay: 1 to 49ms	Sur. Room Size: 0.1 to 2.0	Sur. Liveness: 0 to 10	SB. Init. Delay: 1 to 49ms	SB. Room Size: 0.1 to 2.0	SB. Liveness: 0 to 10	Rev. Time: 1.0 to 5.0s	Rev. Delay: 0 to 250ms	Rev. Level: 0 to 100%	Dialogue Lift: 0 to 5	Center Level: 0 to 100%	Surround L Level: 0 to 100%	Surround R Level: 0 to 100%	Sur.Back Level: 0 to 100%	Presence L Level: 0 to 100%	Presence R Level: 0 to 100%	Direct: Auto/Off	Effect Level: High/Low	Panorama: On/Off	Center Width: 0 to 7	Dimension: -3 to +3	Center Image: 0.0 to 1.0	FOCUS: 0 to 8	TruBass: 0 to 8	Initialize			
MOVIE	Standard	*1	●	●				●	●	●	●	●					●																		●
	Spectacle	*1	●	●	●	●		●	●		●	●					●																		●
	Sci-Fi	*1	●	●	●	●		●	●		●	●					●																		●
	Adventure	*1	●	●	●	●		●	●		●	●					●																		●
	Drama	*1	●	●	●	●		●	●		●	●					●																		●
	Mono Movie			●	●	●	●	●							●	●	●	●																	●
	Sports			●	●	●	●	●				●	●				●																		●
	Action Game			●	●	●	●	●				●	●				●																		●
	Roleplaying Game			●	●	●	●	●				●	●				●																		●
MUSIC	Hall in Munich			●	●	●	●	●								●																		●	
	Hall in Vienna			●	●	●	●	●								●																		●	
	Chamber			●	●	●	●	●						●	●	●	●																	●	
	Cellar Club			●	●	●	●	●								●																		●	
	The Roxy Theatre			●	●	●	●	●						●	●	●	●																	●	
	The Bottom Line			●	●	●	●	●								●																		●	
	Music Video			●	●	●	●	●	●			●	●			●																		●	
STEREO	2ch Stereo																								●									●	
	7ch Stereo																●	●	●	○	●	●											●		
MUSIC ENHANCER	Straight Enhancer																									●								●	
	7ch Enhancer																									●								●	
SUR. DECODE	Surround Decoder	● *2																									△	△	△	▲	■	■	●		
STRAIGHT																																			

- : The parameter to be used varies between when there is one surround pack and when there are two. On the display, the parameter value varies accordingly while the same parameter name appears. / サラウンドパックの数が1つの場合と2つの場合で使用するパラメータは変わるが、パラメータ名は同じ表示でパラメータ値のみを切換えて表す
- △ : Setting is possible only when Pro Logic II x Music (Pro Logic II Music) is selected using decode type. / Decode Type で Pro Logic II x Music (Pro Logic II Music) を選択時のみ設定可
- ▲ : Setting is possible only when Neo:6 Music is selected using decode type. / Decode Type で Neo:6 Music を選択時のみ設定可
- : Setting is possible only when CS II Cinema/Music is selected using decode type. / Decode Type で CS II Cinema/Music を選択時のみ選択可

*1 Decode Type

Decode Type	PL II x Movie	PL II when Surround Back is None. / Surround Back が None の場合は PL II
	Neo:6 Cinema	

*2 Decode Type

Decode Type	Pro Logic	PL II when Surround Back is None. / Surround Back が None の場合は PL II	
	PL II x Movie		
	PL II x Music		PL II when Surround Back is None. / Surround Back が None の場合は PL II
	PL II x Game		PL II when Surround Back is None. / Surround Back が None の場合は PL II
	Pro Logic II z		PL II when Surround Back is None. / Surround Back が None の場合は PL II
	Neo:6 Cinema		
	Neo:6 Music		

• SET MENU TABLE / セットメニュー

MAIN MENU	SUB MENU	PARAMETER	VALUE [INITIAL VALUE]	
1 • Speaker Setup				
1 Auto Setup (YPAO)	Extra SP Assign		[Zone2] / Presence / None	
	EQ Type		[Natural] / Flat / Front	
	Start		[ENTER]: Start	
2 Manual Setup	A) Config	Bass Out	SWFR / Front / [Both]	
		Front	Small / [Large]	
		Center	None / [Small] / Large	
		Sur. LR	None / SMLx1 / [SMLx2] / LRGx1 / LRGx2	
		Sur. B	None / SMLx1 / [SMLx2] / LRGx1 / LRGx2	
		Crossover Freq.	40 / 60 / [80] / 90 / 100 / 110 / 120 / 160 / 200 Hz	
		SWFR Phase	[NO (Normal)] / RE (Reverse)	
	B) Level	FL	-10.0 to +10.0 dB, [0 dB], 0.5 dB step	
		FR		
		C		
		SL		
		SR		
		SBL		
		SBR		
		SW		
	C) Distance	Unit	meters (m) / [feet (ft)]	
		Front L	0.30 to 24.00 m, [3.00 m]	
		Front R		
		Center		
		Sur. L	0.30 to 24.00 m, [2.40 m]	
		Sur. R		
		SBL		
		SBR		
		SWFR		
		Front L	1.0 to 80.0 ft, [10.0 ft]	
		Front R		
		Center		
Sur. L		1.0 to 80.0 ft, [8.0 ft]		
Sur. R				
SBL				
SBR				
SWFR				
D) Equalizer	EQ	Auto PEQ / [GEQ] / Off		
	GEQ		* "GEQ" is available only when "EQ Type Select" is set to "GEQ" / "GEQ" 選択時のみ設定可能	
	Front L	63 Hz 0 dB	-6.0 to +6.0 dB, [0 dB], 0.5 dB step	
	Front R	160 Hz 0 dB		
	Center	400 Hz 0 dB		
	Sur. L	1 kHz 0 dB		
	Sur. R	2.5 kHz 0 dB		
	SBL	6.3 kHz 0 dB		
	SBR	16 kHz 0 dB		
	E) Test Tone			[Off] / On
2 • Sound Setup				
1 Dynamic Range				Min/Auto / STD / [Max]
2 Lipsync	HDMI		[Off] / On	
	Auto		0 to 240 ms, [0 ms], 1 ms step	
	Manual			
3 • Function Setup				
1 HDMI	Control		On / [Off]	
	Standby		On / [Off] (* This menu is available only when "Control" is set to "Off" / "Control : Off" 選択時のみ設定可能)	
	Audio		[Amp] / TV / Amp+TV (* This menu is available only when "Control" is set to "Off" / "Control : Off" 選択時のみ設定可能)	
2 Display	Dimmer		-4 to 0, [0]	
	FL Scroll		[Continue] / Once	
3 Volume	Adptv DRC		Auto / [Off]	
	MaxVol		-30.0 dB to +15.0 dB / [+16.5 dB], 5.0 dB step	
	IniVol		[Off] / Mute / -80.0 to +16.5 dB, 0.5 dB step	

RX-V465/HTR-6240/AX-V465

MAIN MENU	SUB MENU	PARAMETER	VALUE [INITIAL VALUE]	
4 Input Rename			Input is possible to 9 characters / 9 文字まで入力可能 Input possible Character type / 入力可能文字 Capital / 英大文字 : A to Z Small / 英小文字 : a to z Figure / 数字 : 0 to 9 Space / 空白 Marks / 記号 : # * + , - . / : < > ? etc.	
4 • DSP Parameter				
STEREO	7ch Stereo	CT Level	0 to 100 %	
		SL Level		
		SR Level		
		SB Level		
		Initialize		
MUSIC ENHANCER	Straight Enhancer	Effect Level · High	[High] / Low	
		Initialize		
	7ch Enhancer	Effect Level · High	[High] / Low	
		Initialize		
SUR. DECODE	Sur. Decoder	SUR. Pro Logic	Pro Logic / PL Ilx Movie / PL Ilx Music / PL Ilx Game / Neo:6 Cinema / Neo:6 Music / Neural Sur. (U model)	
		Pro Logic Initialize		
		PL Ilx Movie Initialize		
		PL Ilx Music	Panorama	[Off] / On
			Center Width	0 to 7, [3]
			Dimension	-3 to [STD] to +3
		Initialize		
		PL Ilx Game Initialize		
		Neo:6 Cinema Initialize		
		Neo:6 Music	C. Image	0.0 to 1.0, [0.3]
			Initialize	
		Neural Sur. Initialize		
		MOVIE	Standard	SUR. PL Ilx Movie
PL Ilx Movie [1], [4], [8], [11], [16]				
Neo:6 Cinema [1], [4], [8], [11], [16]				
Spectacle	SUR. PL Ilx Movie		PL Ilx Movie / Neo:6 Cinema	
	PL Ilx Movie [1], [3], [4], [7], [8], [16]			
	Neo:6 Cinema [1], [4], [8], [11], [16]			
Sci-Fi	SUR. PL Ilx Movie		PL Ilx Movie / Neo:6 Cinema	
	PL Ilx Movie [1], [3], [4], [7], [8], [16]			
	Neo:6 Cinema [1], [3], [4], [7], [8], [16]			
Adventure	SUR. PL Ilx Movie		PL Ilx Movie / Neo:6 Cinema	
	PL Ilx Movie [1], [3], [4], [7], [8], [16]			
	Neo:6 Cinema [1], [3], [4], [7], [8], [16]			
Drama	SUR. PL Ilx Movie		PL Ilx Movie / Neo:6 Cinema	
	PL Ilx Movie [1], [3], [4], [7], [8], [16]			
	Neo:6 Cinema [1], [3], [4], [7], [8], [16]			
Mono Movie	[1], [2], [6], [10], [13], [14], [15], [16]			
Sports	[1], [3], [4], [7], [8], [16]			
Action Game	[1], [3], [4], [7], [8], [16]			
Roleplaying Game	[1], [3], [4], [7], [8], [16]			
MUSIC	Hall in Munich		[1], [2], [6], [10], [16]	
	Hall in Vienna	[1], [2], [6], [10], [16]		
	Chamber	[1], [2], [10], [13], [14], [15], [16]		
	Cellar Club	[1], [2], [6], [10], [16]		
	The Roxy Theatre	[1], [2], [6], [10], [13], [14], [15], [16]		
	The Bottom Line	[1], [2], [6], [10], [16]		
	Music Video	[1], [3], [4], [7], [8], [16]		
STEREO	2ch Stereo	Direct	[Auto] / Off	
		Initialize		

MAIN MENU	SUB MENU	PARAMETER	VALUE [INITIAL VALUE]
	[1]	DSP Level	-6 to +3 dB, [0 dB]
	[2]	Init. Delay	1 to 99 ms
	[3]	P. Init. Dly	
	[4]	S. Init. Dly	1 to 49 ms
	[6]	Room Size	0.1 to 2.0
	[7]	P. Room Size	
	[8]	S. Room Size	
	[10]	Liveness	0 to 10
	[11]	S. Liveness	
	[13]	Rev. Time	1.0 to 5.0 s
	[14]	Rev. Delay	0 to 250 ms
	[15]	Rev. Level	0 to 100 %
	[16]	Initialize	
5 • Memory Guard			[Off] / On

INTERNAL VIEW

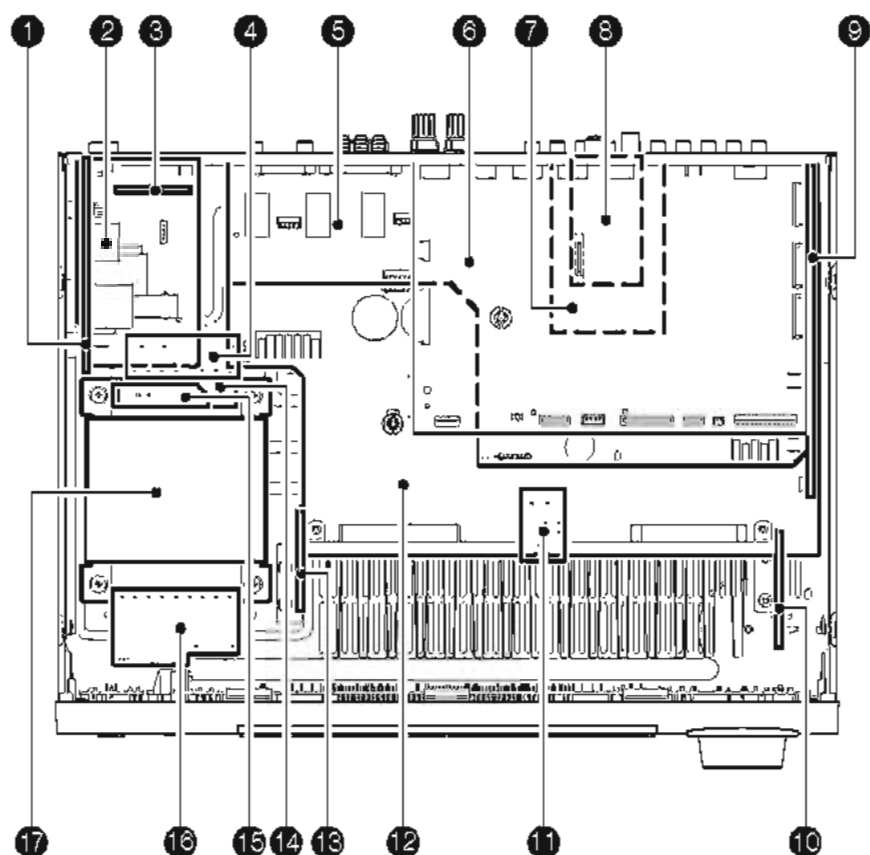

- ① VIDEO (2) P.C.B.
- ② VIDEO (3) P.C.B.
- ③ MAIN (3) P.C.B. (R, L models)
- ④ MAIN (2) P.C.B.
- ⑤ VIDEO (1) P.C.B.
- ⑥ DIGITAL P.C.B.
- ⑦ VIDEO (8) P.C.B. (J model)
- ⑧ AM/FM TUNER
- ⑨ OPERATION (2) P.C.B.
- ⑩ OPERATION (10) P.C.B.
- ⑪ MAIN (5) P.C.B.
- ⑫ MAIN (1) P.C.B.
- ⑬ MAIN (6) P.C.B.
- ⑭ MAIN (4) P.C.B. (R, L models)
- ⑮ VIDEO (7) P.C.B. (U, C, T, K, A, B, G, E, F models)
- ⑯ VIDEO (6) P.C.B.
- ⑰ POWER TRANSFORMER
- ⑱ OPERATION (6) P.C.B.
- ⑲ OPERATION (3) P.C.B.
- ⑳ OPERATION (1) P.C.B.
- ㉑ OPERATION (7) P.C.B.

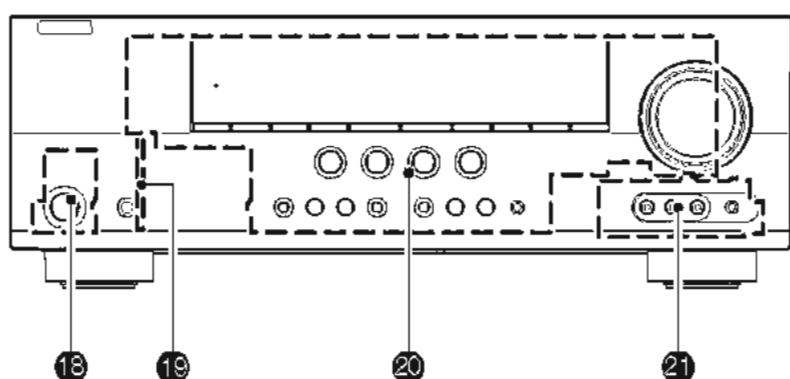

SERVICE PRECAUTIONS / サービス時の注意事項

Safety measures

- Some internal parts in this product contain high voltages and are dangerous.
Be sure to take safety measures during servicing, such as wearing insulating gloves.
- Note that positions indicated below are dangerous even after the power is turned off because an electric charge remains and a high voltage continues to exist there.
Before starting any repair work, perform discharge by connecting a discharge resistor (5k-ohms/10W) between terminals at following positions.
The time required for discharging is about 30 seconds.
C3703 on VIDEO (2) P.C.B.
Refer to "PRINTED CIRCUIT BOARDS: VIDEO (2) P.C.B."

安全対策

- この製品の内部には高電圧部分があり危険です。修理の際は、絶縁性の手袋を使用するなどの安全対策を行ってください。
- 下記箇所には電源を OFF にした後も電荷が残り、高電圧が維持されており危険です。
修理作業前に放電用抵抗 (5 k Ω /10 W) を下記箇所の端子間に接続して放電してください。
放電所用時間は約 30 秒間です。
VIDEO (2) P.C.B. の C3703
"PRINTED CIRCUIT BOARDS : VIDEO (2) P.C.B." を参照してください。

■ DISASSEMBLY PROCEDURES / 分解手順

(Remove parts in the order as numbered.)
Disconnect the power cable from the AC outlet.

(番号順に部品を取り外してください。)
AC電源コンセントから、電源コードを抜いてください。

1. Removal of Top Cover

- Remove 4 screws (①) and 5 screws (②). (Fig. 1)
- Slide the top cover rearward to remove it. (Fig. 1)

1. トップカバーの外し方

- ①のネジ4本、②のネジ5本を外します。(Fig. 1)
- トップカバーを後方へスライドさせ、取り外します。(Fig. 1)

2. Removal of Front Panel Unit

- Remove screw (③), and remove W4001. (Fig. 1)
- Remove 2 screws (④), and remove W4002 and W4403. (Fig. 1)
- Remove 4 screws (⑤). (Fig. 1)
- Remove CB20, CB461 and CB477. (Fig. 1)
- Unlock and remove CB333. (Fig. 1)
- Release 2 hooks, and remove the front panel unit. (Fig. 1)

2. フロントパネルユニットの外し方

- ③のネジ1本を外し、W4001を取り外します。(Fig. 1)
- ④のネジ2本を外し、W4002、W4403を取り外します。(Fig. 1)
- ⑤のネジ4本を外します。(Fig. 1)
- CB20、CB461、CB477を外します。(Fig. 1)
- ロックを外し、CB333を外します。(Fig. 1)
- フック2箇所を外し、フロントパネルユニットを取り外します。(Fig. 1)

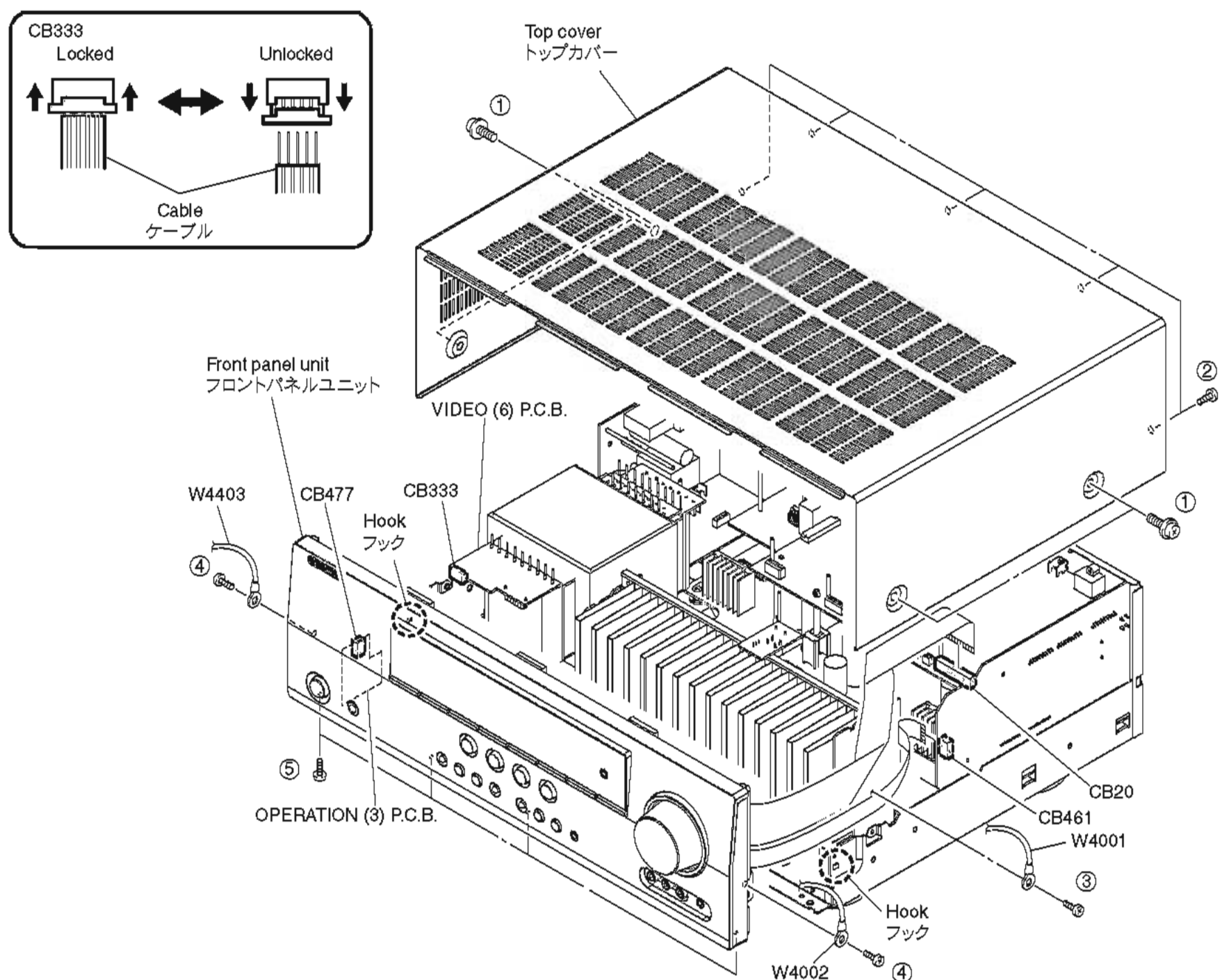

Fig. 1

3. Removal of DIGITAL P.C.B.

- a. Remove 2 screws (⑥) and 5 screws (⑦). (Fig. 2)
- b. Remove screw (⑧). (Fig. 2)
- c. Remove CB7 and CB25. (Fig. 2)
- d. Unlock and remove CB22-24. (Fig. 2)
- e. Release hook. (Fig. 2)
- f. Remove the DIGITAL P.C.B. which is connected directly to the OPERATION (2) P.C.B. with board-to-board connectors. (Fig. 2)

4. Removal of AMP Unit

- a. Remove 3 screws (⑨) and 4 screws (⑩). (Fig. 2)
- b. Remove 3 screws (⑪). (Fig. 2)
- c. Remove the amp unit. (Fig. 2)

3. DIGITAL P.C.B. の外し方

- a. ⑥のネジ2本、⑦のネジ5本を外します。(Fig. 2)
- b. ⑧のネジ1本を外します。(Fig. 2)
- c. CB7、CB25を外します。(Fig. 2)
- d. ロックを外し、CB22～24を外します。(Fig. 2)
- e. フック1箇所を外します。(Fig. 2)
- f. DIGITAL P.C.B.を取り外します。ただし、DIGITAL P.C.B.はOPERATION (2) P.C.B.に基板対基板コネクタで直接接続されています。(Fig. 2)

3. アンプユニットの外し方

- a. ⑨のネジ3本、⑩のネジ4本を外します。(Fig. 2)
- b. ⑪のネジ3本を外します。(Fig. 2)
- c. アンプユニットを取り外します。(Fig. 2)

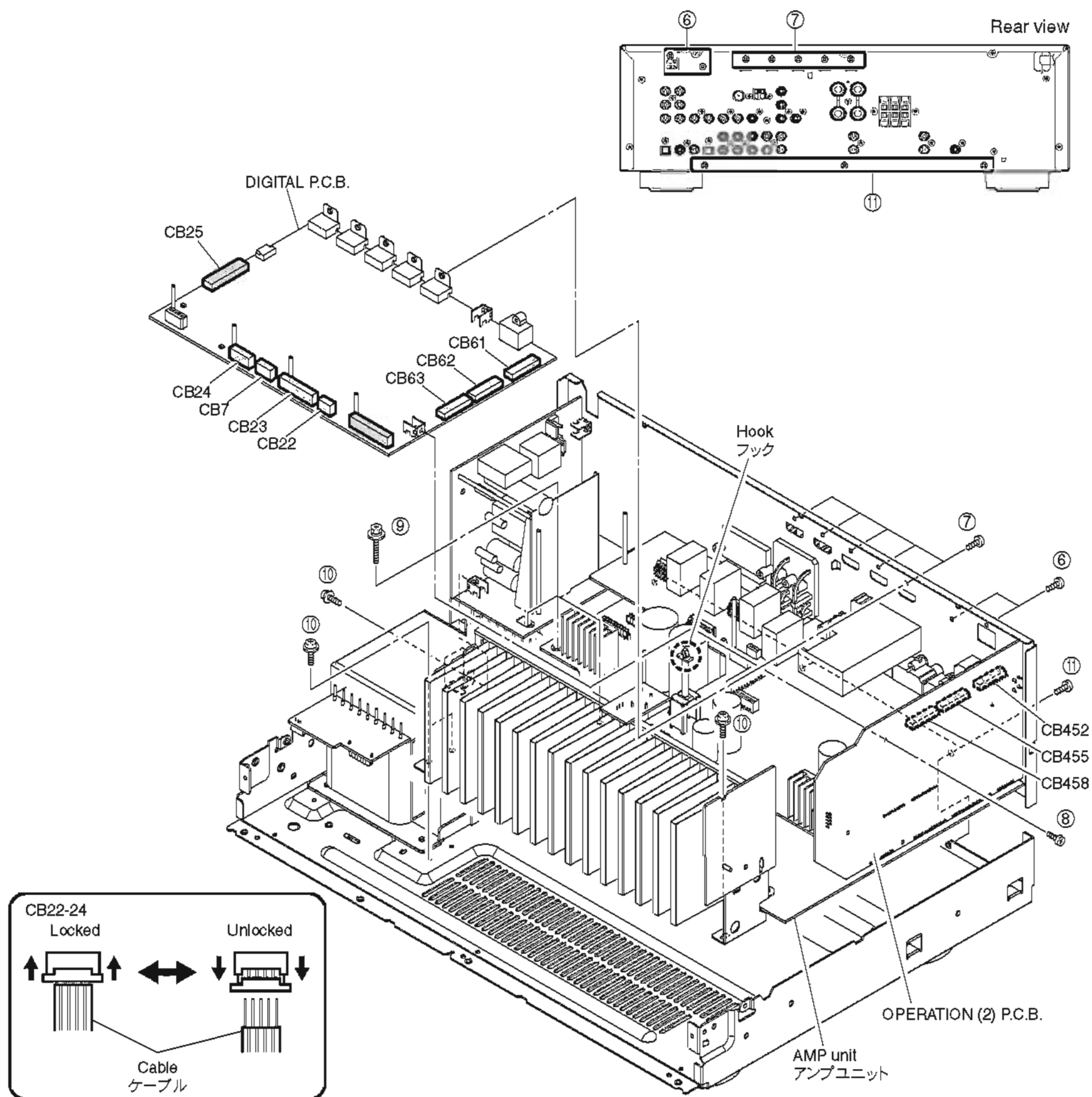

Fig. 2

When checking the P.C.B.s:

- Place the P.C.B.s (with rear panel) upright. (Fig. 3)
- Connect the ground points of the heat sink, rear panel and MAIN (1) P.C.B. (G1000) to the chassis with a ground lead or the like. (Fig. 3)
- When connecting the flexible flat cable, be careful with polarity.
- Reconnect all cables (connectors) that have been disconnected.

Be sure to use the extension cable for servicing for the following section.

DIGITAL P.C.B. CB20 to OPERATION (1) P.C.B. CB401:
MF125400 (25P, 400mm, P=1.25)

OPERATION (1) P.C.B. CB402 to OPERATION (2) P.C.B. CB461:
MF109400 (9P, 400mm, P=1.25)

P.C.B. をチェックする場合には：

- リアパネルと一緒に P.C.B. を立ち上げて置きます。(Fig. 3)
- ヒートシンク、リアパネル、MAIN (1) P.C.B. の G1000 のアースをリード線等でシャーシに接続してください。(Fig. 3)
- フラットケーブルを接続する際、極性に注意してください。
- 外したケーブル (コネクタ) をすべて接続します。ただし次の区間は、サービス用延長ケーブルを使用してください。

DIGITAL P.C.B. CB20 ~ OPERATION (1) P.C.B. CB401 :
MF125400 (25P、400mm、P=1.25)

OPERATION (1) P.C.B. CB402 ~ OPERATION (2) P.C.B. CB461 :
MF109400 (9P、400mm、P=1.25)

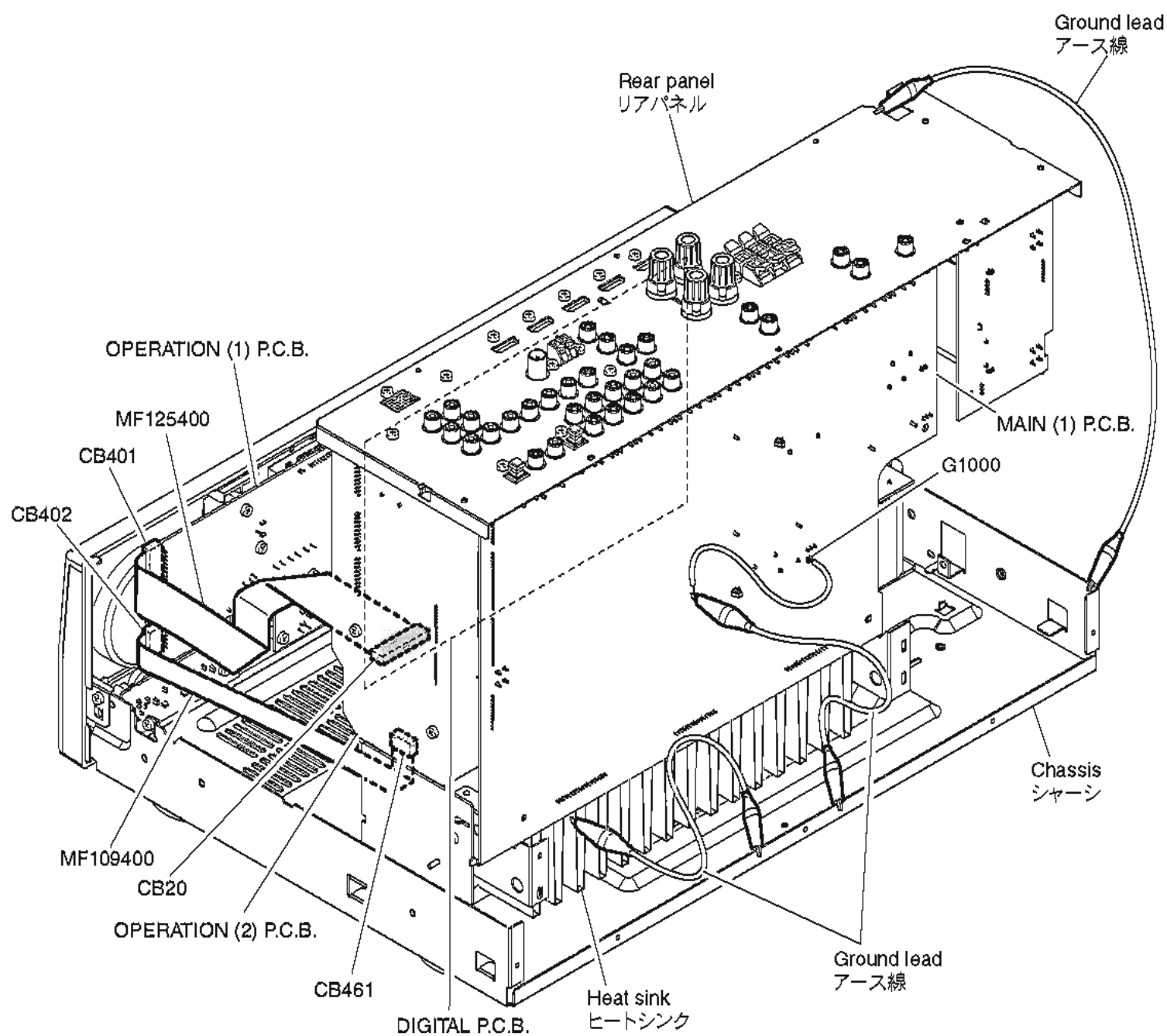

Fig. 3

RX-V465/HTR-6240/
AX-V465

■ UPDATING FIRMWARE / ファームウェアの書き込み

Note) The user memories (sound field parameters, system memory, tuner presetting, etc.) are kept stored even when you write the firmware.

注意) ファームウェアの書き込みを行っても、ユーザーメモリー（音場プログラムのパラメーターやシステムメモリー、チューナープリセット等）は保持されます。

When replacing the following parts, be sure to write the latest firmware.

下記の部品をサービス部品に交換した場合、最新のファームウェアの書き込みを行ってください。

Replaced parts	Writing method using the CD / CD を使用して書き込む方法	Writing method using PC (RS232C) / PC (RS232C) を使用して書き込む方法
DIGITAL P.C.B.	yes	yes
IC20 (Main microprocessor) of DIGITAL P.C.B.	no	yes
IC49 (TI (DSP) flash ROM) of DIGITAL P.C.B.	yes	yes

● Confirmation of firmware version and checksum

Before and after writing firmware, check the firmware version and checksum by using the self-diagnostic function menu.

Start up the self-diagnostic function and select "25. ROM VER/SUM/PORT" menu. (See "SELF DIAGNOSTIC FUNCTION")

Using the sub-menu, have the firmware version and checksum displayed, and note down them.

● ファームウェアのバージョンとチェックサムの確認

ファームウェアの書き込みの前後に、ファームウェアのバージョンとチェックサムをダイアグメニューで確認します。

ダイアグを起動し、“25. ROM VER/SUM/PORT”メニューを選択します。（ダイアグ（自己診断機能）参照）

サブメニューでファームウェアのバージョンとチェックサムを表示し、それらを書きとめます。

25. ROM VER/SUM/PORT

Firmware version

Ver: 0022

The firmware version of microprocessor (IC20 DIGITAL P.C.B.) is displayed.
マイコン (IC20 DIGITAL P.C.B.) のファームウェアバージョンが表示されます。

All checksum

Sum: 162E

The checksum value of microprocessor (IC20 DIGITAL P.C.B.) is displayed.
マイコン (IC20 DIGITAL P.C.B.) のチェックサムが表示されます。

TI (DSP) FLASH ROM version

TiVer: 02.04r1

The firmware version of TI (DSP) FLASH ROM (IC49 DIGITAL P.C.B.) is displayed.
TI (DSP) FLASH ROM (IC49 DIGITAL P.C.B.) のファームウェアバージョンが表示されます。

TI (DSP) FLASH ROM checksum

TiSum: 2F3C6C1A

The checksum value of TI (DSP) FLASH ROM (IC49 DIGITAL P.C.B.) is displayed.
TI (DSP) FLASH ROM (IC49 DIGITAL P.C.B.) のチェックサムが表示されます。

MODEL/DESTINATION

V4 000 U 027

The model name and destination are displayed.
モデル名、仕向け先が表示されます。

VERIFY error

Verify 000

Not applied to these models.
このモデルには適用されません。

Writing method using the CD● **Required Tools**

- DVD or CD player (with DIGITAL OUTPUT (OPTICAL or COAXIAL) jack)
- Optical cable (when OPTICAL jack is used)
- Digital audio pin cable (when COAXIAL jack is used)
- Firmware CD
 - * To make the firmware CD, download the latest firmware from the specified download source.

CD を使用して書き込む方法● **必要なツール**

- DVD または CD プレーヤー (DIGITAL OUTPUT (OPTICAL または COAXIAL) 端子付き)
- 光ファイバーケーブル (OPTICAL 端子使用時)
- デジタル音声ピンケーブル (COAXIAL 端子使用時)
- ファームウェア CD
 - ※ ファームウェア CD は、最新のファームウェアを指定のダウンロード先からダウンロードして製作してください。

● **Connection**

Connect this unit and DVD/CD player as shown below. (Fig. 1)

● **接続**

本機とDVD/CDプレーヤーを下記のように接続します。(Fig. 1)

Example of OPTICAL Jack / OPTICAL 端子使用例

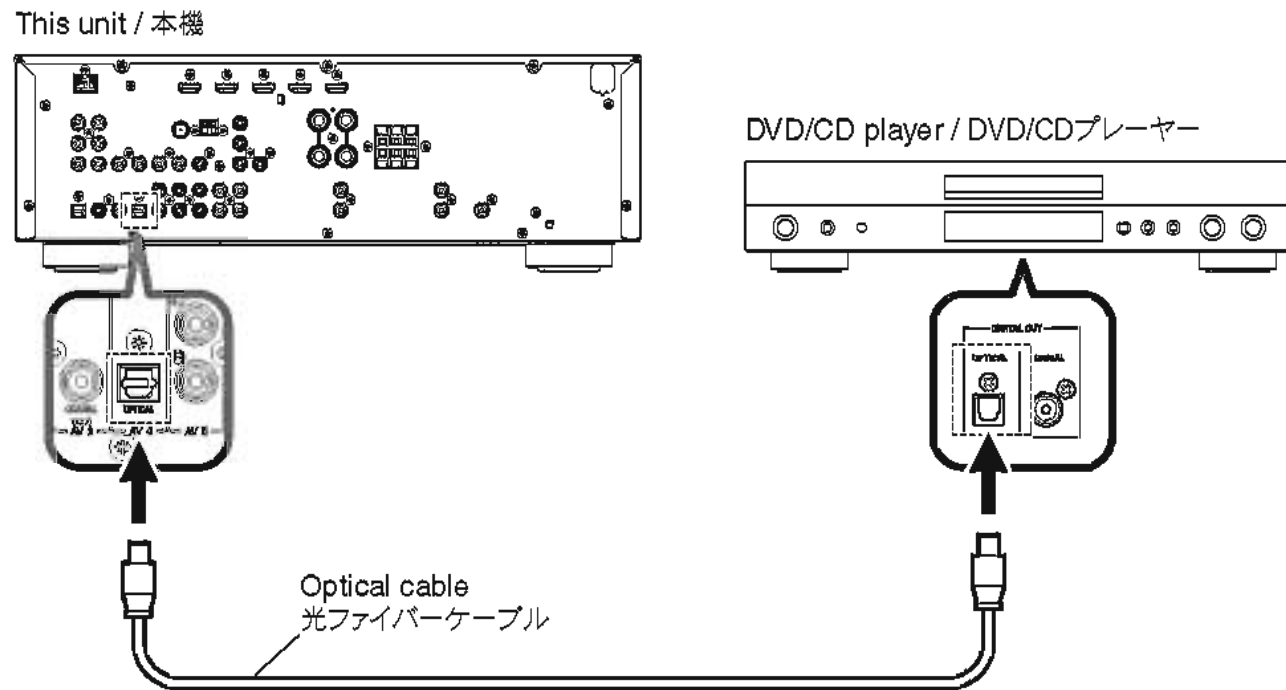

Example of COAXIAL Jack / COAXIAL 端子使用例

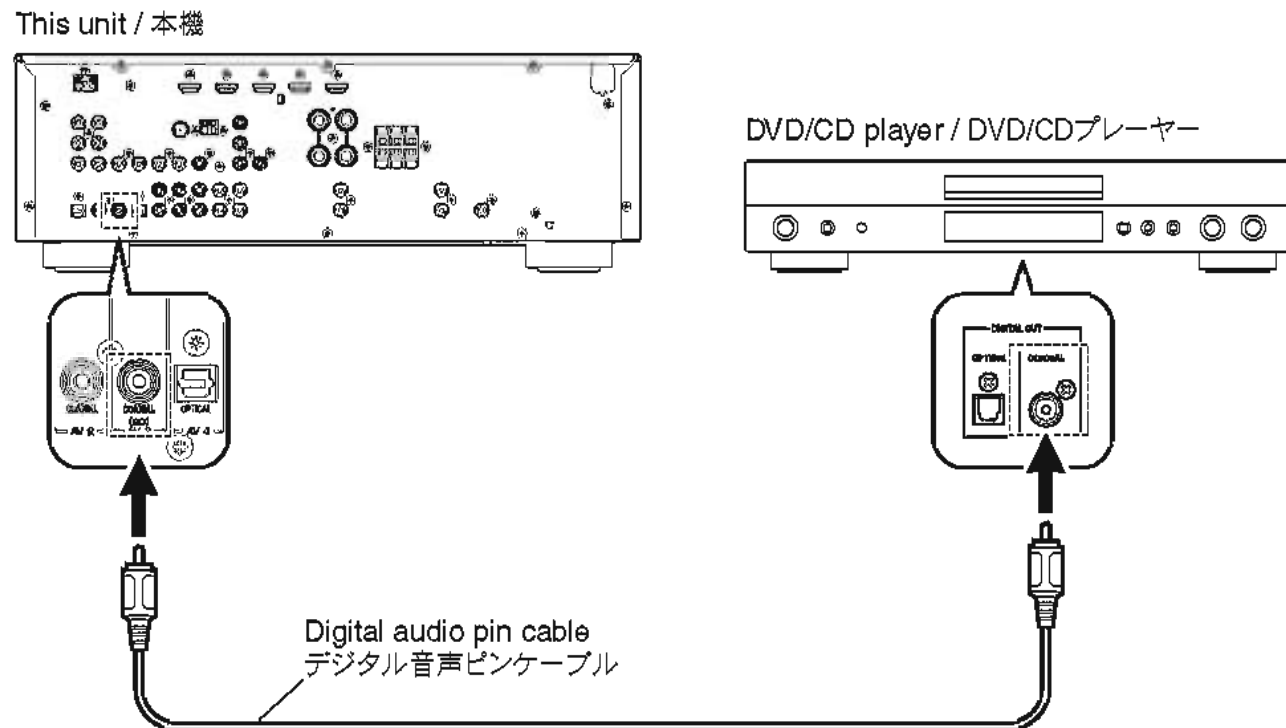

Fig. 1

● Operation Procedures

1. While pressing the "STRAIGHT" key of this unit, connect the power cable of this unit to the AC outlet. (Fig. 2)
The FIRMWARE UPDATE mode is activated and "CDDA Upgrader" is displayed. (Fig. 2)

● 操作手順

1. 本機の "STRAIGHT" キーを押しながら、本機の電源コードを AC コンセントに接続します。(Fig. 2)
FIRMWARE UPDATE モードが起動し、"CDDA Upgrader" が表示されます。(Fig. 2)

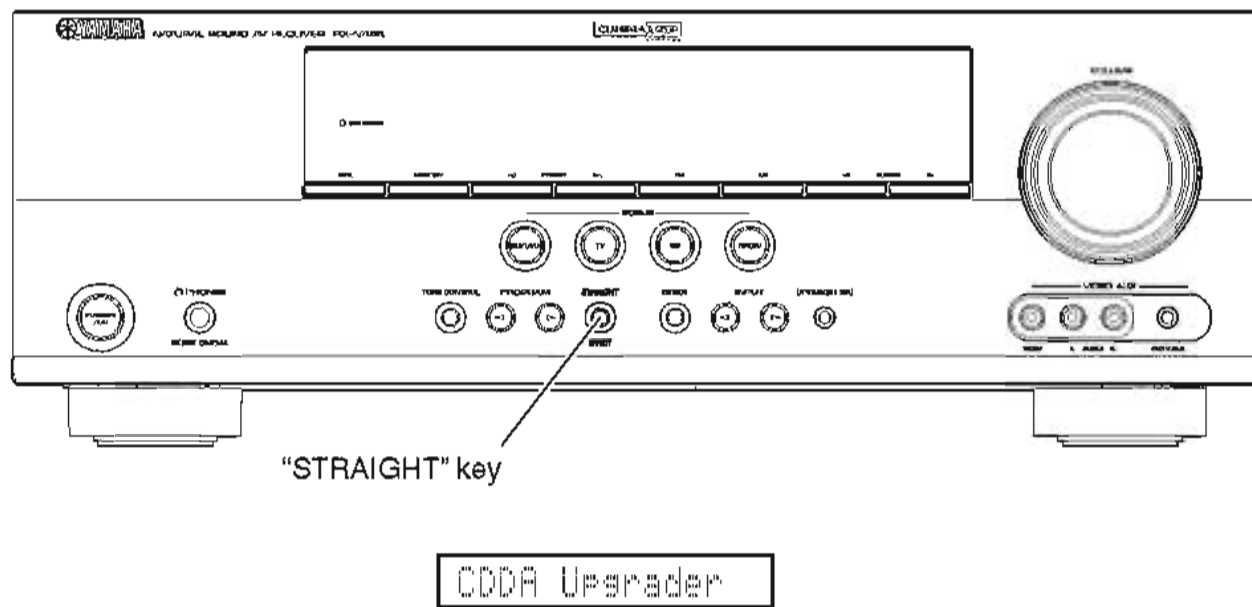

Fig. 2

2. Connect the power cable of DVD/CD player to the AC outlet.
3. Press the "STANDBY/ON" key of the DVD/CD player to turn on the power.
4. Press the "EJECT" key of the DVD/CD player to open the disc tray.
5. Put the firmware CD on the disc tray and close the disc tray.
6. Press the "PLAY" key of the DVD/CD player.
Then writing of the firmware is started. (Fig. 3)
7. When writing of the firmware is completed, "Update Success", "Please..." and "Power off!!" are displayed repeatedly. (Fig. 3)

2. DVD/CD プレーヤーの電源コードを AC コンセントに接続します。
3. DVD/CD プレーヤーの "STANDBY/ON" キーを押して電源を入れます。
4. DVD/CD プレーヤーの "EJECT" キーを押し、ディスクトレイを開きます。
5. ファームウェア CD をディスクトレイに載せ、ディスクトレイを閉じます。
6. DVD/CD プレーヤーの "PLAY" キーを押します。
ファームウェアの書き込みが開始されます。(Fig. 3)
7. ファームウェアの書き込み完了後、"Update Success"、"Please..."、"Power off!!" が繰り返し表示されます。(Fig. 3)

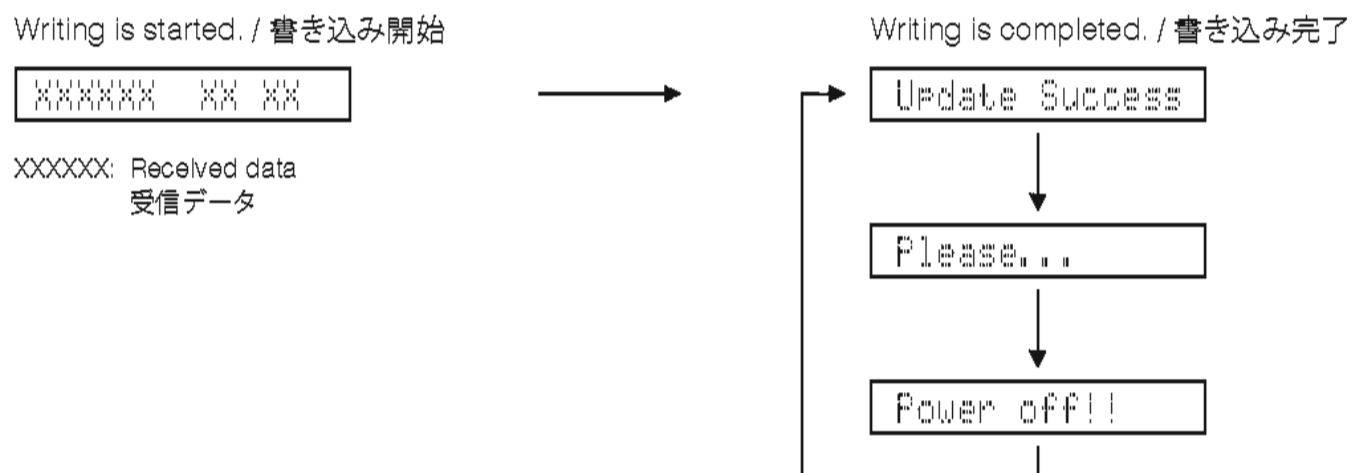

Fig. 3

- * When the version of the firmware to be written is the same as the one existing in this unit, "Same Version", "Please..." and "Power off!!" are displayed repeatedly. (Upgrading is not necessary.)

If the display remains unchanged for longer than 10 seconds after starting the firmware CD play procedure, perform the firmware CD play procedure again from the beginning.

If "FILE CORRUPTED" is displayed after "XXXXXX", make sure that the written data is not corrupted and perform Steps 1 to 7 of "Writing method using the CD" again.

If "Upgrade Failed" is displayed, perform Steps 1 to 7 of "Operation Procedures" again.

- Press the "STOP" key of the DVD/CD player.
- Press the "EJECT" key of the DVD/CD player to open the disc tray.
- Remove the firmware CD from the disc tray and close the disc tray.
- Press the "STANDBY/ON" key of the DVD/CD player to turn off the power.
- Press the "STANDBY/ON" key of this unit to turn off the power.
- Start up the self-diagnostic function and select "25. ROM VER/SUM/PORT" menu.
Using the sub-menu, have the firmware version and checksum displayed, and then check that they are the same as written ones.
 - * When the displayed firmware version and checksum are different from written ones, perform the "Writing method using the CD" all over again.
- Press the "STANDBY/ON" key of this unit to turn off the power.

- ※ 本機に既存のファームウェアと、書き込もうとしているファームウェアのバージョンが同じ場合、"Same Version"、"Please..."、"Power off!!" の表示が繰り返されます。(バージョンアップの必要はありません。)

ファームウェア CD の再生開始後、10 秒以上経過してもディスプレイ表示が変わらない場合、ファームウェア CD の再生を最初からやり直してください。

"XXXXXX" の後に、"FILE CORRUPTED" が表示された場合、書き込みデータが破損していないかを確認し、"CD を使用して書き込む方法" の 1 から 7 までをもう一度やり直してください。

"Upgrade Failed" が表示された場合、"操作手順" の 1 から 7 までをもう一度やり直してください。

- DVD/CD プレーヤーの "STOP" キーを押します。
- DVD/CD プレーヤーの "EJECT" キーを押し、ディスクトレイを開きます。
- ファームウェア CD をディスクトレイから取り出し、ディスクトレイを閉じます。
- DVD/CD プレーヤーの "STANDBY/ON" キーを押して電源を切ります。
- 本機の "STANDBY/ON" キーを押して電源を切ります。
- ダイアグを起動し、"25. ROM VER/SUM/PORT" メニューを選択します。
サブメニューでファームウェアのバージョンとチェックサムを表示し、それらが書き込んだものと同じであることを確認します。
 - ※ 表示されたファームウェアのバージョンとチェックサムが、書き込まれたものと異なる場合、「CD を使用して書き込む方法」をもう一度やり直してください。
- 本機の "STANDBY/ON" キーを押して電源を切ります。

Writing method using PC (RS232C)

● Required Tools

- Firmware downloader program
For microprocessor: DSP_FLASHER_v3.0.exe
For DSP (TI flash ROM):
DSP_FLASHER Ver2.7.exe
- Firmware
For microprocessor: VX65xxxx.mot
For DSP (TI flash ROM):
Vx65_data1_verxxxxxr.hex
- RS232C cross cable "D-sub 9 pin female"
(Specifications)

Pin No.2 RxD	—————	Pin No.2 RxD
Pin No.3 TxD	—————	Pin No.3 TxD
Pin No.5 GND	—————	Pin No.5 GND
Pin No.7 RTS	—————	Pin No.7 RTS
Pin No.8 CTS	—————	Pin No.8 CTS
- RS232C conversion adaptor (Part No.: WR492800)

● Preparation and precautions

- Download the firmware downloader program and the firmware from the specified source to the same folder of the PC.
- Prepare the above specified RS232C cross cable.
- While writing the firmware, keep the other application software on the PC closed.
It is also recommended to keep the software on the task tray closed as well.

PC (RS232C) を使用して書き込む方法

● 必要なツール

- ファームウェア書き込み用プログラム
マイコン用: DSP_FLASHER_v3.0.exe
DSP (TI flash ROM) 用:
DSP_FLASHER Ver2.7.exe
- ファームウェア
マイコン用: VX65xxxx.mot
DSP (TI flash ROM) 用:
Vx65_data1_verxxxxxr.hex
- RS232C クロスケーブル "D-sub 9pin メス"
(仕様)

Pin No.2 RxD	—————	Pin No.2 RxD
Pin No.3 TxD	—————	Pin No.3 TxD
Pin No.5 GND	—————	Pin No.5 GND
Pin No.7 RTS	—————	Pin No.7 RTS
Pin No.8 CTS	—————	Pin No.8 CTS
- RS232C 変換アダプター (部品番号: WR492800)

● 準備と注意

- 指定のダウンロード先から、ファームウェア書き込み用プログラムとファームウェアを、PC の同じフォルダへダウンロードしてください。
- RS232C クロスケーブルは必ず上記仕様のものを用意してください。
- 書き込み時は、PC 上の他のアプリケーションソフトは閉じてください。
さらに、タスクトレイ上にあるソフトも閉じておくことを推奨します。

● **Connection**

1. Remove the top cover. (See "DISASSEMBLY PROCEDURES")
2. Connect the writing port (CB27 of DIGITAL P.C.B.) of this unit to the serial port (RS232C) of the PC with RS232C cross cable, RS232C conversion adaptor and flexible flat cable as shown below. (Fig. 1)
3. Set the switch (SW7) of RS232C conversion adaptor as shown below. (Fig. 1)

● **接続**

1. トップカバーを取り外します。（“分解手順”参照）
2. 本機の書き込み用ポート（DIGITAL P.C.B. CB27）とPCのシリアルポート（RS232C）を下記のように接続します。（Fig.1）
3. RS232C変換アダプターのスイッチ（SW7）を下記のように設定します。（Fig.1）

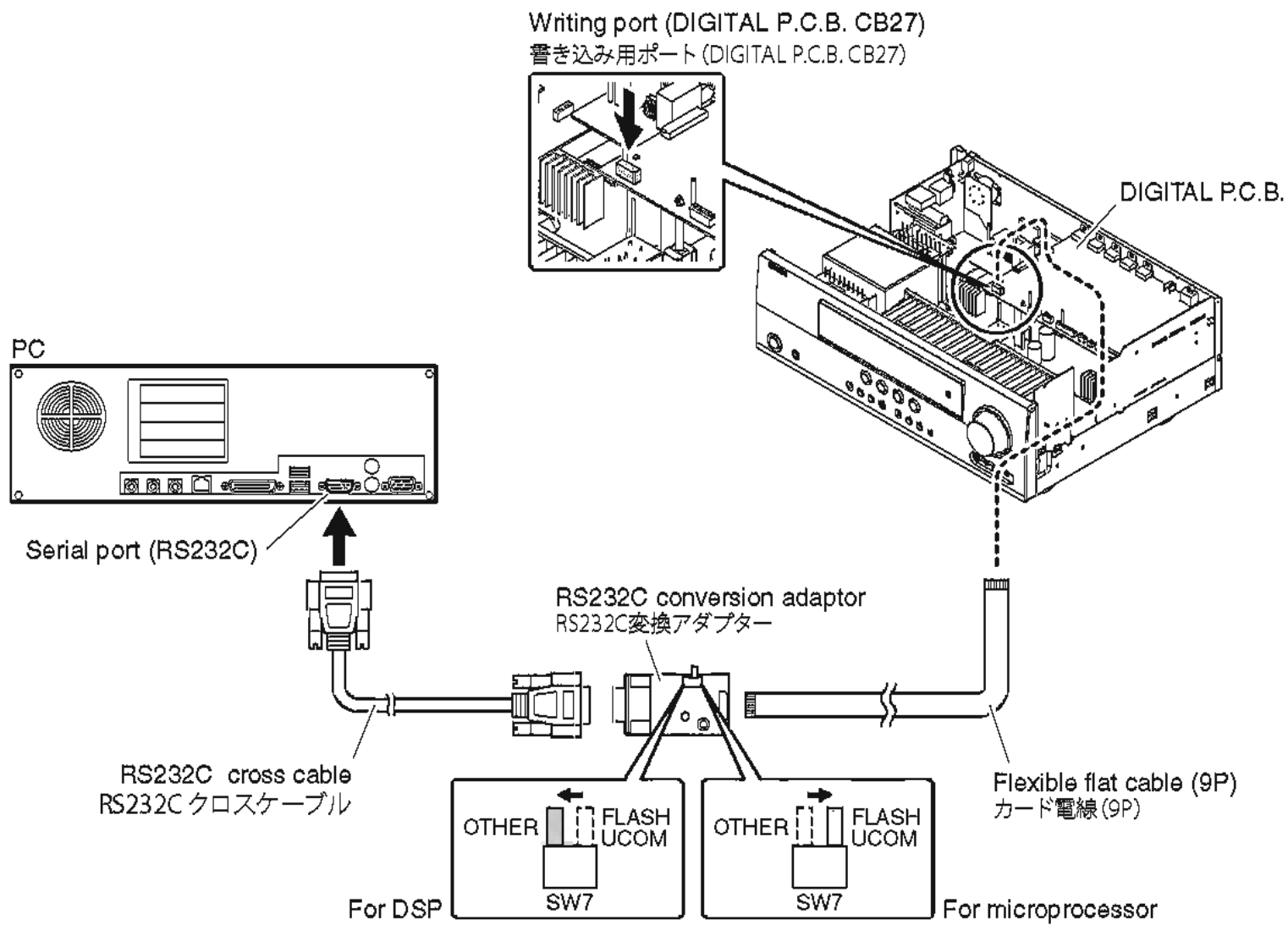

Fig. 1

● Operation Procedures

Writing to the microprocessor

1. With the power cable of this unit unconnected to the AC outlet, start up DSP_FLASHER_v3.0.exe.
The screen appears as shown below. (Fig. 2)
2. Click [...] and select the firmware name. (Fig. 2)

● 操作手順

マイコンへの書き込み

1. 本機の電源コードを AC コンセントに接続していない状態で、DSP_FLASHER_v3.0.exe を起動します。
下記の画面が表示されます。(Fig. 2)
2. [...] をクリックし、書き込むファームウェアを選択します。(Fig. 2)

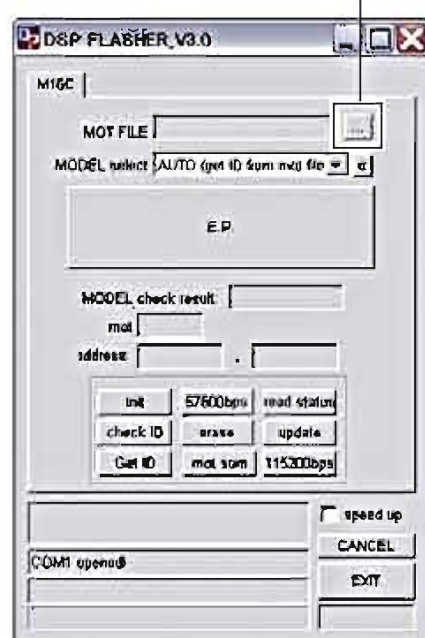

Fig. 2

RX-V465/HTR-6240/
AX-V465

- | | |
|--|--|
| <p>3. Connect the power cable of this unit to the AC outlet.</p> <p>4. Click [E.P.] to start writing. (Fig. 3)</p> <p>5. When writing of the firmware is completed, "Program Finished!" is displayed. (Fig. 3)
Click [OK]. (Fig. 3)</p> <p>6. Click [EXIT] to end DSP_FLASHER_v3.0.exe. (Fig. 3)</p> | <p>3. 本機の電源コードを AC コンセントに接続します。</p> <p>4. [E.P.] をクリックして書き込みを開始します。(Fig. 3)</p> <p>5. ファームウェアの書き込みが完了すると、"Program Finished!" が表示されます。(Fig. 3)
[OK] をクリックします。(Fig. 3)</p> <p>6. [EXIT] をクリックして DSP_FLASHER_v3.0.exe を終了します。(Fig. 3)</p> |
|--|--|

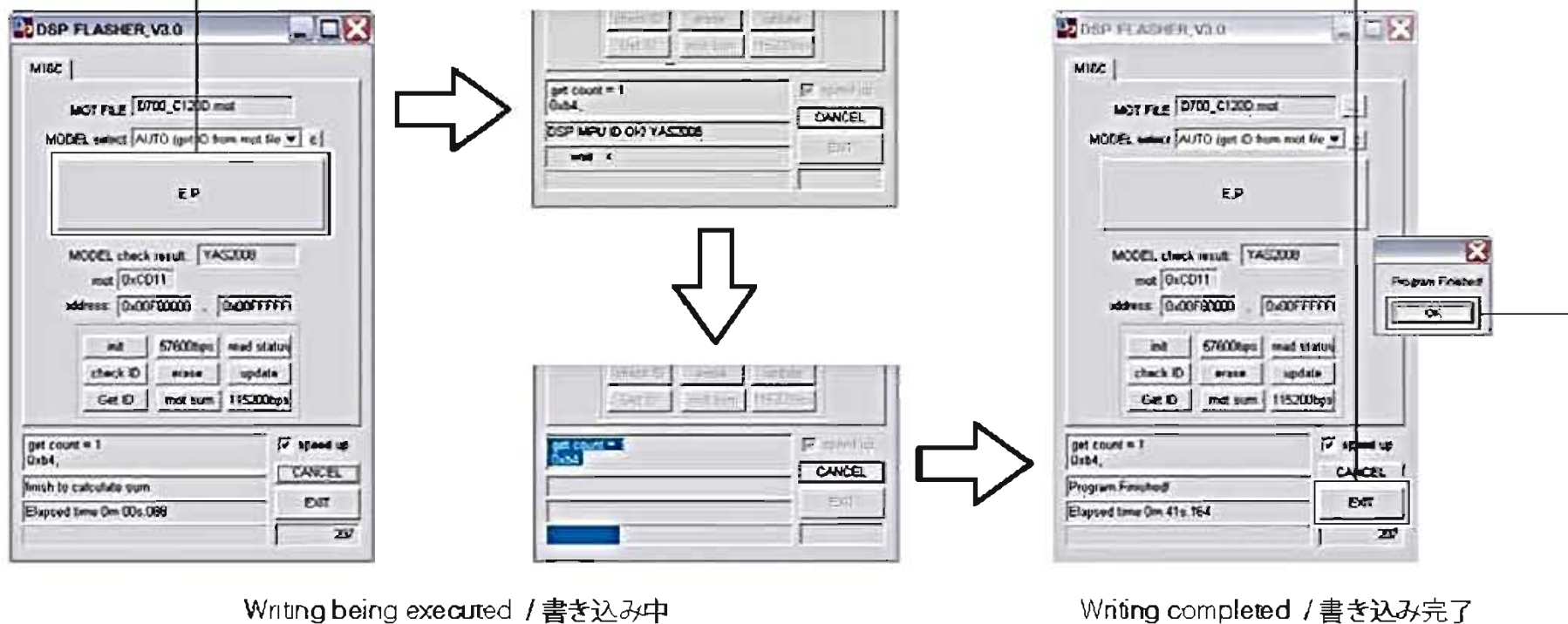

Fig. 3

- | | |
|--|--|
| <p>7. Start up the self-diagnostic function and select "25. ROM VER/SUM/PORT" menu.</p> <p>Using the sub-menu, have the firmware version and checksum displayed, and then check that they are the same as written ones.</p> <p>* When the firmware version and checksum are different from written ones, perform the "Writing to the microprocessor" all over again.</p> <p>8. Disconnect the power cable of this unit from the AC outlet.</p> | <p>7. ダイアグを起動し、"25. ROM VER/SUM/PORT"メニューを選択します。</p> <p>サブメニューでファームウェアのバージョンとチェックサムを表示し、それらが書き込んだものと同じであることを確認します。</p> <p>※ ファームウェアのバージョンとチェックサムが、書き込まれたものと異なる場合、"マイコンへの書き込み"をもう一度やり直してください。</p> <p>8. 本機の電源コードを AC コンセントから抜きます。</p> |
|--|--|

Writing to DSP

1. With the power cable of this unit unconnected to the AC outlet, start up DSP_FLASHER Ver2.7.exe.
The screen appears as shown below. (Fig. 4)
2. Click [Vx61 DSP]. (Fig. 4)

DSPへの書き込み

1. 本機の電源コードを AC コンセントに接続していない状態で、DSP_FLASHER Ver2.7.exe を起動します。
下記の画面が表示されます。(Fig. 4)
2. [Vx61 DSP] をクリックします。(Fig. 4)

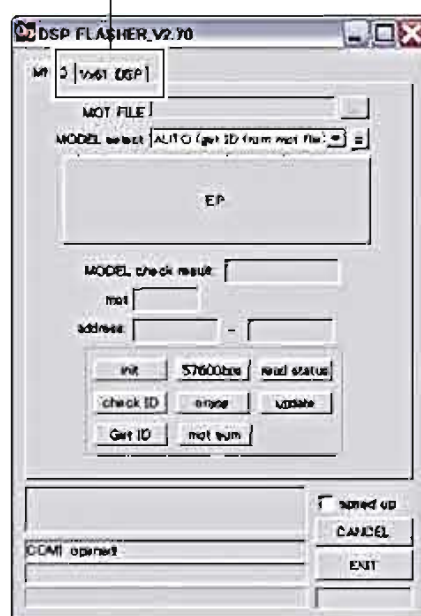

Fig. 4

3. Click [...] and select the firmware name. (Fig. 5)

3. [...] をクリックし、書き込むファームウェアを選択します。(Fig. 5)

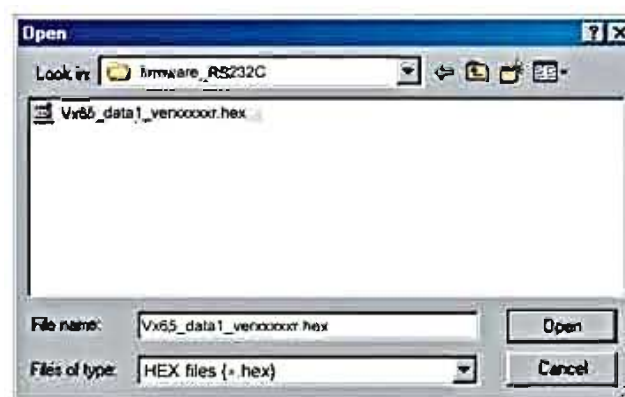
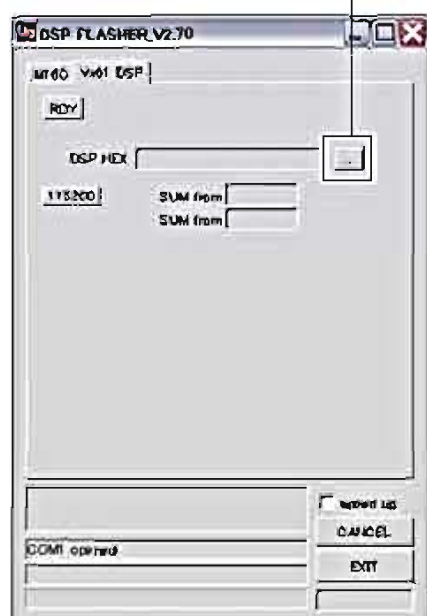

Fig. 5

RX-V465/HTR-6240/
AX-V465

4. Click [RDY]. (Fig. 6)

4. [RDY] をクリックします。(Fig. 6)

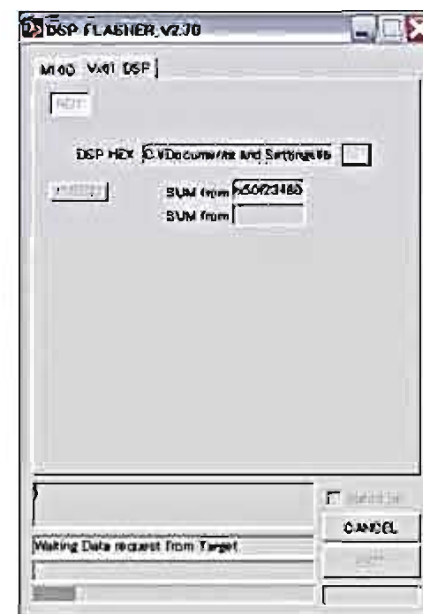
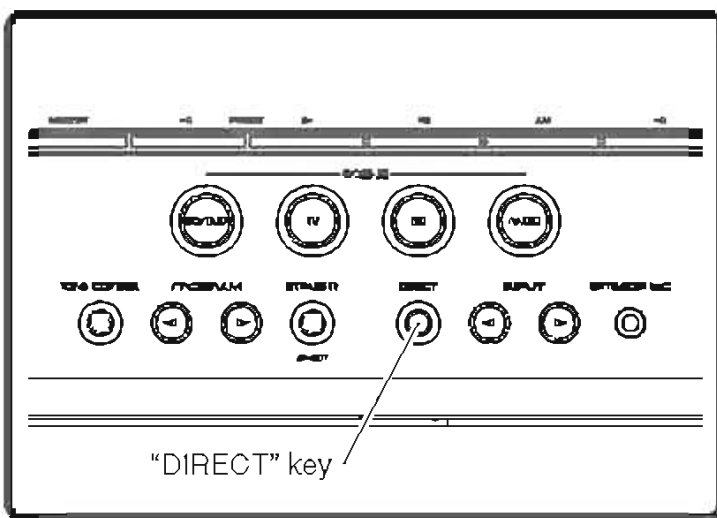

Fig. 6

5. While pressing the "DIRECT" key of this unit, connect the power cable of this unit to the AC outlet. (Fig. 7)
Writing is started automatically. (Fig. 7)

5. 本機の "DIRECT" キーを押しながら、本機の電源コードを AC コンセントに接続します。(Fig. 7)
自動的に書き込みを開始します。(Fig. 7)

This unit / 本機



Writing being executed /
書き込み中

Fig. 7

- | | |
|---|--|
| <p>6. When writing of the firmware is completed, "Vx61 DSP Flash finished!" is displayed. (Fig. 3)</p> <p>7. Click [EXIT] to end DSP_FLASHER_v2.7.exe. (Fig. 8)</p> | <p>6. ファームウェアの書き込みが完了すると、"Vx61 DSP Flash finished!" が表示されます。(Fig. 3)</p> <p>7. [EXIT] をクリックして DSP_FLASHER_v2.7.exe を終了します。(Fig. 8)</p> |
|---|--|



Fig. 8

- | | |
|---|---|
| <p>8. Start up the self-diagnostic function and select "25. ROM VER/SUM/PORT" menu.</p> <p>Using the sub-menu, have the firmware version and checksum displayed, and then check that they are the same as written ones.</p> <p>* When the firmware version and checksum are different from written ones, perform the "Writing to DSP" all over again.</p> <p>9. Disconnect the power cable of this unit from the AC outlet.</p> | <p>8. ダイアグを起動し、"25. ROM VER/SUM/PORT"メニューを選択します。</p> <p>サブメニューでファームウェアのバージョンとチェックサムを表示し、それらが書き込んだものと同じであることを確認します。</p> <p>※ ファームウェアのバージョンとチェックサムが、書き込まれたものと異なる場合、"DSP への書き込み" をもう一度やり直してください。</p> <p>9. 本機の電源コードを AC コンセントから抜きます。</p> |
|---|---|

RX-V465/HTR-6240/
AX-V465

■ SELF-DIAGNOSTIC FUNCTION / ダイアグ (自己診断機能)

This unit has self-diagnostic functions that are intended for inspection, measurement and location of faulty point.

There are 25 main menu items, each of which has sub-menu items.

Listed in the table below are main menu items and sub-menu items.

Note that not all menu items listed will apply to the models covered in this service manual.

本機には、検査、測定、不良個所の発見を目的にしたダイアグ (自己診断機能) があります。

メインメニューは25個あり、そのそれぞれにサブメニューがあります。

下表はダイアグメニュー一覧です。

下表の全ダイアグメニュー項目が、このサービスマニュアル記載のモデルに適用されるとは限りません。

No.	Main menu	Sub-menu
1	BYPASS	1 ANALOG BYPASS
		2 DSP BYPASS
2	RAM THROUGH	1 RAM MARGIN
		2 RAM FULL ALL
		3 RAM FULL CENTER
		4 RAM FULL SURROUND
		5 RAM FULL SURROUND BACK
3	HDMI AUDIO	1 SPDIF
		2 Multi
		3 DSD
4	SPEAKERS SET	1 FRNT: SML 0dB
		2 CENTER: NONE
		3 LFE/B: FRNT
		4 Zone2 Amp ON (Not applied to these models. / このモデルには適用されません。)
		5 BI-AMP (Not applied to these models. / このモデルには適用されません。)
		6 TONE: MAX
		7 TONE: MIN
		8 SPEAKER 6 ohms
5	MULTI CH-INPUT	1 8ch INPUT 6 ohms (Not applied to these models. / このモデルには適用されません。)
		2 8ch INPUT 8 ohms (Not applied to these models. / このモデルには適用されません。)
		3 LIM/PLDET/THM
6	MIC CHECK	1 MIC CHECK
7	FL CHECK	1 VFD CHECK
		2 VFD DISP OFF
		3 VFD DISP ALL
		4 VFD DIMMER
		5 CHECK PATTERN
8	MANUAL TEST	1 TEST ALL

No.	Main menu	Sub-menu
9	A/D DATA CHECK	1 PS1/PS2
		2 DC/TH
		3 IMP/PL
		4 DST/DK
		5 K0/K1
10	VIDEO CHECK	1 I2C
		2 DIGITAL COMPONENT
		3 DIGITAL CVBS
		4 DIGITAL Y/C (B, G, E, F models)
		5 ANALOG BYPASS
		6 TEST PATTERN (Not applied to these models. / このモデルには適用されません。)
		7 VIDEO INFORMATION
11	XM STATUS (Not applied to these models. / このモデルには適用されません。)	1 1k -1dB /44kHz
		2 1k -61dB /44kHz
		3 Mute /44kHz
		4 XM Tone /44kHz
		5 ISO Tone /44kHz
		6 1k -1dB /32kHz
		7 1k -61dB /32kHz
		8 Mute /32kHz
		9 XM Tone /32 kHz
		10 ISO Tone /32 kHz
		11 Bus Power: OFF
12	SIRIUS (Not applied to these models. / このモデルには適用されません。)	1 SIRIUS: OK (NG)
		2 SR
		3 SSP (SIRIUS #0 VERSION)
		4 MAC (SIRIUS #1 VERSION)
		5 ADP (SIRIUS #2 VERSION)
		6 PRDID
		7 SEQID
13	HD RADIO (Not applied to these models. / このモデルには適用されません。)	1 HD CPU VERSION
		2 D: xxxxxxxxxxxx
14	DOCK	1 DOCK
		2 BT VERSION
15	HDMI INFO	1 HMN
		2 HPI
		3 HVN

No.	Main menu	Sub-menu
16	HDMI SELECT	1 HDMI NONE
		2 HDMI IN 1
		3 HDMI IN 2
		4 HDMI IN 3
		5 HDMI IN 4
		6 HDMI UP CONVERSION
		7 HDMI UP THROUGH
17	USB (Not applied to these models. / このモデルには適用されません。)	1 USB File1
		2 USB File 2
18	IF STATUS (Not applied to these models. / このモデルには適用されません。)	1 DSP STATUS
19	BUS CHECK	1 TI BUS
		2 BF LOOP (Not applied to these models. / このモデルには適用されません。)
20	NO MENU	Invalidity
21	PROTECTION HISTORY	1 HISTORY 1
		2 HISTORY 2
		3 HISTORY 3
		4 HISTORY 4
22	NO MENU	Invalidity
23	UPDATE	1 TI FLASH BOOT (Not applied to these models. / このモデルには適用されません。)
24	FACTORY PRESET	1 PRESET INHI
		2 PRESET RSRV
25	ROM VER/SUM/PORT	1 VERSION
		2 ALL SUM
		3 TI (DSP) FLASH VERSION
		4 TI (DSP) FLASH SUM
		5 XM VERSION (Not applied to these models. / このモデルには適用されません。)
		6 SIRIUS VERSION (Not applied to these models. / このモデルには適用されません。)
		7 MODEL/DESTINATION
		8 Verify (Not applied to these models. / このモデルには適用されません。)

● Starting Self-Diagnostic Function

While pressing those 2 keys of this unit as shown in the figure below, press the "STANDBY/ON" key to turn on the power.

The self-diagnostic function mode is activated.

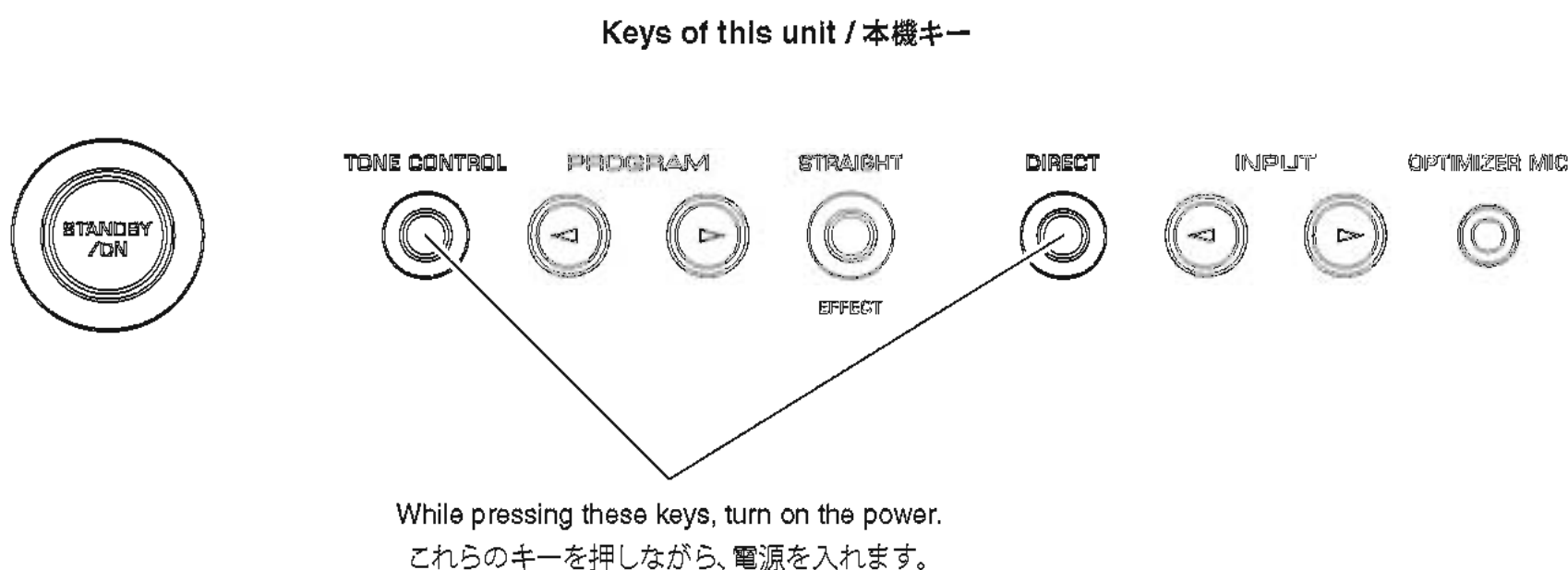

● Starting Self-Diagnostic Function in the protection cancel mode

If the protection function works and causes hindrance to trouble shoot, cancel the protection function as described below, and it will be possible to enter the self-diagnostic function mode.

(The protection functions other than the excess current detect function will be disabled.)

While pressing those 2 keys as shown in the figure above, press the "STANDBY/ON" key to turn on the power and keep pressing those 2 keys and "STANDBY/ON" key for 3 seconds or longer.

The self-diagnostic function mode is activated with the protection functions disabled.

In this mode, the SLEEP segment of the FL display of this unit flashes to indicate that the mode is self-diagnostic function mode with the protection functions disabled.

CAUTION!

Using this product with the protection function disabled may cause damage to itself. Use special care when using this mode.

● Canceling Self-Diagnostic Function

1. Before canceling self-diagnostic function, execute setting for FACTORY PRESET of main menu No. 24 (Memory Initialization Inhibited or Memory Initialized).
 - * In order to keep the user memory stored, be sure to select PRESET INHIBITED (Memory Initialization Inhibited).
2. Press the "STANDBY/ON" key of this unit to turn off the power.

● ダイアグの起動

本機の下図に示す2つのキーを押しながら "STANDBY/ON" キーを押して電源を入れます。

ダイアグが起動します。

● プロテクション解除モードでの起動

プロテクションが動作することにより、故障箇所の診断に支障をきたすような場合は、次の方法によりプロテクションを解除した状態でダイアグモードに入ることができます。

(過電流検出以外のプロテクション動作を解除する)

上図に示す2つのキーを押しながら "STANDBY/ON" キーを押して電源を入れ、2つのキーと "STANDBY/ON" キーを3秒以上押し続けます。

プロテクション解除モードでダイアグが起動します。

このモードでは本機FLの "SLEEP" セグメントが点滅し、プロテクションを解除した状態でのダイアグモードであることを知らせます。

注意!

プロテクションを解除した状態でのダイアグモードは、危険な状態でもプロテクションが作動しないため、動作させると、機器を破壊することがあります。このモードを使用する場合は十分注意してください。

● ダイアグの解除

1. ダイアグを解除する前に、メインメニュー No. 24 の FACTORY PRESET (メモリーの初期化禁止 / またはメモリーの初期化) の設定をします。
 - ※ ユーザーメモリーを保持したい場合は、必ず PRESET INHIBIT (メモリー初期化禁止) を選択してください。
2. 本機の "STANDBY/ON" キーを押して電源を切ります。

● **Display provided when Self-Diagnostic Function started**

The FL display of this unit displays the protection function history data then the main menu (sub-menu "1. ANALOG BYPAS" of main menu No. 1 BYPASS) a few seconds later.

When there is no history of protection function:

Opening message / オープニング表示

NO PROTECT

After a few seconds / 数秒後

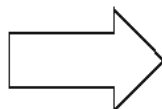

1. ANALOG BYPAS

プロテクション履歴がない場合:

Main menu display / メインメニュー表示

When there is a history of protection function:

When there is a history of protection function due to excess current
過電流によるプロテクション履歴がある場合

PRI PRT:xxx

AD value when the protection function is working/
電圧の A/D 変換値

プロテクション履歴がある場合:

Cause: An excessive current flowed through the power amplifier.

Supplementary Information: As current of the power amplifier is detected, the abnormal channel can be identified by checking the current detect transistor.

Turning on the power without correcting the abnormality will cause the protection function to work immediately and the power supply will instantly be shut off.

原因: パワーアンプに過電流が流れた。

補足: パワートランジスタの電流を検出していますので、電流検出トランジスタをチェックすれば異常チャンネルが特定できます。

異常状態のまま電源を入れると、瞬時にプロテクションが働き、すぐに電源が切れます。

Note)

- Applying the power to this unit without correcting the abnormality can be dangerous and cause additional circuit damage. To avoid this, if protection function has been activated 3 times continuously, the power will not turn on even when the "STANDBY/ON" key is pressed. In order to turn on the power again, disconnect the power cable of this unit from the AC outlet once and then reconnect it again.
- The output transistors in each amplifier channel should be checked for damage before applying power of this unit.
- Amplifier current should be monitored by measuring DC voltage across the emitter resistors for each channel.

注意!

- 異常状態のまま本機の電源を入れると、危険な状態になり、さらに回路が損傷を受ける原因になります。それを避けるために、プロテクションが連続して3回働いた場合、それ以降 "STANDBY ON/OFF" キーを押しても電源が入らなくなります。再度電源を入れる場合、一度本機の電源コードを AC 電源コンセントから抜いて接続し直してください。
- 本機の電源をいれる前に、各アンプのチャンネル内の出力トランジスタに損傷がないかチェックしてください。
- アンプの電流は、各チャンネルのエミッターの抵抗器間電圧を測定することによりモニターしてください。

When there is a history of protection function due to abnormal DC output
 DC出力異常によるプロテクション履歴がある場合

FRD PRT:xxx

AD value when the protection function is working/
 電圧の A/D 変換値

Cause: DC output from the power amplifier is abnormal.

Supplementary Information: The protection function worked due to a DC voltage appearing at the speaker terminal.

A cause could be a defect in the amplifier.

If the power is turned on with the abnormality unsolved, the protection function works in about 3 seconds to turn off the power.

原因: パワーアンプからの DC 出力が異常。

補足: パワーアンプの不具合により、スピーカー端子に直流電圧が加えられたために、プロテクションが働いたことを示します。

異常状態のまま電源を入れると、3 秒後にプロテクションが働き、電源が切れます。

When there is a history of protection function due to abnormal voltage in the power supply section
 電源部の電圧異常によるプロテクション履歴がある場合

FRU PRT:xxx

AD value when the protection function is working/
 電圧の A/D 変換値

Cause: The voltage in the power supply section is abnormal.

Supplementary Information: The protection function worked due to a defect or overload in the power supply.

If the power is turned on with the abnormality unsolved, the protection function works in about 1 second to turn off the power.

原因: 電源部の電圧が異常。

補足: 電源部の不具合により、電源電圧が正常な範囲から外れたために、プロテクションが働いたことを示します。

異常状態のまま電源を入れると、1 秒後にプロテクションが働き、電源が切れます。

When there is a history of protection function due to excessive heat sink temperature
ヒートシンクの異常温度によるプロテクション履歴がある場合

THM PRT:xxx

AD value when the protection function is working/
電圧の A/D 変換値

Cause: The temperature on the heat sink is excessive.

Supplementary Information: The protection function worked due to the temperature limit being exceeded. Causes could be poor ventilation or a defect related to the thermal sensor.

If the power is turned on with the abnormality unsolved, the protection function works in about 1 second to turn off the power.

* For detection of each protection function, refer to main menu described later.

原因: ヒートシンクの温度が異常。

補足: ヒートシンクの温度が制限値を超えたために、プロテクションが働いたことを示します。

異常状態のまま電源を入れると、1秒後にプロテクションが働き、電源が切れます。

※ 各プロテクションの検出に関しては、後述のメインメニューを参照してください。

● History of protection function

When the protection function has worked, its history is stored in memory with a backup.

Even if no abnormality is noted while servicing the unit, an abnormality which has occurred previously can be defined as long as the backup data has been stored.

The history of the protection function is cleared when self-diagnostic function is cancelled by selecting PRESET RESERVED (Memory initialized) of main menu No. 24 or when the backup data is erased.

● プロテクションの履歴

プロテクションが働いた場合、履歴をバックアップして記憶しています。サービスのときに異常が認められなくても、バックアップが残っていれば、お客様のところで起きた異常を区別できます。

メインメニュー No. 24 PRESET RESERVED (メモリーの初期化)を選んでダイアグを解除した場合、またはバックアップが消えた場合にプロテクションの履歴はクリアされます。

● Operation procedure of Main menu and Sub-menu

There are 25 main menu items, each of them having sub-menu items.

Main menu selection

Select the main menu using "SCENE TV" (forward) and "SCENE BD/DVD" (reverse) keys.

Sub-menu selection

Select the sub-menu using "SCENE RADIO" (forward) and "SCENE CD" (reverse) keys.

● メインメニューとサブメニューの操作

ダイアグにはNo. 1～25のメインメニューがあり、それぞれにサブメニューがあります。

メインメニューの選択

"SCENE TV" (順送り)、"SCENE BD/DVD" (逆送り) キーで選択します。

サブメニューの選択

"SCENE RADIO" (順送り)、"SCENE CD" (逆送り) キーで選択します。

Keys of this unit / 本機キー

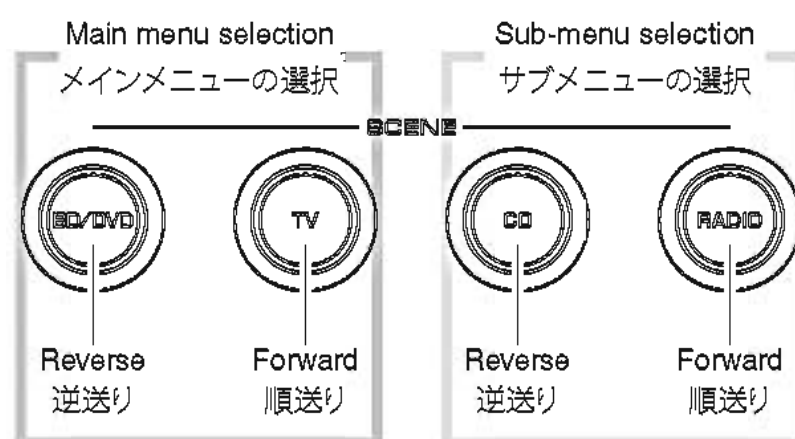

● Functions in Self-Diagnostic Function mode

In addition to the self-diagnostic function menu items, functions as listed below are available.

- Power ON/OFF
- Master volume
- Muting
- Input select
- Audio select
- PROGRAM select
- Tone control
- DIRECT ON/OFF

* Functions related to the tuner and the set menu are not available.

● Initial settings used to start Self-Diagnostic Function

The following initial settings are used when starting self-diagnostic function.

When self-diagnostic function is canceled, these settings are restored to those before starting self-diagnostic function.

- Master volume : -20 dB
- Input : AV5
- Main menu : 1. ANALOG BYPASS
- Speaker setting : LARGE, Bass out to SWFR (All channels)
- Speaker impedance : 8 ohms position

● ダイアグ中の機能

ダイアグメニューの他に、以下の機能が動作します。

- 電源 オン/オフ
- マスターボリューム
- ミューティング
- インプットセレクト
- オーディオセレクト
- プログラムセレクト
- トーンコントロール
- DIRECT ON/OFF

※ チューナー関連、セットメニュー関連は機能しません。

● ダイアグ開始時の初期設定

ダイアグ開始時に以下のような設定になります。

ダイアグ解除時にはダイアグ開始前の状態に戻ります。

- マスターボリューム : -20 dB
- インプット : AV5
- メインメニュー : 1. ANALOG BYPASS
- スピーカー設定 : LARGE、Bass out to SWFR (すべてのチャンネル)
- スピーカーインピーダンス : 8 オーム

● Details of Self-Diagnostic Function menu

1. BYPASS

Using the sub-menu, it is possible to select ANALOG BYPASS output or DSP BYPASS output.

ANALOG BYPASS

The analog input audio signal is output to FRONT L/R in DIRECT MODE.

● ダイアグメニュー詳細

1. BYPASS

サブメニューにより ANALOG BYPASS/DSP BYPASS が選択可能です。

ANALOG BYPASS

アナログ入力の音声信号が DIRECT MODE で FRONT L/R へ出力されます。

1. ANALOG BYPASS

INPUT: AV5 ANALOG
SPEAKER OUT: 1 kHz, PRE OUT (SUBWOOFER): 50 Hz

Input level	Volume	SPEAKER OUT			PRE OUT	
		FRONT L/R	CENTER	SURROUND L/R	SURROUND BACK L/R	SUBWOOFER
Both ch, -20 dBm	+6.5 dB	+15.0 dBm	-∞	-∞	-∞	-∞

DSP BYPASS

The digital input audio signal is output to FRONT L/R in DIRECT MODE.

DSP BYPASS

デジタル入力の音声信号が DIRECT MODE で FRONT L/R へ出力されます。

1. DSP BYPASS

INPUT: AV5 ANALOG
SPEAKER OUT: 1 kHz, PRE OUT (SUBWOOFER): 50 Hz

Input level	Volume	SPEAKER OUT			PRE OUT	
		FRONT L/R	CENTER	SURROUND L/R	SURROUND BACK L/R	SUBWOOFER
Both ch, -20 dBm	+6.5 dB	+15.0 dBm	-∞	-∞	-∞	-∞

ANALOG BYPASS

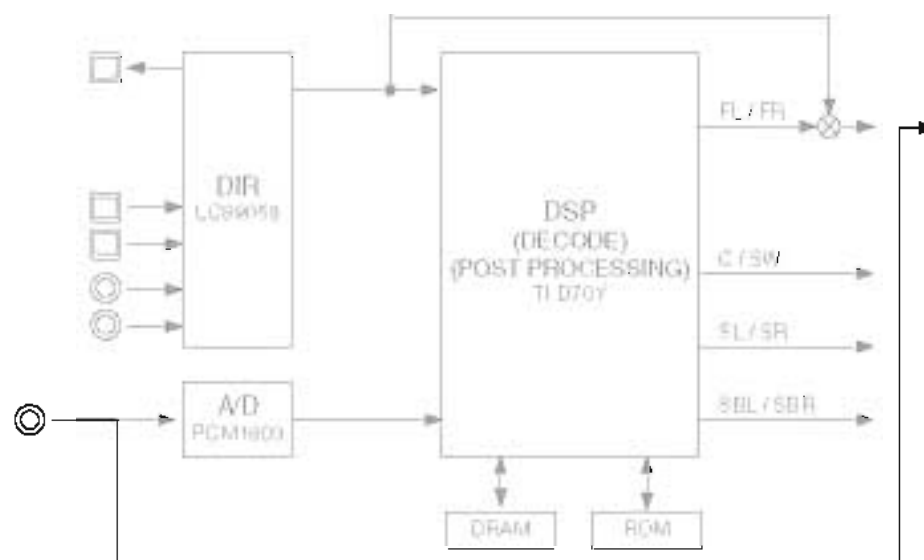

(Shaded items not used in this example)

DSP BYPASS

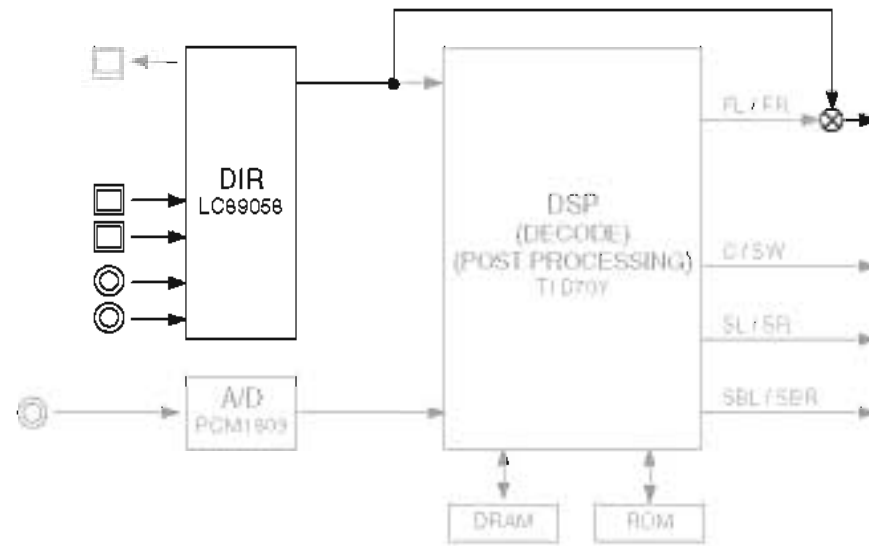

(Shaded items not used in this example)

2. RAM THROUGH

Using the sub-menu, it is possible to select MARGIN output or FULL BIT output.

RAM MARGIN

The audio signal is output including the head margin.

2. RAM THROUGH

サブメニューにより MARGIN/FULL BIT が選択可能です。

RAM MARGIN

音声信号がヘッドマージンを含んで出力されます。

2. RAM MARGIN

INPUT: AV5 ANALOG

SPEAKER OUT: 1 kHz, PRE OUT (SUBWOOFER): 50 Hz

Input level	Volume	SPEAKER OUT			PRE OUT	
		FRONT L/R	CENTER	SURROUND L/R	SURROUND BACK L/R	SUBWOOFER
Both ch, -20 dBm	+6.5 dB	+15.0 dBm	+15.0 dBm	+15.0 dBm	-16.0 dBm	-6.0 dBm

RAM FULL BIT

The audio signal is output in digital full bit without including the head margin.

The SUBWOOFER signal is output but not in digital full bit.

RAM FULL BIT

音声信号がヘッドマージンを含まず、デジタルフルビットで出力されます。

SUBWOOFERは出力されますが、デジタルフルビットではありません。

2. RAM FULL ALL

INPUT: AV5 ANALOG

SPEAKER OUT: 1 kHz, PRE OUT (SUBWOOFER): 50 Hz

Input level	Volume	SPEAKER OUT			PRE OUT	
		FRONT L/R	CENTER	SURROUND L/R	SURROUND BACK L/R	SUBWOOFER
Both ch, -20 dBm	+6.5 dB	+15.0 dBm	+15.0 dBm	+15.0 dBm	-16.0 dBm	-6.0 dBm

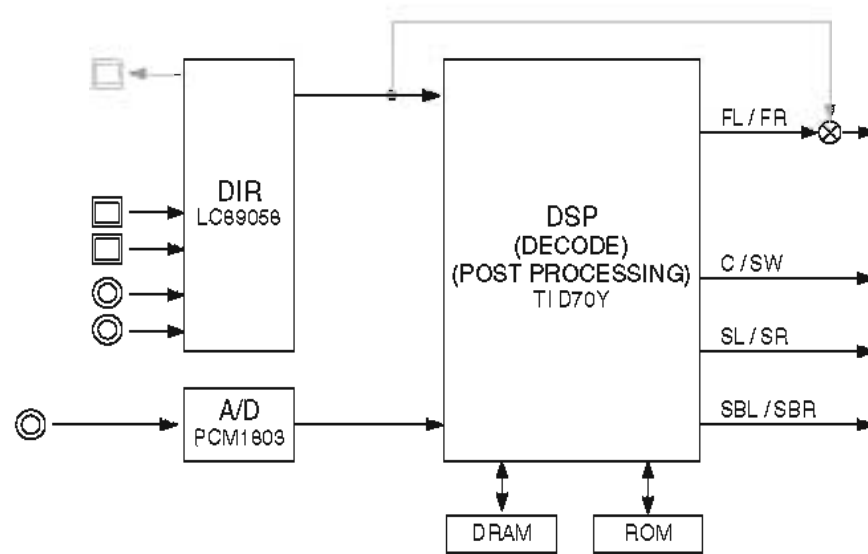

(Shaded items not used in this example)

When input source is stereo, signal is assigned as below.

2 ch 信号入力時、以下のように信号が振り分けられて出力されます。

- Front L → Front L / Center / Surround L / Surround Back L, R
- Front R → Front R / Surround R
- Front L +10 dB → SWFR

RAM FULL CENTER

The audio signal is output to only CENTER in digital full bit without including the head margin.

RAM FULL CENTER

音声信号がヘッドマージンを含まず、デジタルフルビットで CENTER のみへ出力されます。

2. RAM FULL C

INPUT: AV5 ANALOG

SPEAKER OUT: 1 kHz, PRE OUT (SUBWOOFER): 50 Hz

Input level	Volume	SPEAKER OUT			PRE OUT	
		FRONT L/R	CENTER	SURROUND L/R	SURROUND BACK L/R	SUBWOOFER
Both ch, -20 dBm	+6.5 dB	-∞	+15.0 dBm	-∞	-∞	-∞

RAM FULL SURROUND

The audio signal is output to only SURROUND L/R in digital full bit without including the head margin.

RAM FULL SURROUND

音声信号がヘッドマージンを含まず、デジタルフルビットで SURROUND L/R のみへ出力されます。

2. RAM FULL SUR

INPUT: AV5 ANALOG

SPEAKER OUT: 1 kHz, PRE OUT (SUBWOOFER): 50 Hz

Input level	Volume	SPEAKER OUT			PRE OUT	
		FRONT L/R	CENTER	SURROUND L/R	SURROUND BACK L/R	SUBWOOFER
Both ch, -20 dBm	+6.5 dB	-∞	-∞	+15.0 dBm	-∞	-∞

RAM FULL SURROUND BACK

The audio signal is output to only SURROUND BACK L/R in digital full bit without including the head margin.

RAM FULL SURROUND BACK

音声信号がヘッドマージンを含まず、デジタルフルビットで SURROUND BACK L/R のみへ出力されます。

2. RAM FULL SB

INPUT: AV5 ANALOG

SPEAKER OUT: 1 kHz, PRE OUT (SUBWOOFER): 50 Hz

Input level	Volume	SPEAKER OUT			PRE OUT	
		FRONT L/R	CENTER	SURROUND L/R	SURROUND BACK L/R	SUBWOOFER
Both ch, -20 dBm	+6.5 dB	-∞	-∞	-∞	-16.0 dBm	-∞

3. HDMI AUDIO

Using the sub-menu, the audio signals input to HDMI IN are selected and output.

- * When selecting "DSD", be sure to connect an HDMI unit equipped with DSD output function to this unit.

3. HDMI AUDIO

サブメニューにより、HDMI IN に入力された音声信号が選択、出力されます。

- ※ "DSD" を選択する場合、必ず DSD 出力が可能な HDMI 機器を接続してください。

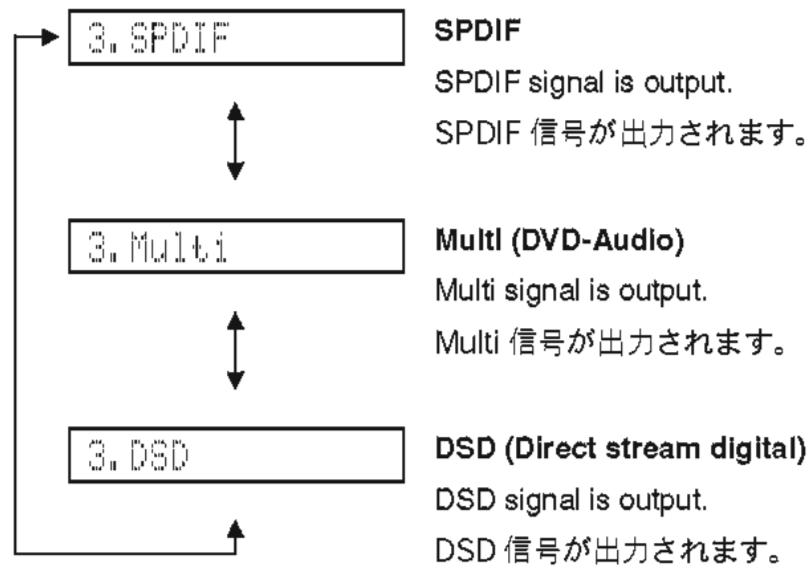

4. SPEAKER SET

The analog switch settings for each sub-menu are as shown in the table below.

	FRONT	CENTER	SURROUND	SUBWOOFER
FRNT : SML 0dB	SMALL	LARGE	LARGE	SWFR
CENTER : NONE	LARGE	NONE	LARGE	SWFR
LFE/B : FRNT	LARGE	SMALL	SMALL	FRONT
Zone2 Amp ON	—	—	—	—
Bi-AMP	—	—	—	—
TONE : MAX	LARGE	LARGE	LARGE	SWFR
TONE : MIN	LARGE	LARGE	LARGE	SWFR
SPEAKER 6 ohms	LARGE	LARGE	LARGE	SWFR

4. SPEAKER SET

各サブメニューにおけるアナログスイッチの設定は以下の通りです。

LARGE: This mode is used for a speaker with high bass reproduction performance (a large unit).
Full bandwidth signals are output.

SMALL: This mode is used for a speaker with low bass reproduction performance (a small unit).
The signals of 90 Hz or less are mixed into the channel specified by LFE/BASS.

NONE: This mode is used for no center speaker.
The center content is reduced by 3 dB and distributed to FRONT L/R.

SWFR: LFE of 5.1 ch signal or LFE/BASS lower than 90 Hz is output through SUBWOOFER OUT.

FRONT: LFE of 5.1 ch signal or LFE/BASS lower than 90 Hz is distributed to FRONT L/R.

LARGE : 低音再生能力の高い（ユニットの大きい）スピーカーを使用するモードです。
全帯域が出力されます。

SMALL : 低音再生能力の低い（ユニットの小さい）スピーカーを使用するモードです。
90 Hz 以下が LFE/BASS で指定したチャンネルへミックスされます。

NONE : センタースピーカーを使用しないモードです。
センター成分は -3 dB されて、FRONT L/R へ振り分けられます。

SWFR : 5.1 ch 信号の LFE または 90 Hz 以下の LFE/BASS が SUBWOOFER OUT へ出力されます。

FRONT : 5.1 ch 信号の LFE または 90 Hz 以下の LFE/BASS を FRONT L/R へ振り分けます。

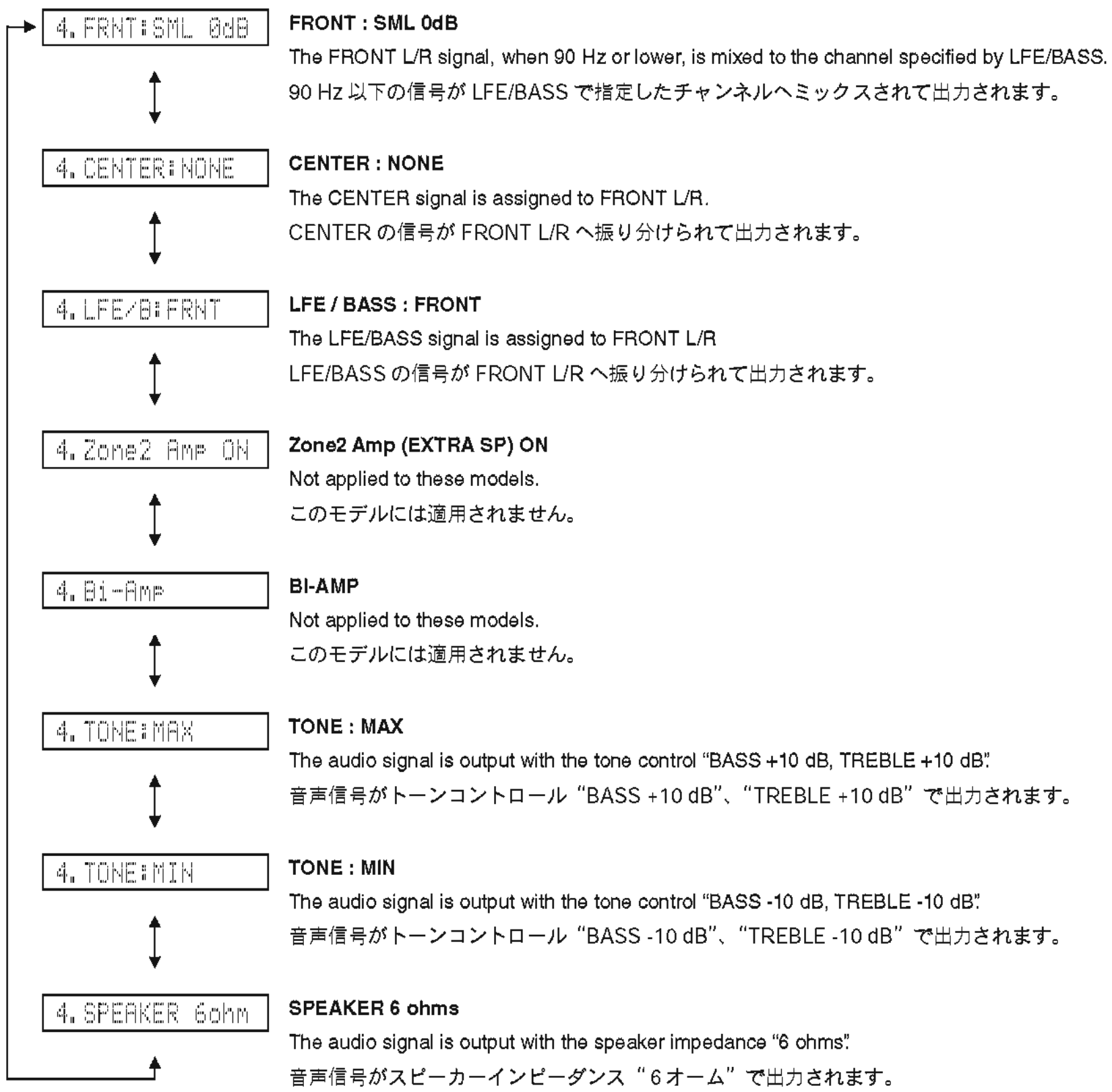

INPUT: AV5 ANALOG

SPEAKER OUT: 1 kHz, PRE OUT (SUBWOOFER): 50 Hz

Sub-menu	Input level	Volume	SPEAKER OUT			PRE OUT	
			FRONT L/R	CENTER	SURROUND L/R	SURROUND BACK L/R	SUBWOOFER
FRNT : SML 0dB	Both ch, -20 dBm	+6.5 dB	+15.0 dBm	+15.0 dBm	+15.0 dBm	-16.0 dBm	-4.0 dBm
CENTER : NONE	Both ch, -20 dBm	+6.5 dB	+20.0 dBm	-∞	+15.0 dBm	-16.0 dBm	-7.0 dBm
LFE/B : FRNT (50 Hz)	Both ch, -20 dBm	+6.5 dB	-∞	+15.0 dBm	+15.0 dBm	-16.0 dBm	-∞
Zone2 Amp ON	Both ch, -20 dBm	+6.5 dB	—	—	—	—	—
Bi-AMP	Both ch, -20 dBm	+6.5 dB	—	—	—	—	—
TONE : MAX	Both ch, -20 dBm	+6.5 dB	+16.0 dBm	+15.0 dBm	+15.0 dBm	-16.0 dBm	-7.0 dBm
TONE : MIN	Both ch, -20 dBm	+6.5 dB	+14.0 dBm	+15.0 dBm	+15.0 dBm	-16.0 dBm	-7.0 dBm
SPEAKER 6 ohms	Both ch, -20 dBm	+6.5 dB	+15.0 dBm	+15.0 dBm	+15.0 dBm	-16.0 dBm	-7.0 dBm

5. MULTI CH-INPUT

8 ch INPUT 6 ohms

Not applied to these models.

5.8ch INPUT_6Ω

8 ch INPUT 8 ohms

Not applied to these models.

5.8ch INPUT_8Ω

LIM / PLDET / THM

LIM: Setting value of LIM (Limiter control)

- * Do not change the value settings because this menu is only for the use of development staff.

PLDET: Power limiter detection

The A/D conversion value during operation is displayed.

(Reference voltage: 3.3 V=255)

THM: Temperature protection detection

The A/D conversion value during operation is displayed.

(Reference voltage: 3.3 V=255)

5. MULTI CH-INPUT

8 ch INPUT 6 ohms

このモデルには適用されません。

8 ch INPUT 8 ohms

このモデルには適用されません。

LIM / PLDET / THM

LIM : LIM (リミッター制御) の設定値

- ※ 開発スタッフ専用メニューですので、設定値の変更は行わないでください。

PLDET : パワーリミッターの検出

動作時の A/D 変換値が表示されます。

(基準電圧 : 3.3 V = 255)

THM : 温度プロテクションの検出

動作時の A/D 変換値が表示されます。

(基準電圧 : 3.3 V = 255)

255255117000...

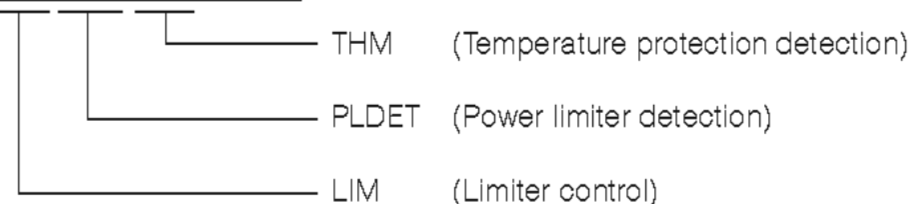

6. MIC CHECK

The signals input through the microphone are output to only FRONT L via A/D and D/A.

6.MIC CHK

6. MIC CHECK

マイクから入力された信号が A/D - D/A 経由で FRONT L のみへ出力されます。

7. FL CHECK

This menu is used to to check the FL display section.
Using the sub-menu, the FL display section vary as shown below.

7. FL CHECK

FL 表示部のチェックプログラムです。
サブメニューにより、FL 表示部の表示状態が以下のように変わります。

Checking FL display section / FL 表示部のチェック

Initial display / 初期表示

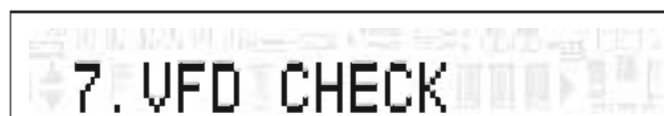

All segments OFF / 全セグメント消灯



All segments ON (dimmer 100 %) / 全セグメント点灯 (ディマー 100 %)



All segments ON (dimmer 50 %) / 全セグメント点灯 (ディマー 50 %)

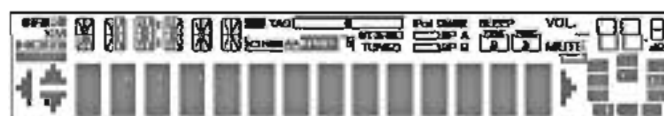

Lighting of segments in lattice / セグメント格子状点灯



Lighting in lattice / 格子状点灯

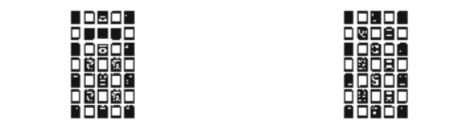

Short / ショート Normal / 正常

Segment conditions of the FL driver and the FL tube are checked by turning ON and OFF all segments. Next, the operation of the FL driver is checked by using the dimmer control. Then a short between segments next to each other is checked by turning ON and OFF all segments alternately (In lattice).

(In the above example, the segments in the second row from the top are shorted.)

全セグメント消灯・全セグメント点灯により FL ドライバー、FL 管のセグメントの不良を確認します。

次に、ディマーコントロールによって FL ドライバーの動作チェックを行います。

さらに全セグメントを交互（格子状）に点灯／消灯することで、隣り合うセグメントのショートをチェックします。

(上記の例は、上から 2 列目のセグメントがショートしています。)

RX-V465/HTR-6240/AX-V465

8. MANUAL TEST

The noise generator with a built-in DSP outputs the test noise through the channels specified by using the sub-menu.

The noise frequency for LFE is 30 to 80 Hz. Other than that, the noise frequency is 500 to 2 kHz.

TEST ALL

The test noise is output from all channels.

8. TEST ALL

9. A/D DATA CHECK

This menu is used to display the A/D conversion value of the microprocessor which detects panel keys of this unit and protection functions by using the sub-menu.

When K0/K1 menu is selected, keys become non-operable due to detection of the values of all keys.

In order to turn on the power again, disconnect the power cable of this unit from the AC outlet once and then reconnect it again.

* The figures in the diagram are given as reference only.

PS1/PS2

PSx: Power supply voltage protection detection

PS1

Voltage detects: AC_BL, AC_12, AC_5, ±12 and +5V

Normal value: 38 to 128
(Reference voltage: 3.3 V=255)

PS2

Voltage detects: -5 and +5V

Normal value: 31 to 125
(Reference voltage: 3.3 V=255)

* If PS1 and PS2 are out of the normal value range, the protection function works to turn off the power.

PS1:089 2:078

8. MANUAL TEST

DSP 内蔵のノイズ発生回路によって、サブメニューで指定したチャンネルへテストノイズが出力されます。

LFE 用のノイズ周波数は 30 ~ 80Hz、それ以外はノイズ周波数 500 ~ 2kHz となります。

TEST ALL

全チャンネルからテストノイズが出力されます。

9. A/D DATA CHECK

本機パネルキー、プロテクションなどを検出しているマイコンの A/D 変換値を、サブメニューで表示します。

K0/K1 のメニューにすると、全キーの値を検出するためキー操作はできなくなります。

再度電源を入れる場合、一度本機の電源コードを AC 電源コンセントから抜いて接続し直してください。

※ 図中の数値は参考例です。

PS1/PS2

PSx: 電源電圧プロテクションの検出

PS1

検出電圧: AC_BL、AC_12、AC_5、±12、+5V

正常値: 38 ~ 128
(基準電圧: 3.3 V = 255)

PS2

検出電圧: -5V、+5V

正常値: 31 ~ 125
(基準電圧: 3.3 V = 255)

※ PS1 および PS2 は正常値を外れるとプロテクションが働き、電源が切れます。

DC/TH

DC: Power amplifier DC (DC voltage) output is detected.
 Normal value: 23 to 70
 (Reference voltage: 3.3 V=255)

TH: Temperature on the heat sink is detected.
 Normal value: 0 to 124
 (Reference voltage: 3.3 V=255)

* If DC and TH are out of the normal value range, the protection function works to turn off the power.

DC:046 TH:111

DC/TH

DC: パワーアンプ DC (直流電圧) 出力の検出
 正常値: 23 ~ 70
 (基準電圧: 3.3 V = 255)

TH: ヒートシンク温度の検出
 正常値: 0 ~ 124
 (基準電圧: 3.3 V = 255)

※ DC および TH は正常値を外れるとプロテクションが働き、電源が切れます。

IMP/PL

IMP: 8 or 6 ohms impedance setup detection
 IMP 8: 8 ohm setting
 IMP 6: 6 ohm setting

PL: PLDET (Power amplifier output voltage detection)
 The power amplifier output voltage is detected and the power amplifier input voltage is controlled according to the detected output voltage.
 (Reference voltage: 3.3V=255)

IMP:8 PL:255

TH/PL

IMP: インピーダンス設定の検出
 (このモデルには適用されません。)

PL: PLDET (パワーアンプ出力電圧の検出)
 パワーアンプ出力電圧を検出して、パワーアンプ入力電圧を制御します。
 (基準電圧: 3.3 V = 255)

U, C, T, K, A, B, G, E, F models (Reference voltage: 3.3 V=255)

	During normal operation	Value for starting limiter operation	Value for canceling limiter operation
PLDET (8 ohms/6 ohms)	255 / 255	87 / 146	125 / 171
LIM (Limiter control)	H	L	H

R, L models (Reference voltage: 3.3 V=255)

	During normal operation	Value for starting limiter operation	Value for canceling limiter operation
PLDET (8 ohms/6 ohms)	255 / 255	100 / 100	131 / 131
LIM (Limiter control)	H	L	H

J model (基準電圧: 3.3 V = 255)

	通常値	リミッタ動作開始値	リミッタ動作解除値
PLDET (8 ohms/6 ohms)	255 / 255	100 / 100	131 / 131
LIM (リミッター制御)	H	L	H

DST/DK

DST: Destination detection
(Reference voltage: 3.3 V=255)

DK: DOCK type detection
(Reference voltage: 3.3 V=255)

DST/DK

DST: 仕向け先の検出
(基準電圧: 3.3 V = 255)

DK: DOCK タイプの検出
(基準電圧: 3.3 V = 255)

DST:027 DK:255

Destination detection for AD port
Pull-up resistance 10 k-ohms

Ohm (R3809 VIDEO P.C.B.)	0.0 k	1.2 k	2.7 k	4.7 k	6.8 k	10.0 k	15.0 k	47.0 k	100.0 k
A/D value (3.3 V=255)	0 - 15	15 - 46	46 - 69	69 - 92	92 - 115	115 - 139	139 - 177	185 - 224	224 - 247
DEST (139 pin)	J	U	C	R	T	K	A	B, G, E, F	L

DOCK detection for AD port (IC20 Microprocessor pin no. 128)
Pull-up resistance 10 k-ohms

DOCK type (DKID 141 pin)	Bluetooth	iPod	No connect
A/D value (3.3 V=255)	5 - 25	120 - 140	255

K0/K1

K0/K1: KEY0/KEY1 (Panel key of this unit)

When the A/D conversion value of the panel key becomes out of the specified range (standard value ± 4), normal operation will not be available.

In this case, check the constant of voltage dividing resistor, solder condition, etc. Refer to the table below.

(Reference voltage: 3.3 V=255)

K0/K1

K0/K1: KEY0/KEY1 (本機パネルキー)

パネルキーの A/D 値が規定範囲 (基準値 ± 4) から外れると、正常な動きをしません。

下表をご覧になり、各キーの分圧抵抗の定数、ハンダ不良等の確認をしてください。

(基準電圧: 3.3 V = 255)

K0:255 K1:255

Display / 表示	KEY0 (133 pin)
0 - 11	SCENE RADIO
12 - 32	SCENE CD
33 - 54	SCENE TV
55 - 75	SCENE BD/DVD
76 - 95	—
96 - 118	—
119 - 142	PROGRAM ▶
143 - 162	PROGRAM ◀
181 - 197	STANDBY/ON
198 - 229	TONE CONTROL
255	KEY OFF

Display / 表示	KEY1 (134 pin)
0 - 11	DIRECT
12 - 32	STRAIGHT
33 - 54	INFO
55 - 77	MEMORY
78 - 98	PRESET ◀
99 - 120	PRESET ▶
121 - 143	CATEGORY ◀ FM
144 - 165	CATEGORY ▶ AM
166 - 185	TUNING CH ◀
186 - 205	TUNING CH ▶
206 - 225	INPUT ◀
226 - 245	INPUT ▶
255	KEY OFF

10. VIDEO CHECK

I2C check

The I2C (Inter Integrated circuit) bus line connection is checked.

10. VIDEO CHECK

I2C check

I2C (Inter Integrated circuit) バスラインの接続をチェックします。

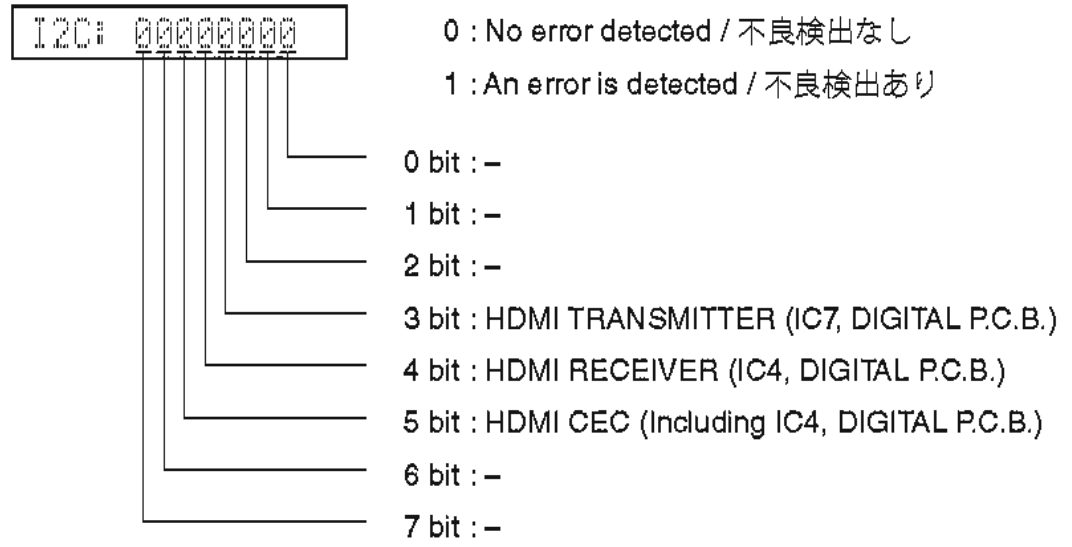

Digital component

The video signal is converted and output as shown below.

Digital component

映像信号が以下のように変換され、出力されます。

DIGITAL COMP

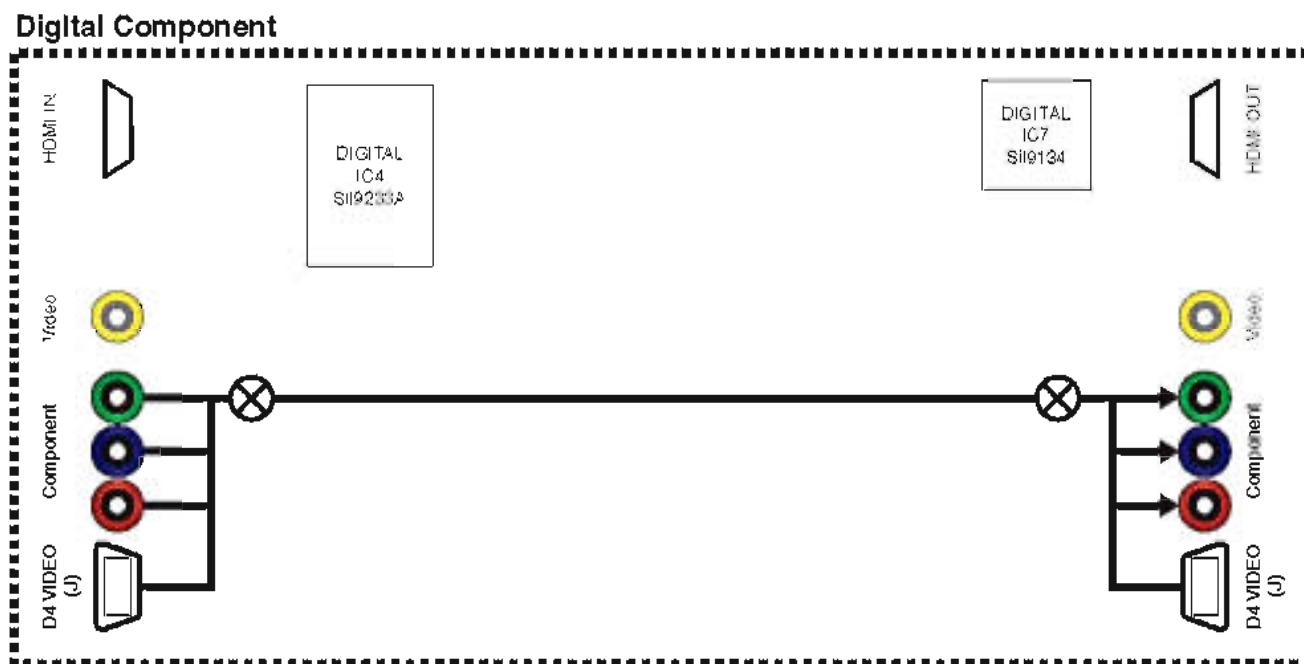

Digital CVBS (Video)

The video signal is converted and output as shown below.

Digital CVBS (Video)

映像信号が以下のように変換され、出力されます。

DIGITAL CVBS

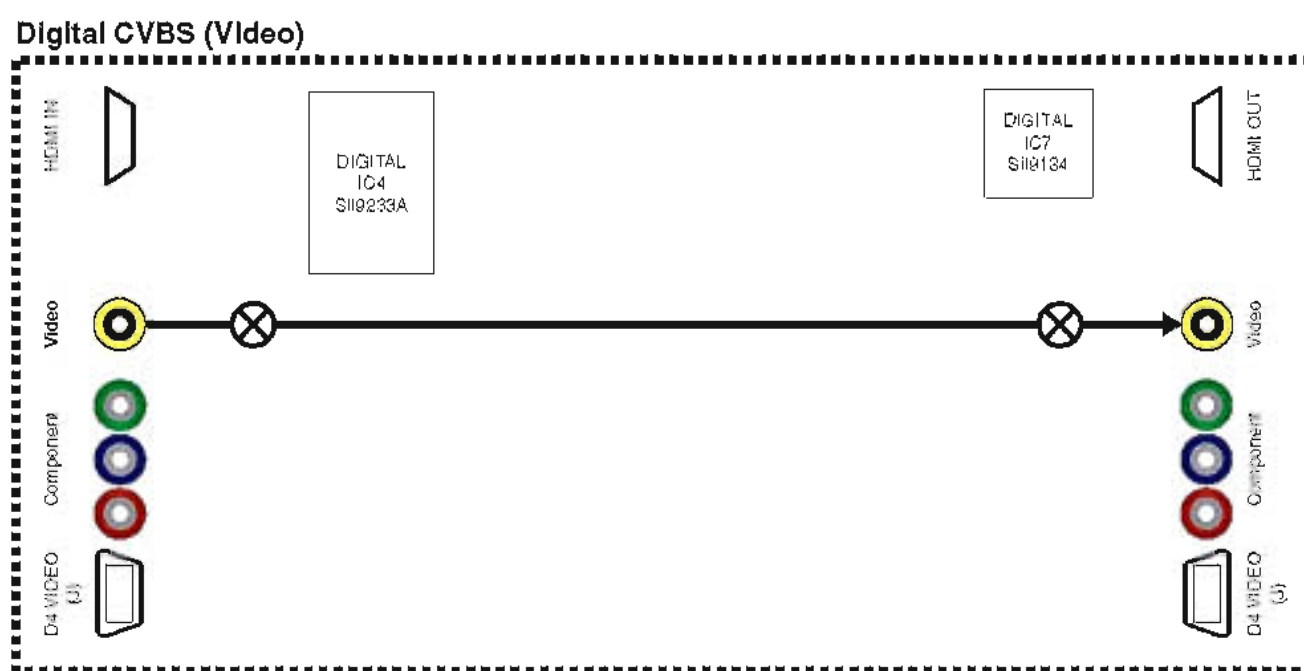

Digital Y/C (S-Video)

Not applied to these models.

Digital Y/C (S-Video)

このモデルには適用されません。

DIGITAL Y/C

RX-V465/HTR-6240/
AX-V465

Analog bypass

The video signal is converted and output as shown below.

Analog bypass

映像信号が以下のように変換され、出力されます。

ANALOG BYPASS

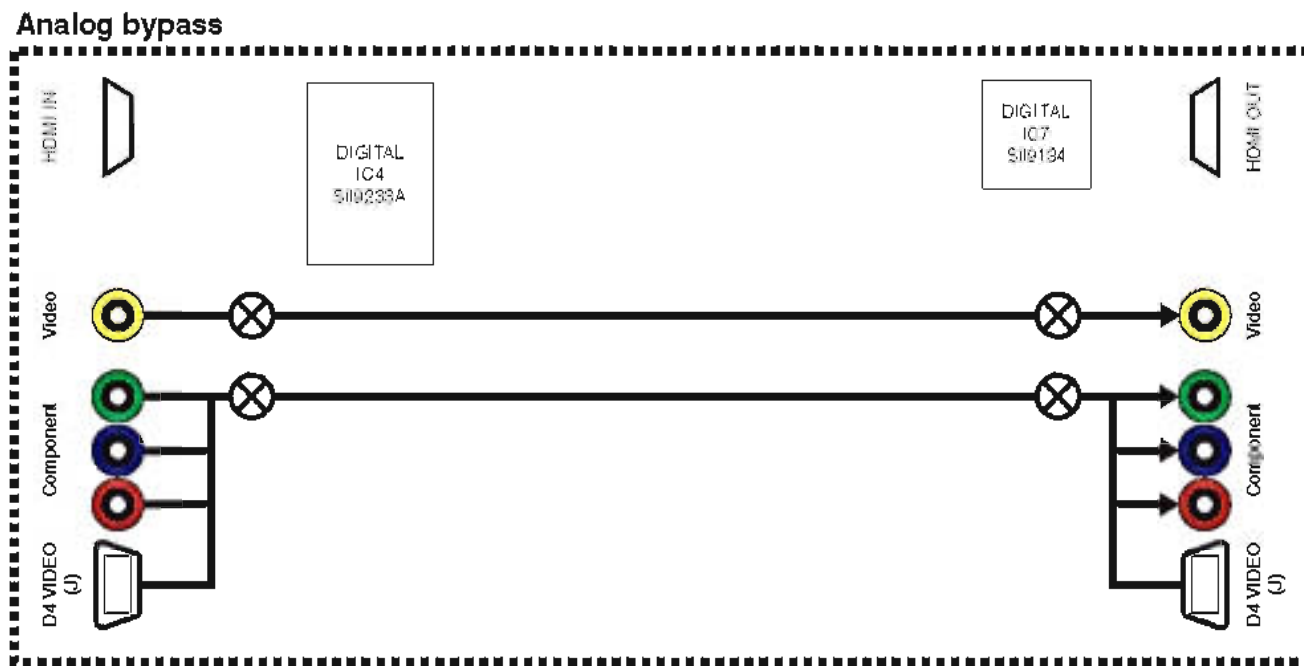

Test pattern

Not applied to these models.

Test pattern

このモデルには適用されません。

TEST PATTERN

Video Information

The information of input video signals is displayed.

Video information

入力されている映像信号の情報が表示されます。

Example / 例

VIDEO IN 480i

11. XM STATUS (U model)

Not applied to these models.

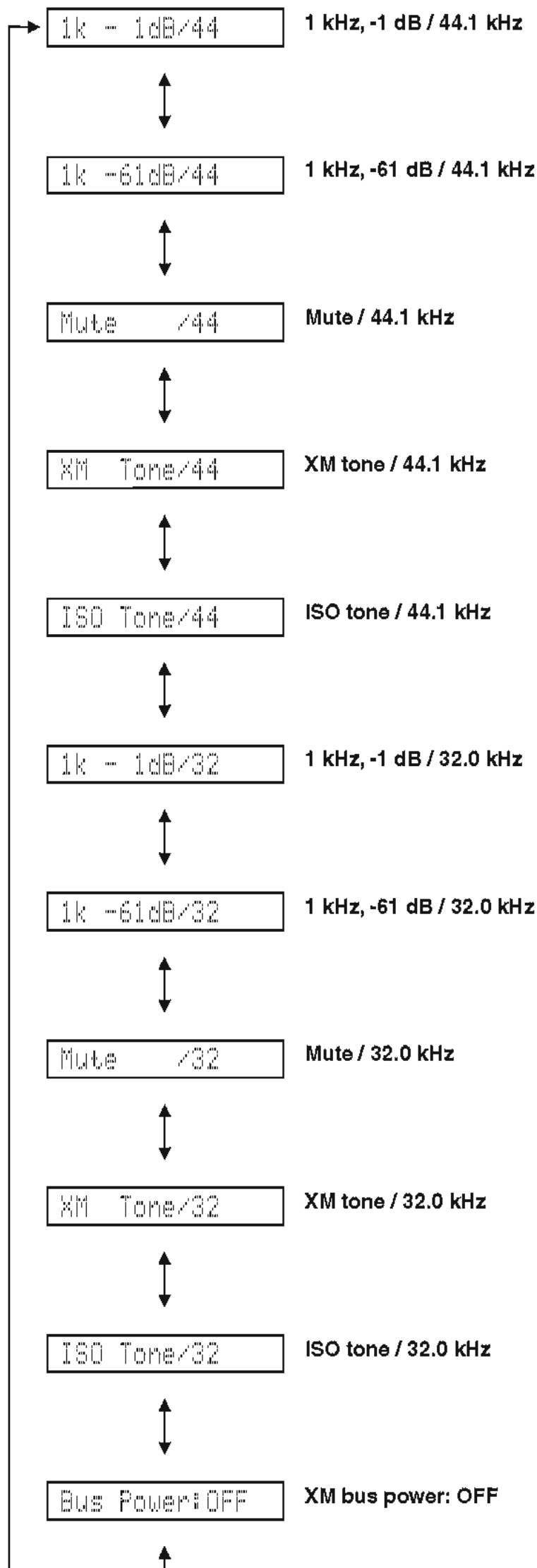

12. SIRIUS (U model)

Not applied to these models.

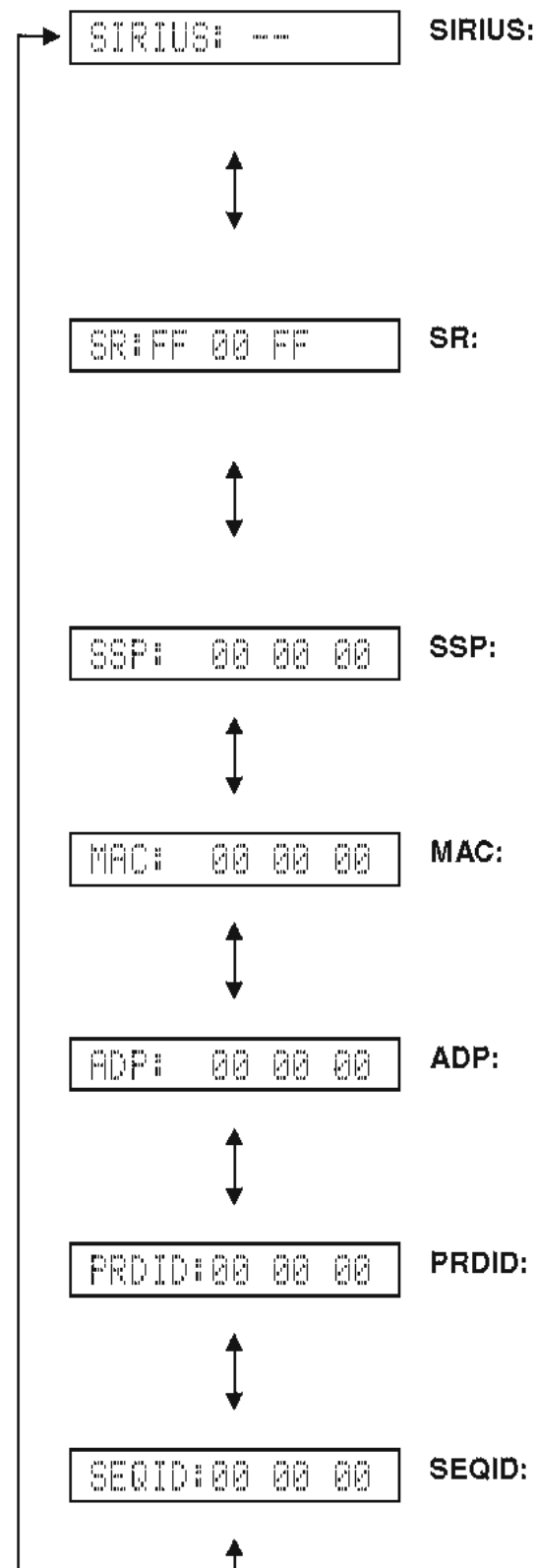

13. HD RADIO

Not applied to these models.

CPU version

HD CPU V:

DSP version

D:

14. DOCK

This menu is used to check the DOCK connector without the iPod itself.

With the power to this unit turned off, short between pins No. 14 (TX) and No. 18 (RX), between pins No. 1 (PWR) and No. 17 (ACCPOW), between pins No. 4 (IPDET) and No. 8 (DGND). Also, connect a 10 k-ohms, 1/4W resistor between pins NO. 21 (DKID) and No. 8 (DGND). (Make sure that the power is turned off when shorting pins.)

Start up the self-diagnostic function and select this menu.

The check result is displayed according to the following display specifications.

Note) Be sure to return the shorted pins to their original condition after executing this test.

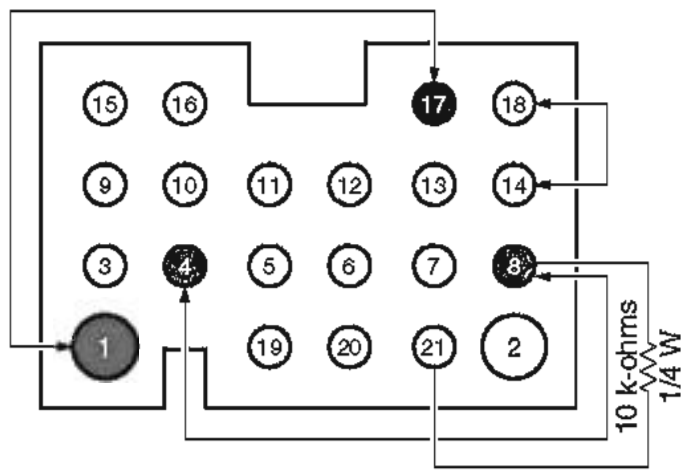

DOCK CONNECTOR

14. DOCK

iPod 本体無しで、DOCK コネクタの検査を行うメニューです。

本機の電源を切った状態で、DOCK コネクタの 14 ピン (TX) と 18 ピン (RX)、1 ピン (PWR) と 17 ピン (ACCPOW)、4 ピン (IPDET) と 8 ピン (DGND) をショートさせます。また、21 ピン (DKID) と 8 ピン (DGND) の間に 10 k Ω、1/4 W 抵抗を接続します。(ショートさせる時は、必ず電源を切ってください。)

ダイアグを起動して本メニューを選択します。

下記表示仕様に従って、チェック結果が表示されます。

注意) 検査後、ショートしたピンを必ず元の状態に戻してください。

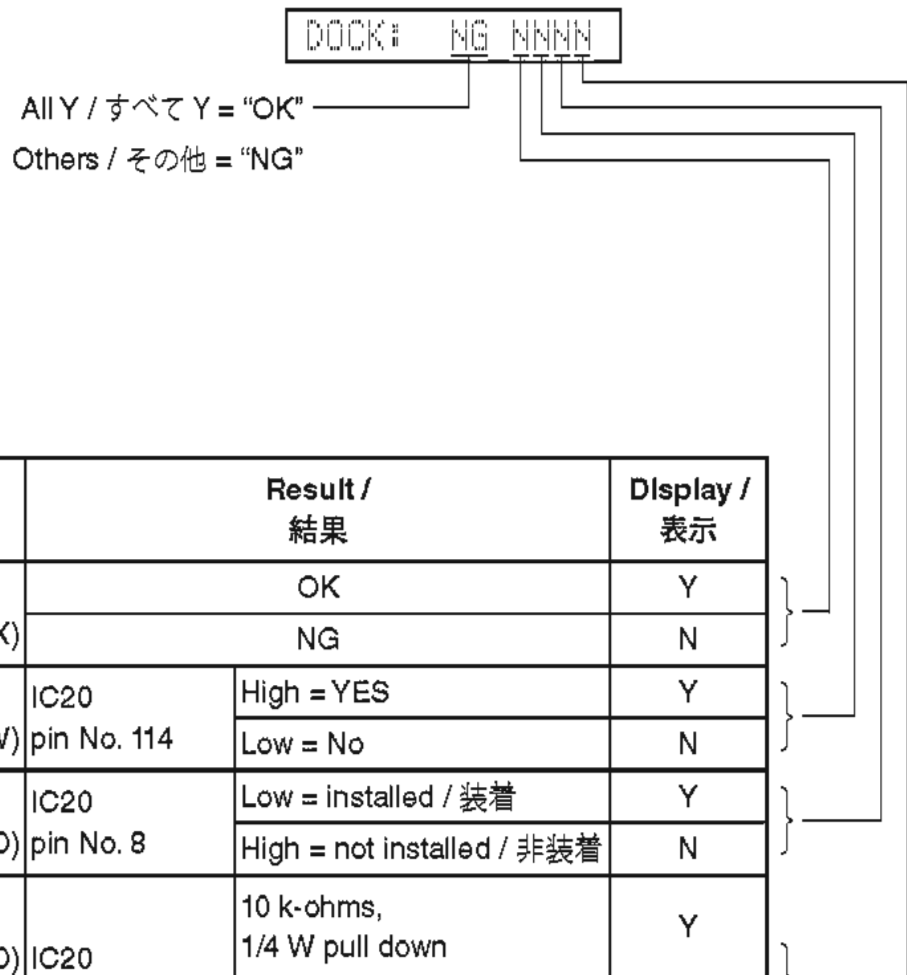

Check Item / チェック項目	Short pins / ショートピン	Result / 結果	Display / 表示
UART loop back test / UART ループバックテスト	Pins No.14 (TX) - No.18 (RX)	OK	Y
		NG	N
iPAP (iPod accessory power) detection / iPAP (iPod accessory power) 検出	Pins No.1 (PWR) - No.17 (ACCPOW)	IC20 pin No. 114 High = YES	Y
		Low = No	N
iPDET (iPod installation to DOCK) detection / iPDET (iPod Installation to DOCK) 検出	Pins No.4 (iPDET) - No.8 (DGND)	IC20 pin No. 8 Low = installed / 装着	Y
		High = not installed / 非装着	N
DKID (DOCK ID) detection / DKID (DOCK ID) 検出	Pins No.21 (DKID) - No.8 (DGND) * 10 k-ohms, 1/4 W pull down	IC20 pin No. 141 10 k-ohms, 1/4 W pull down	Y
		Other	N

BT VERSION

The DOCK (Bluetooth module) version is displayed.

BT VERSION

DOCK (Bluetooth module) のバージョンが表示されます。

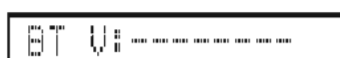

15. HDMI INFORMATION

The HDMI information are displayed.

15. HDMI INFORMATION

HDMI の情報が表示されます。

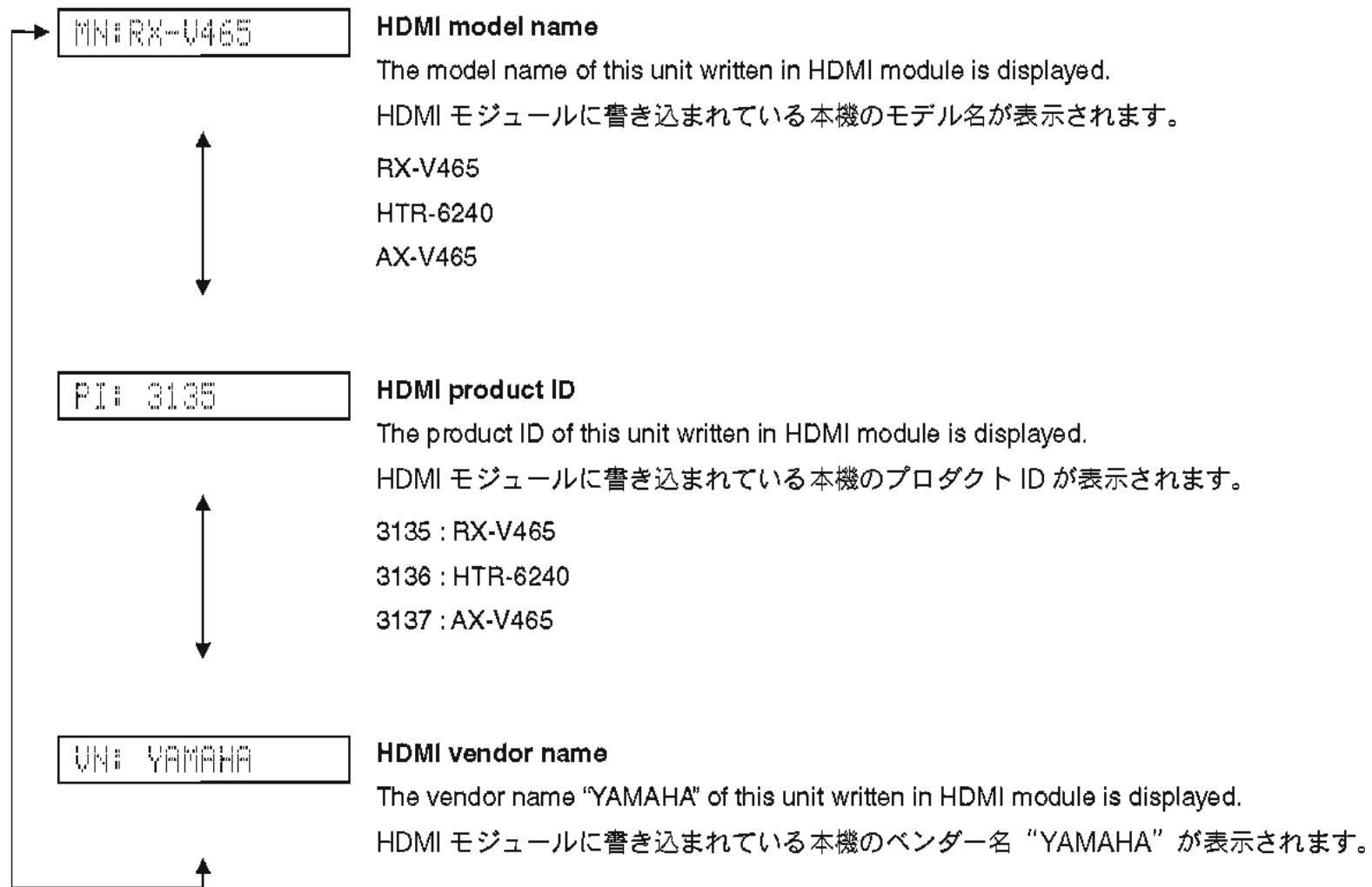

16. HDMI SELECT

Using the sub-menu, the selected input signal is output to HDMI OUT.

* Support audio is set to "OTHER".

16. HDMI SELECT

サブメニューにより、選択された入力信号がHDMI OUTへ出力されます。

※ SUPPORT AUDIOは"OTHER"に設定されます。

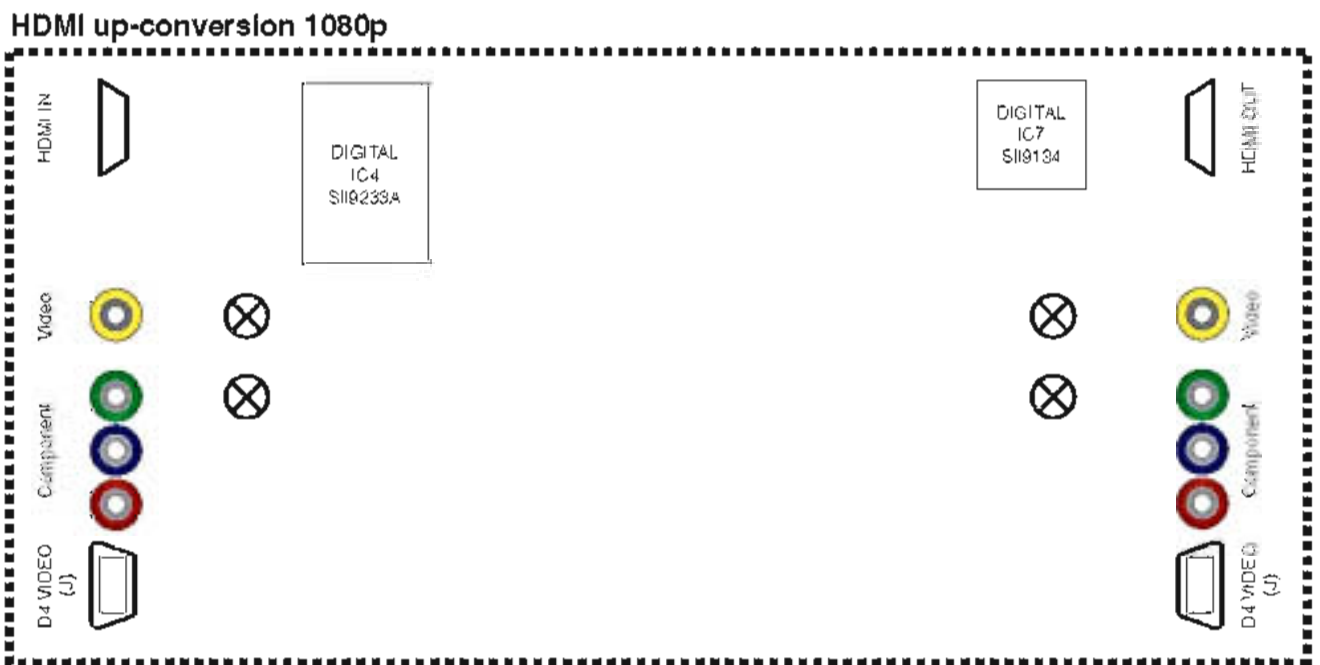
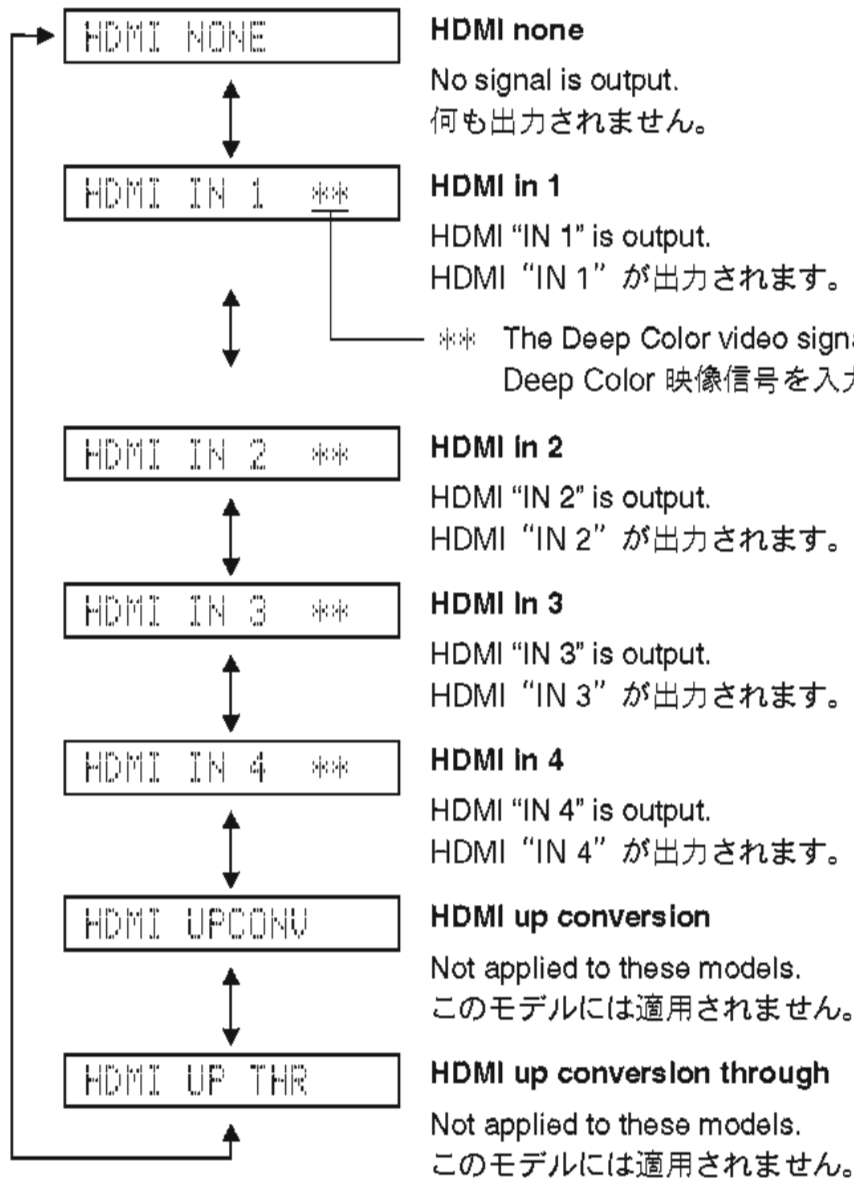

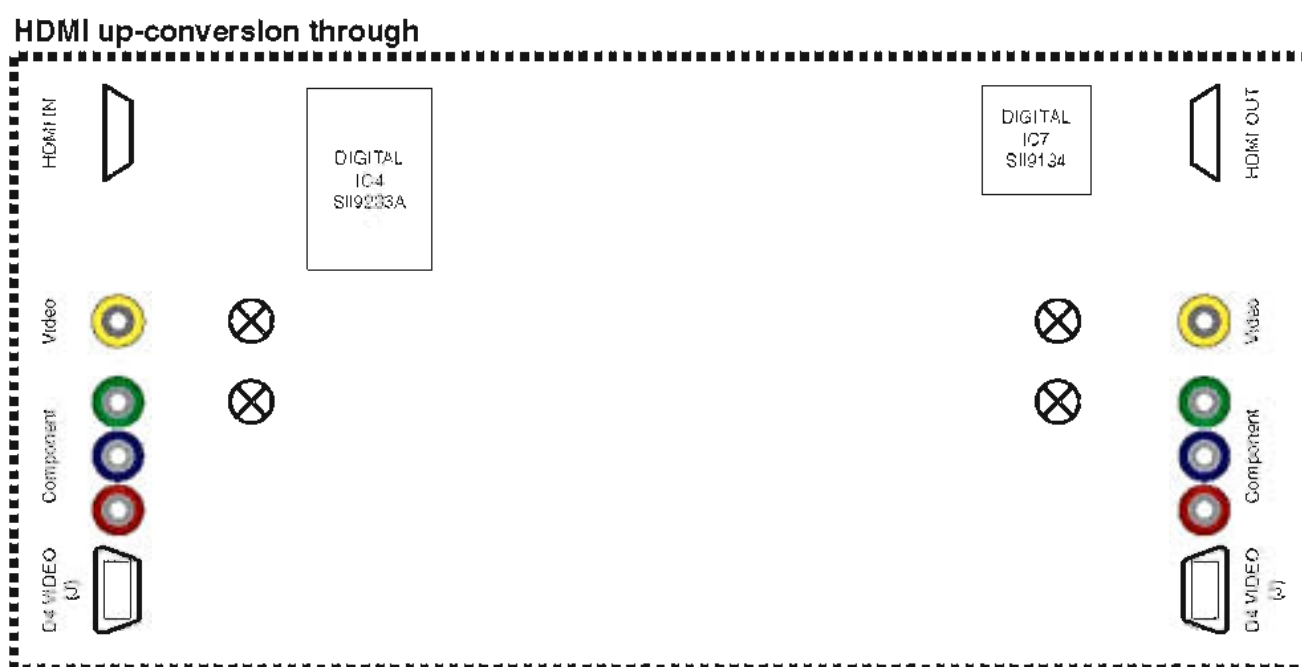

17. USB

Not applied to these models.

USB file 1

USB file 2

17. USB

このモデルには適用されません。

USB file 1

17:USB file 1

USB file 2

17:USB file 2

18. IF STATUS (Input function status)

Not applied to these models.

DSP status

DST: 7700020000

19. BUS CHECK

Communication and bus line connection between devices on the DSP P.C.B. are checked.

TI (DSP) BUS check

Communication and bus line connection between microprocessor (IC20) and TI (DSP, IC44) are checked.

TI BUS: NoEr

NoEr : No error detected.

Boot : When "Boot" is displayed for a few seconds or "Boot" and "NoEr" are displayed alternately, there is possibility that an error occurs.

BF LOOP :

Not applied to these models.

BF LOOP:

18. IF STATUS (Input function status)

このモデルには適用されません。

DSP status

19. BUS CHECK

DSP P.C.B. 内のデバイス間の通信とバスラインの接続をチェックします。

TI (DSP) BUS check

マイコン (IC20) と TI (DSP, IC44) の通信・バスラインの接続をチェックします。

NoEr : 不良検出なし

Boot : "Boot" が数秒間表示されるまたは "Boot" と "NoEr" が交互に表示される場合、異常が発生している可能性があります。

BF LOOP :

このモデルには適用されません。

RX-V465/HTR-6240/
AX-V465

20. NO MENU (Invalidity)

20. NO MENU (Invalidity)

Invalidity

21. PROTECTION HISTORY

The history of protection function is displayed.

Select this menu and press the "STRAIGHT" key, and the history will be erased.

21. PROTECTION HISTORY

過去のプロテクション履歴が表示されます。

サブメニューを選んだ後、"STRAIGHT" キーを押すと履歴は消去されます。

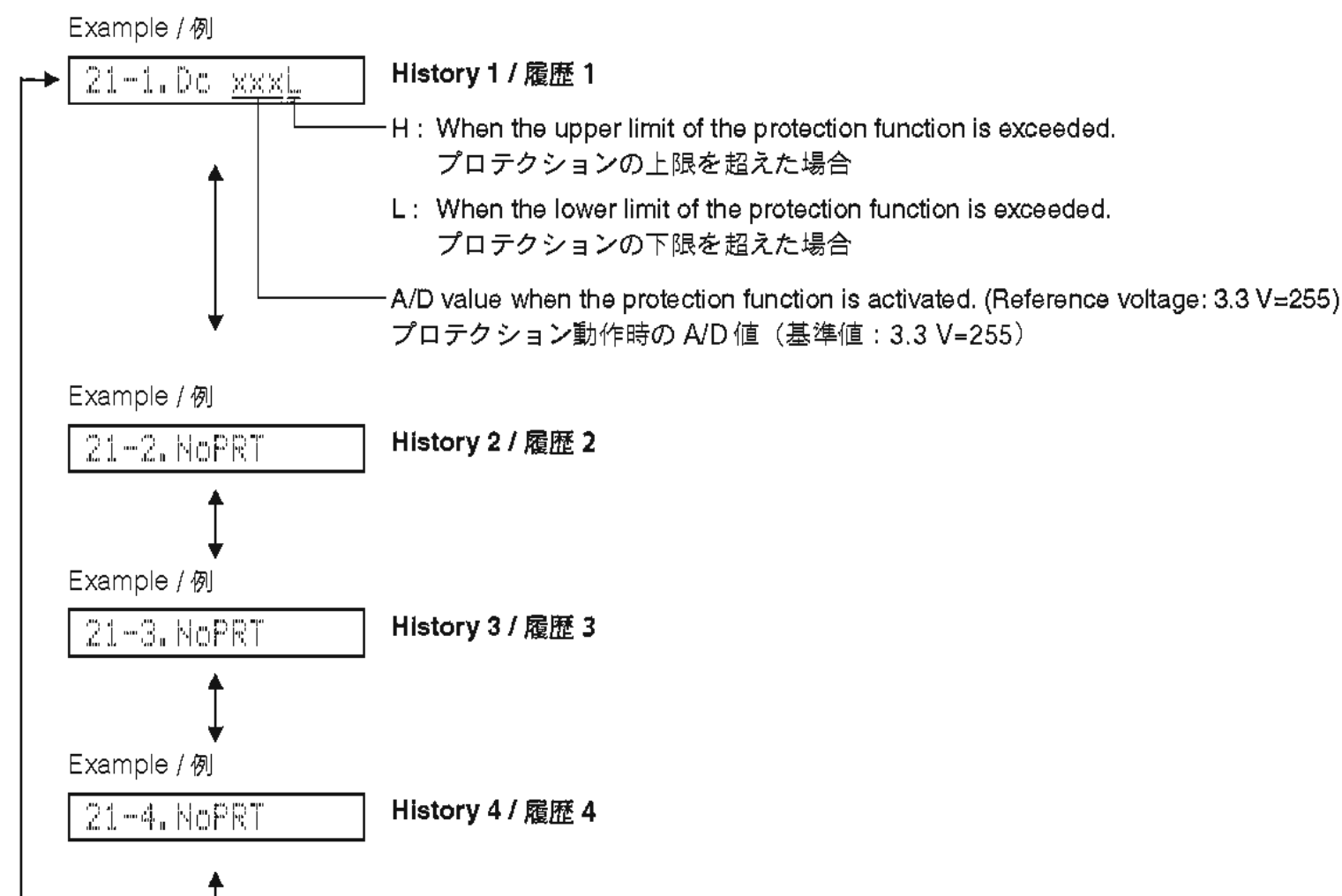

22. NO MENU (Invalidity)

22. NO MENU (Invalidity)

Invalidity

23. UPDATE

Not applied to these models.

23. UPDATE

このモデルには適用されません。

UPDATE TI

UPDATE TI

23. UPDATE TI

RX-V465/HTR-6240/AX-V465

24. FACTORY PRESET

This menu is used to reserve and inhibit initialization of the back-up IC.

24. PRESET INHI



24. PRESET RSRV

PRESET INHIBIT (Initialization inhibited) / PRESET INHIBIT (初期化禁止)

Back-up IC initialization is not executed. Select this sub-menu to protect the values set by the user.

バックアップICの初期化は行われません。ユーザーの設定値を保護するときは、こちらを選択してください。

PRESET RESERVED (Initialization reserved) / PRESET RESERVED (初期化予約)

Initialization of the back-up IC is reserved. (Actually, initialization is executed the next time that the power is turned on.) Select this sub-menu to reset to the original factory settings or to reset the back-up IC. Any protection history will be cleared.

バックアップICの初期化が予約されます。(実際に初期化されるのは、次回の電源投入時です。)工場出荷時やバックアップICをリセットしたいときは、こちらを選択してください。このとき、プロテクション履歴も初期化されます。

CAUTION: Before setting to the PRESET RESERVED, write down the existing preset memory content of the tuner.

(This is because setting to the PRESET RESERVED will cause the user memory content to be erased.)

24. FACTORY PRESET

バックアップ用IC（音場プログラムのパラメーターやセットメニュー内容等）の初期化を予約／禁止します。

注意： PRESET RESERVED を選んで初期化をする前に、チューナーのユーザーメモリー内容を書き写してください。

(初期化をすると、ユーザーメモリーの内容は消えてしまいます。)

25. ROM VER/SUM/PORT

The firmware version, checksum values, model name and destination are displayed.

The checksum is obtained by adding the data at every 8-bit for each program area and expressing the result as a 4-figure hexadecimal data.

* The figures in the diagram are given as reference only.

25. ROM VER/SUM/PORT

ファームウェアのバージョン、チェックサム、モデル名、仕向け先が表示されます。

チェックサムは、プログラムエリア別にデータを8ビットごとに加算していき、4桁の16進データで現したものです。

※ 図中の数値は参考例です。

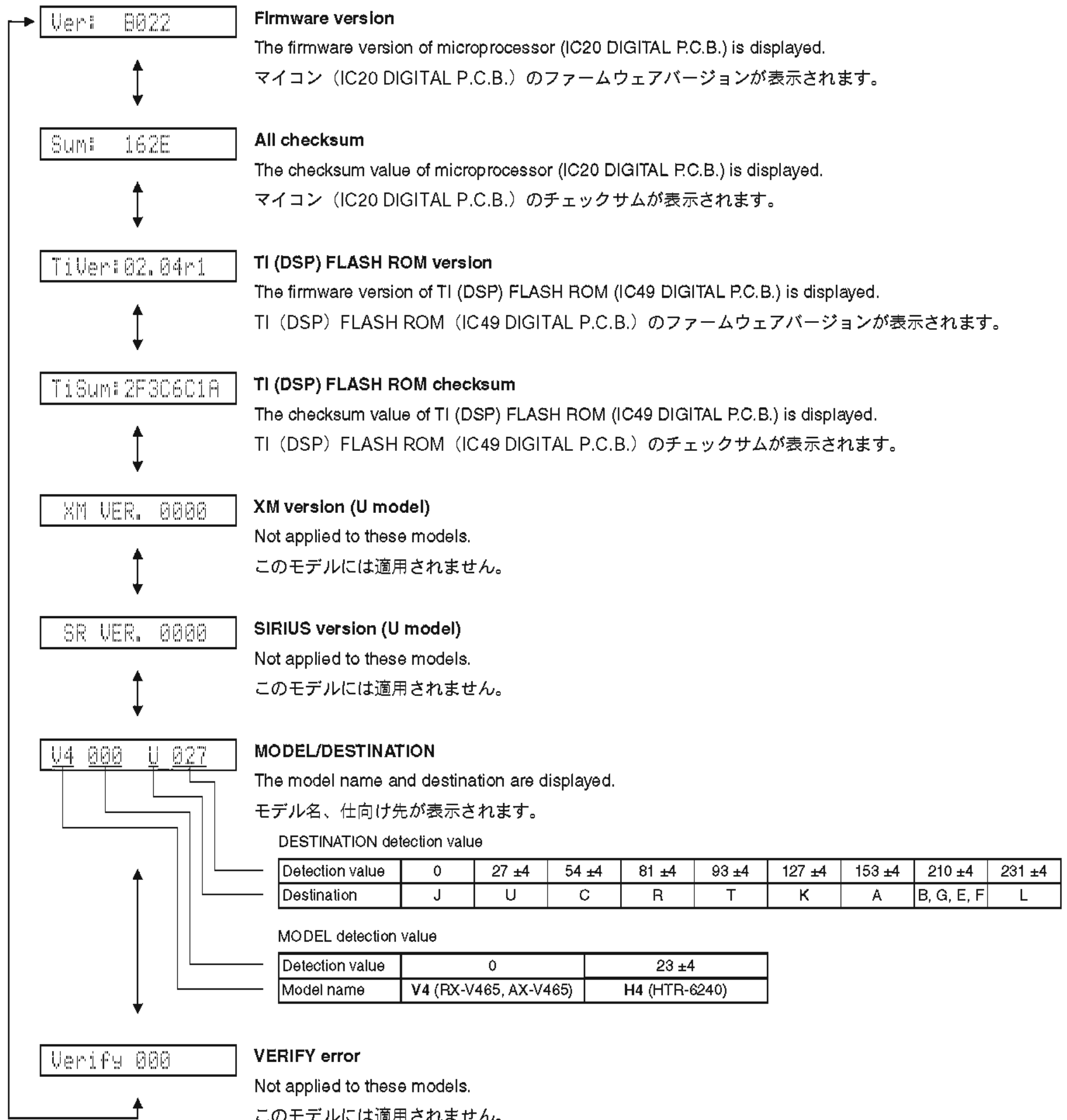

■ DISPLAY DATA

● V4001 : 18-MT-09GNK (OPERATION P.C.B.)

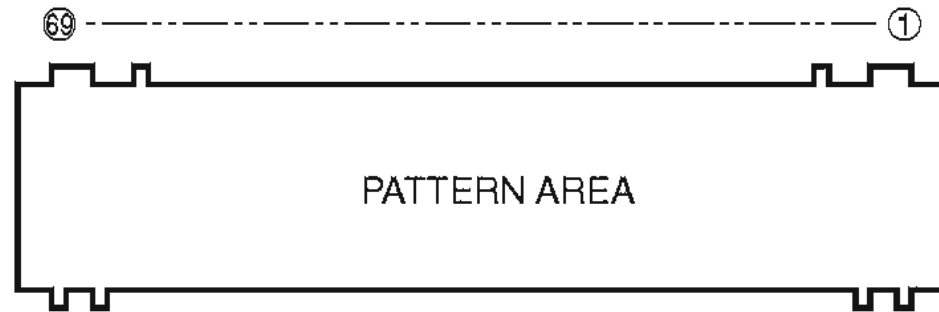

● PIN CONNECTION

Pin No.	69	68	67	66	65	64	63	62	61	60	59	58	57	56	55	54	53	52	51	50	49	48	47	46	45	44	43	42	41	40	39	38	37	36	35
Connection	F2	NX	NP	NP	P1	P2	P3	P4	P5	P6	P7	P8	P9	P10	P11	P12	P13	P14	P15	P16	P17	P18	P19	P20	P21	P22	P23	P24	P25	P26	P27	P28	P29	P30	P31

Pin No.	34	33	32	31	30	29	28	27	26	25	24	23	22	21	20	19	18	17	16	15	14	13	12	11	10	9	8	7	6	5	4	3	2	1
Connection	P32	P33	P34	P35	P36	NX	NX	NX	NX	NX	NX	NX	18G	17G	16G	15G	14G	13G	12G	11G	10G	9G	8G	7G	6G	5G	4G	3G	2G	1G	NP	NP	NX	F1

Note : 1) F1, F2 Filament pin 2) NP No pin 3) NX No extend pin 4) 1G-18G Grid pin

● GRID ASSIGNMENT

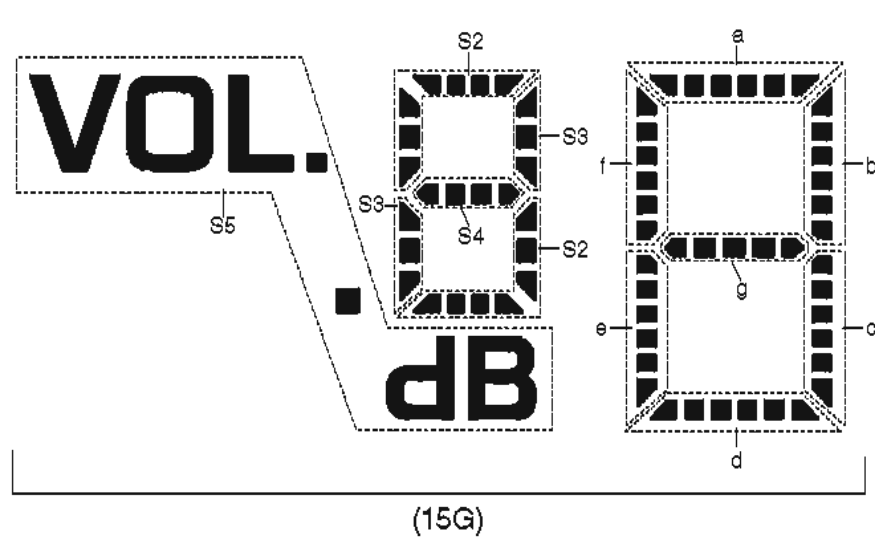
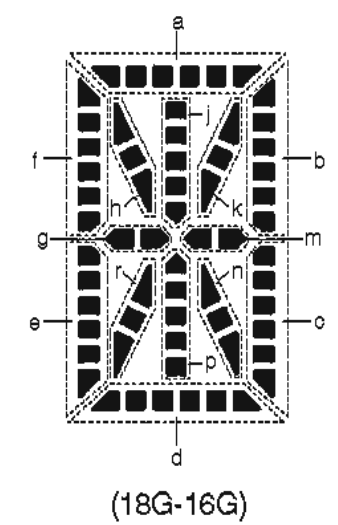
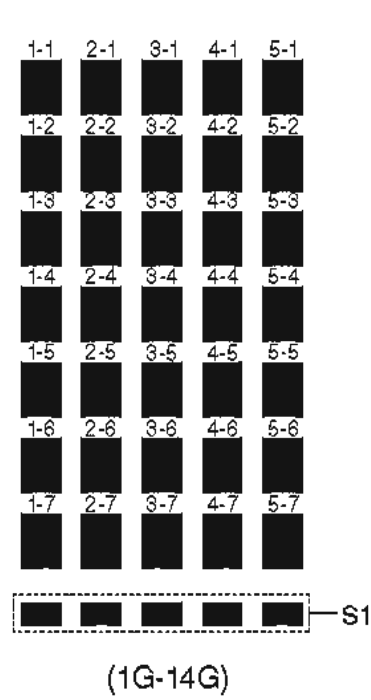
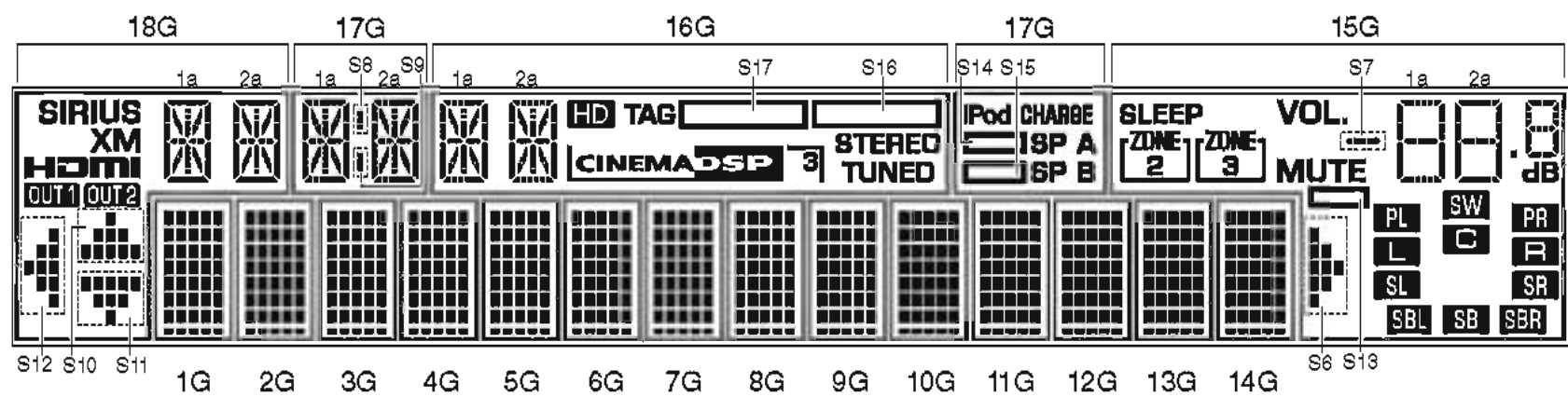

RX-V465/HTR-6240/AX-V465

● ANODE CONNECTION

	18G	17G	16G	15G	1G-14G
P1	1a	1a	1a	S5	1-1
P2	1h	1h	1h	S7	2-1
P3	1j	1j	1j	1d	3-1
P4	1k	1k	1k	2d	4-1
P5	1b	1b	1b	S2	5-1
P6	1f	1f	1f	1e	1-2
P7	1m	1m	1m	2e	2-2
P8	1g	1g	1g	S3	3-2
P9	1c	1c	1c	1c	4-2
P10	1e	1e	1e	2c	5-2
P11	1r	1r	1r	S4	1-3
P12	1p	1p	1p	1g	2-3
P13	1n	1n	1n	2g	3-3
P14	1d	1d	1d	1f	4-3
P15	2a	2a	2a	2f	5-3
P16	2h	2h	2h	1b	1-4
P17	2j	2j	2j	2b	2-4
P18	2k	2k	2k	1a	3-4
P19	2b	2b	2b	2a	4-4
P20	2f	2f	2f	FL	5-4
P21	2m	2m	2m	SW	1-5
P22	2g	2g	2g	RI	2-5
P23	2c	2c	2c	L	3-5
P24	2e	2e	2e	C	4-5
P25	2r	2r	2r	R	5-5
P26	2p	2p	2p	SL	1-6
P27	2n	2n	2n	SR	2-6
P28	2d	2d	2d	SBL	3-6
P29	SIRIUS	S8	HD	BB	4-6
P30	XM	S9	TAG	SBR	5-6
P31	HDMI	Pod CHARGE	CINEMA DSP	S6	1-7
P32	OUT1	SP B	3	S13	2-7
P33	OUT2	S15	STEREO	MUTE	3-7
P34	S12	SP A	TUNED	ZONE 2	4-7
P35	S10	S14	S17	ZONE 3	5-7
P36	S11	-	S16	SLEEP	S1

IC DATA

IC44: D70YE101BRFP266 (DIGITAL P.C.B.)
Decoder/Post processor

* No replacement part available. / サービス部品供給なし

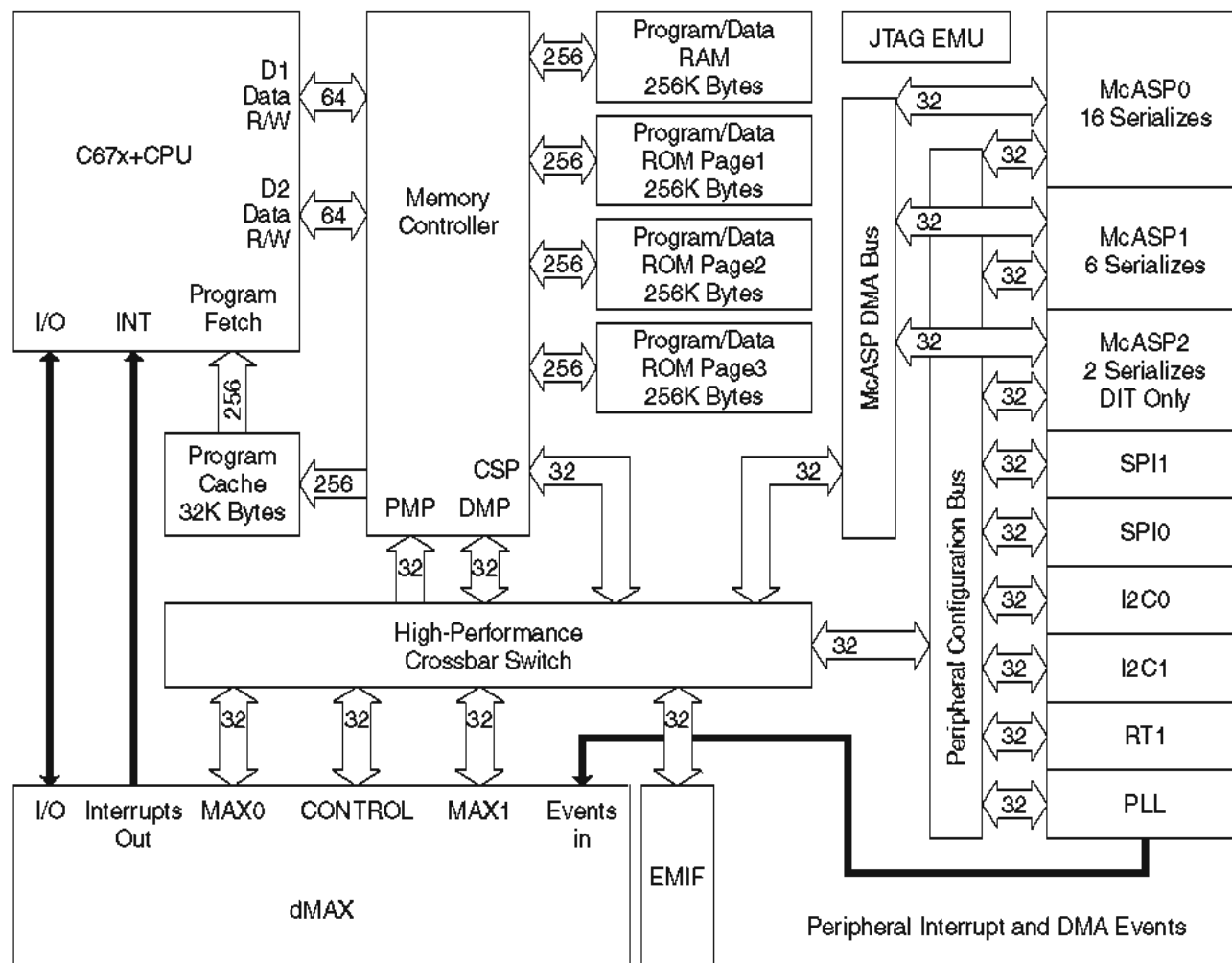
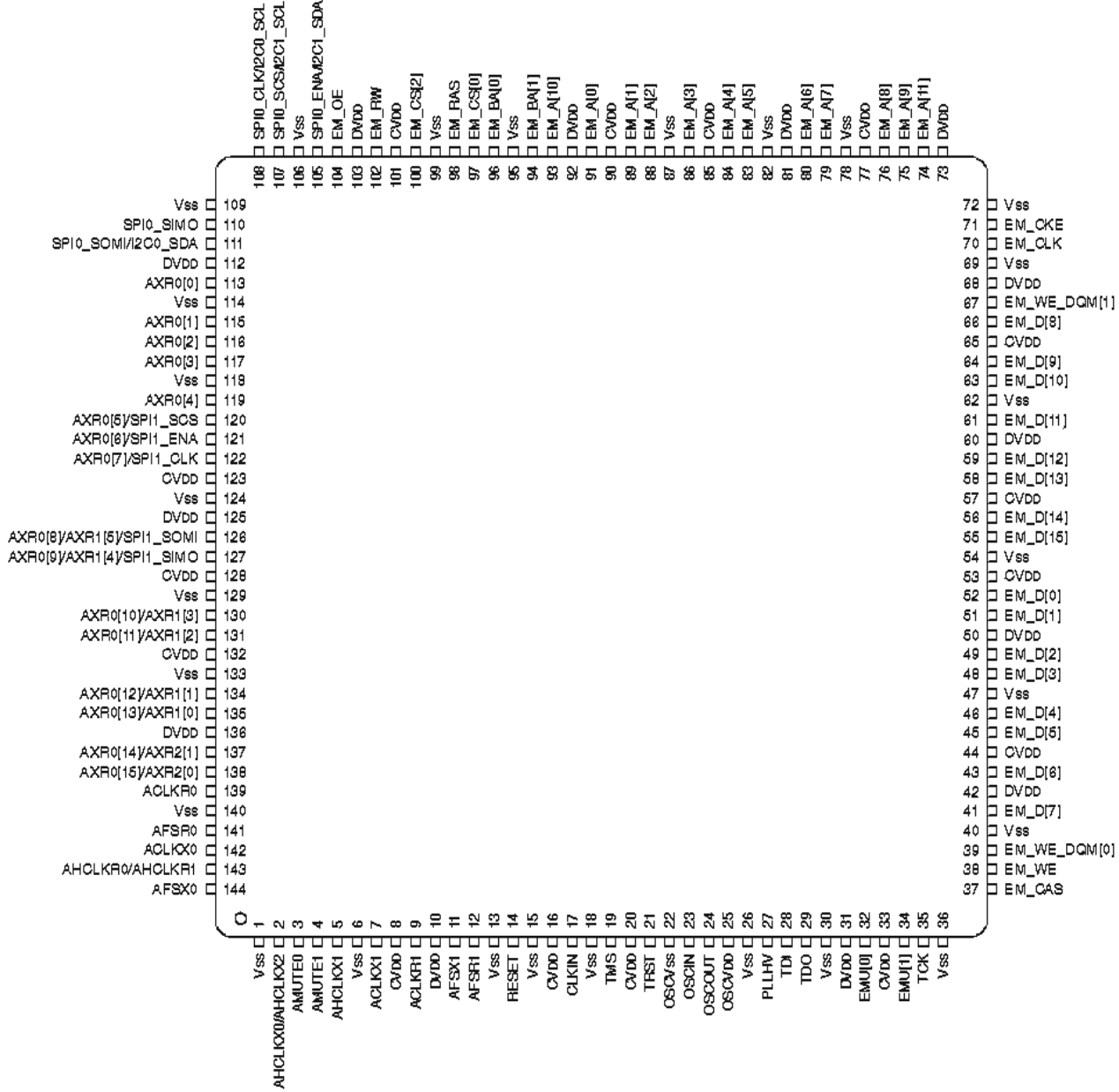

No.	Function Name (P.C.B.)	TYPE ⁽¹⁾	PULL ⁽²⁾	GPIO ⁽³⁾	Detail of Function
1	VSS				
2	AHCLKX0/AHCLKX2	IO	-	Y	McASP0 and McASP2 transmit master clock
3	AMUTE0	IO	-	Y	McASP0 mute output
4	AMUTE1	IO	-	Y	McASP1 mute output
5	AHCLKX1	IO	-	Y	McASP1 transmit master clock
6	VSS				
7	ACLKX1	IO	-	Y	McASP1 transmit bit clock
8	CVDD				
9	ACLKR1	IO	-	Y	McASP1 receive bit clock
10	DVDD				
11	AFSX1	IO	-	Y	McASP1 transmit frame Sync (L/R clock)
12	AFSR1	IO	-	Y	McASP1 receive frame Sync (L/R clock)
13	VSS				
14	RESET	IO	-	N	Device reset pin
15	VSS				
16	CVDD				
17	CLKIN	IO	-	N	Alternate clock input (3.3-V LVCMOS input)
18	VSS				
19	TMS	IO	IPU	N	Test mode select
20	CVDD				
21	TRST	IO	IPU	N	Test reset
22	OSCVSS	PWR	-	N	Oscillator Vss tap point (for filter only)
23	OSCIN	IO	-	N	1.2-V oscillator input
24	NC	O	-	N	
25	OSCVDD	PWR	-	N	Oscillator 1.2-V Vpp tap point (for filter only)
26	VSS				
27	PLLHV	PWR	-	N	PLL 3.3-V supply input (requires external filter)
28	TDI	IO	IPU	N	Test data in
29	TDO	OZ	IPU	N	Test data out
30	VSS				
31	DVDD				
32	EMU[0]	IO	IPU	N	Emulation pin 0
33	CVDD				
34	EMU[1]	IO	IPU	N	Emulation pin 1
35	TCK	IO	IPU	N	Test clock
36	Ground(Vss)				
37	EM_CAS	O	-	N	SDRAM column address strobe
38	EM_WE	O	-	N	SDRAM write enable
39	EM_WE_DQM[0]	O	-	N	Write enable or byte enable for EM_D [7:0]
40	VSS				
41	EM_D[7]	IO	-	N	EMIF data bus [lower 16-bits]
42	DVDD				
43	EM_D[6]	IO	-	N	EMIF data bus [lower 16-bits]
44	CVDD				
45	EM_D[5]	IO	-	N	EMIF data bus [lower 16-bits]
46	EM_D[4]	IO	-	N	EMIF data bus [lower 16-bits]
47	VSS				
48	EM_D[3]	IO	-	N	EMIF data bus [lower 16-bits]
49	EM_D[2]	IO	-	N	EMIF data bus [lower 16-bits]
50	DVDD				
51	EM_D[1]	IO	-	N	EMIF data bus [lower 16-bits]
52	EM_D[0]	IO	-	N	EMIF data bus [lower 16-bits]
53	CVDD				
54	VSS				
55	EM_D[15]	IO	-	N	EMIF data bus [lower 16-bits]
56	EM_D[14]	IO	-	N	EMIF data bus [lower 16-Bits]
57	CVDD				
58	EM_D[13]	IO	-	N	EMIF data bus [lower 16-Bits]
59	EM_D[12]	IO	-	N	EMIF data bus [lower 16-Bits]
60	DVDD				
61	EM_D[11]	IO	-	N	EMIF data bus [lower 16-Bits]

No.	Function Name (P.C.B.)	TYPE ⁽¹⁾	PULL ⁽²⁾	GPIO ⁽³⁾	Detail of Function
62	VSS				
63	EM_D[10]	IO	-	N	EMIF data bus [lower 16-Bits]
64	EM_D[9]	IO	-	N	EMIF data bus [lower 16-Bits]
65	CVDD				
66	EM_D[8]	IO	-	N	EMIF data bus [lower 16-bits]
67	EM_WE_DQM[1]	O	-	N	Write enable or byte enable for EM_D [15:8]
68	DVDD				
69	VSS				
70	EM_CLK	O	-	N	SDRAM clock
71	EM_CKE	O	-	N	SDRAM clock enable
72	VSS				
73	DVDD				
74	EM_A[11]	O	-	N	EMIF address bus
75	EM_A[9]	O	-	N	EMIF address bus
76	EM_A[8]	O	-	N	EMIF address bus
77	CVDD				
78	VSS				
79	EM_A[7]	O	-	N	EMIF address bus
80	EM_A[6]	O	-	N	EMIF address bus
81	DVDD				
82	VSS				
83	EM_A[5]	O	-	N	EMIF address bus
84	EM_A[4]	O	-	N	EMIF address bus
85	CVDD				
86	EM_A[3]	O	-	N	EMIF address bus
87	VSS				
88	EM_A[2]	O	-	N	EMIF address bus
89	EM_A[1]	O	-	N	EMIF address bus
90	CVDD				
91	EM_A[0]	O	-	N	EMIF address bus
92	DVDD				
93	EM_A[10]	O	-	N	EMIF address bus
94	EM_BA[1]	O	-	N	SDRAM bank address and asynchronous memory Low-Order address
95	VSS				
96	EM_BA[0]	O	-	N	SDRAM bank address and asynchronous memory Low-Order address
97	EM_CS[0]	O	-	N	SDRAM chip select
98	EM_RAS	O	-	N	SDRAM row address strobe
99	VSS				
100	EM_CS[2]	O	-	N	Asynchronous memory chip Select
101	CVDD				
102	NC	O	-	N	Asynchronous memory read/not write
103	DVDD				
104	EM_OE	O	-	N	SDRAM output enable
105	SPI0_ENA/I2C1_SDA	IO	-	Y	SPI0 enable (ready) or I2c1 serial data
106	VSS				
107	SPI0_ENA/I2C1_SCL	IO	-	Y	SPI0 enable (ready) or I2c1 serial clock
108	SPI0_CLK/I2C0_SCL	IO	-	Y	SPI0 serial clock or I2c0 serial clock
109	VSS				
110	SPI0_SIMO	IO	-	Y	SPI0 data pin slave in master out
111	SPI0_SOMI/I2C0_SDA	IO	-	Y	SPI0 data pin slave out master in or I2C0 serial data
112	DVDD				
113	AXR0[0]	IO	-	Y	McASP0 serial data 0
114	VSS				
115	AXR0[1]	IO	-	Y	McASP0 serial data 1
116	AXR0[2]	IO	-	Y	McASP0 serial data 2
117	AXR0[3]	IO	-	Y	McASP0 serial data 3
118	VSS				
119	AXR0[4]	IO	-	Y	McASP0 serial data 4
120	SPI1_SCS	IO	-	Y	McASP0 serial data 5 or SPI1 slave chip select
121	SPI1_ENA	IO	-	Y	McASP0 serial data 6 or SPI1 enable (ready)
122	SPI1_CLK	IO	-	Y	McASP0 serial data 7 or SPI1 serial clock

No.	Function Name (P.C.B.)	TYPE ⁽¹⁾	PULL ⁽²⁾	GPIO ⁽³⁾	Detail of Function
123	CVDD				
124	VSS				
125	DVDD				
126	/SPI1_SOMI	IO	-	Y	McASP0 serial data 8 or McASP1 serial data 5 or SPI1 data pin slave out master in
127	/SPI1_SIMO	IO	-	Y	McASP0 serial data 9 or McASP1 serial data 4 or SPI1 data pin slave in master out
128	CVDD				
129	VSS				
130	AXR0[10]	IO	-	Y	McASP0 serial data 10 or McASP1 serial data 3
131	AXR0[11]	IO	-	Y	McASP0 serial data 11 or McASP1 serial data 2
132	CVDD				
133	VSS				
134	AXR0[12]	IO	-	Y	McASP0 serial data 12 or McASP1 serial data 1
135	AXR0[13]	IO	-	Y	McASP0 serial data 13 or McASP1 serial data 0
136	DVDD				
137	AXR0[14]	IO	-	Y	McASP0 serial data 14 or McASP2 serial data 1
138	AXR0[15]	IO	-	Y	McASP0 serial data 15 or McASP2 serial data 0
139	ACLKR0	IO	-	Y	McASP0 receive bit clock
140	VSS				
141	AFSR0	IO	-	Y	McASP0 receive frame Sync (L/R clock)
142	ACLKX0	IO	-	Y	McASP0 transmit bit clock
143	AHCLKR0/AHCLKR1	IO	-	Y	McASP0 and McASP1 receive master clock
144	AFSX0	IO	-	Y	McASP0 transmit frame Sync (L/R clock)

IC402: M66003-0131FP (OPERATION P.C.B.)
FL display driver

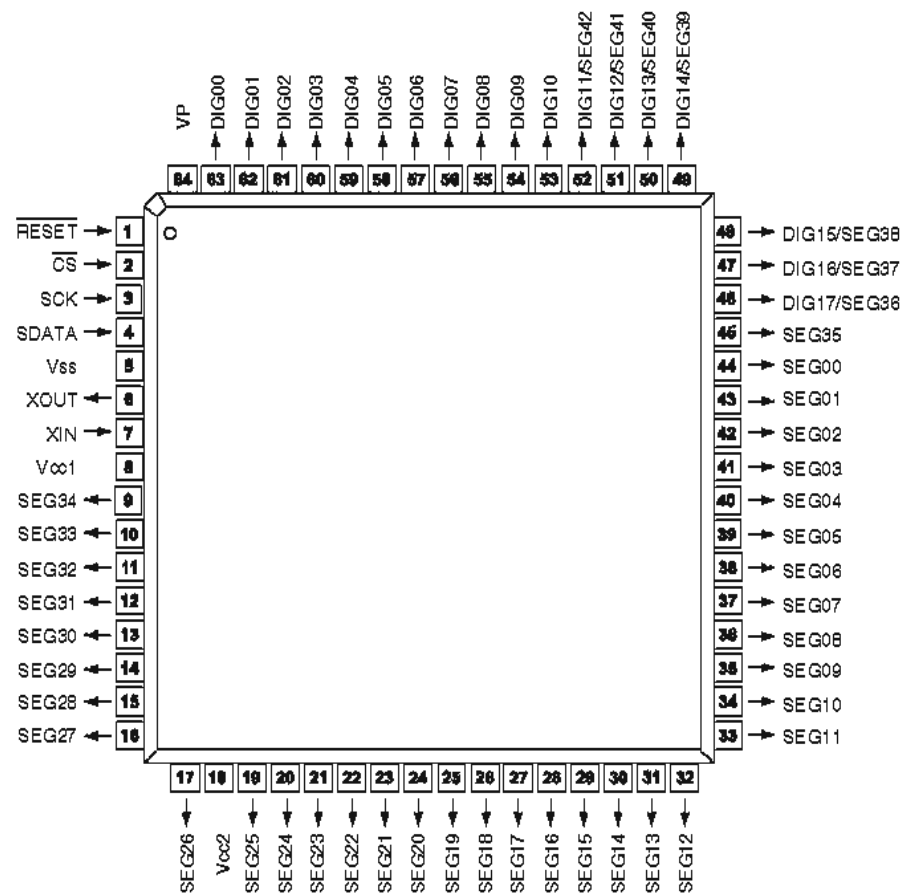
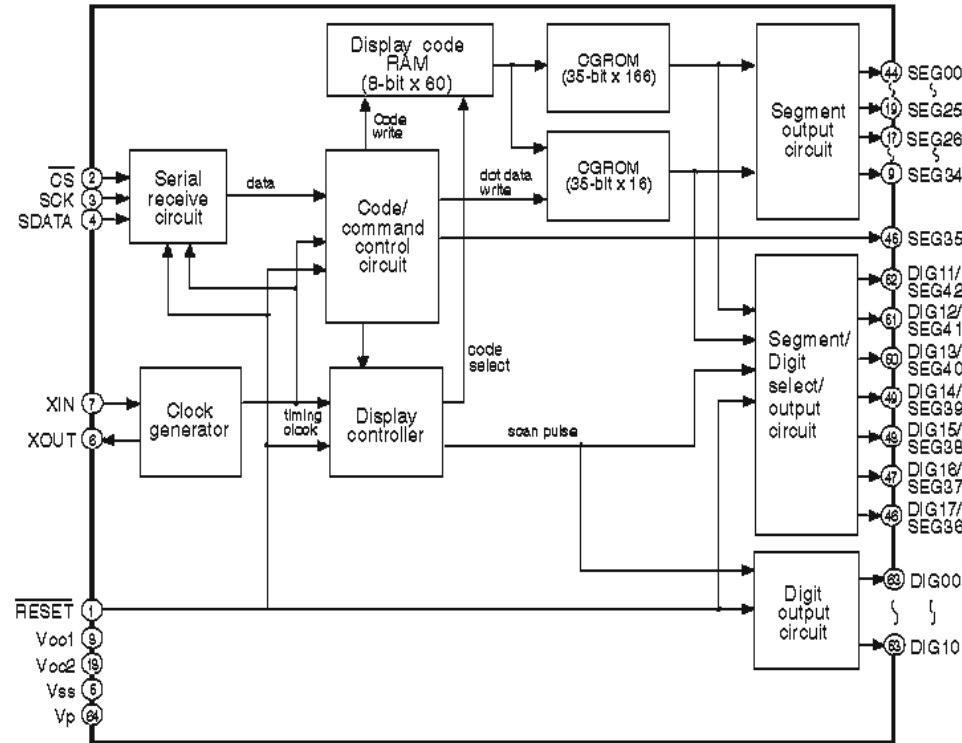

Pin No.	Port Name	Function Name	I/O	Detail of Function
1	RESET	/RESET	Reset input	When "L," M66003 is initialized.
2	CS	/CEFL	Chip select input	When "L," communication with the MCU is possible.
3	SCK	CKFL	Shift clock input	When "H," any instruction from the MCU is neglected.
4	SDATA	DTFL	Serial data input	Serial input data is taken and shifted by the positive edge of SCK.
5	Vss	VSS		GND (0V)
6	XOUT	XOUT	Clock out	When use as a CR oscillator, connect external resistor and capacitor.
7	XIN	XIN	Clock in	When use an external clock input external clock to XIN, and XOUT must be opened.

RX-V465/HTR-6240/
AX-V465

Pin No.	Port Name	Function Name	I/O	Detail of Function
8	Vcc1	VDD		Positive power supply for internal logic.
9	SEG34	P11	Segment output	Connect to segment (anode) pins of VFD.
10	SEG33	P2		
11	SEG32	P3		
12	SEG31	P4		
13	SEG30	P5		
14	SEG29	P6		
15	SEG28	P7		
16	SEG27	P8		
17	SEG26	P9		
18	Vcc2	VDD		Positive power supply for DIG and SEG outputs.
19	SEG25	P10	Segment output	Connect to segment (anode) pins of VFD.
20	SEG24	P11		
21	SEG23	P12		
22	SEG22	P13		
23	SEG21	P14		
24	SEG20	P15		
25	SEG19	P16		
26	SEG18	P17		
27	SEG17	P18		
28	SEG16	P19		
29	SEG15	P20		
30	SEG14	P21		
31	SEG13	P22		
32	SEG12	P23		
33	SEG11	P24		
34	SEG10	P25		
35	SEG09	P26		
36	SEG08	P27		
37	SEG07	P28		
38	SEG06	P29		
39	SEG05	P30		
40	SEG04	P31		
41	SEG03	P32		
42	SEG02	P33		
43	SEG01	P34		
44	SEG00	P35		
45	SEG35	P36		
46	SEG36	P37		
47	DIG16/SEG37	G17	Digital output	Connect to digit (grid) pins of VFD.
48	DIG15/SEG38	G16		
49	DIG14/SEG39	G15		
50	DIG13/SEG40	G14		
51	DIG12/SEG41	G13		
52	DIG11/SEG42	G12		
53	DIG10	G11		
54	DIG09	G10		
55	DIG08	G9		
56	DIG07	G8		
57	DIG06	G7		
58	DIG05	G6		
59	DIG04	G5		
60	DIG03	G4		
61	DIG02	G3		
62	DIG01	G2		
63	DIG00	G1		
64	VP	VP		Negative power supply to pull down.

IC41: LC89058WD-E (DIGITAL P.C.B.)
Digital audio interface receiver

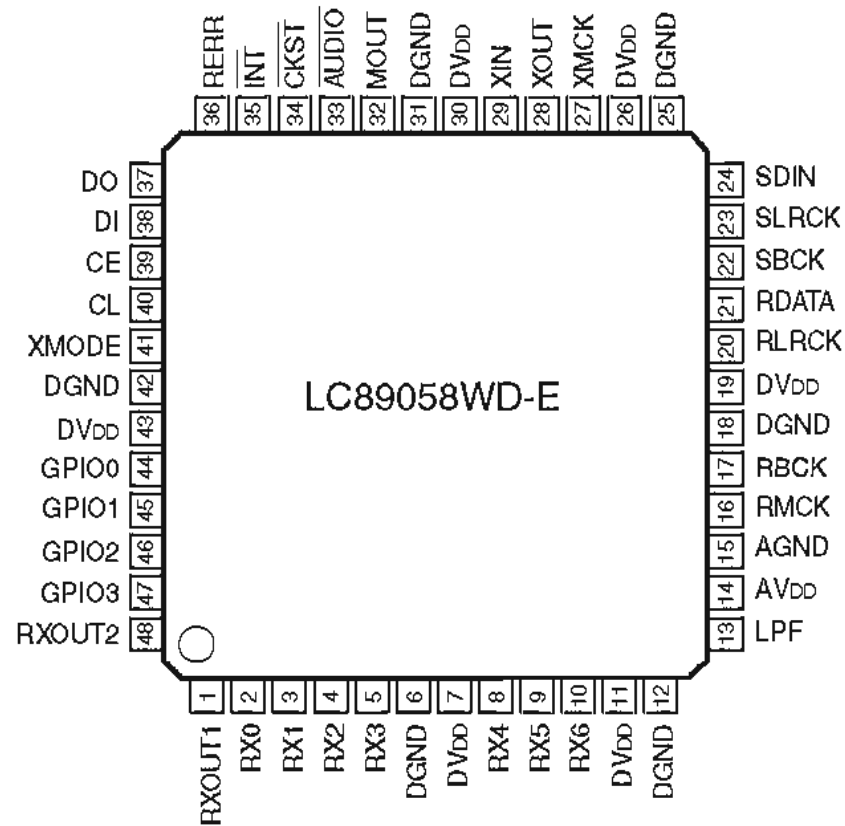
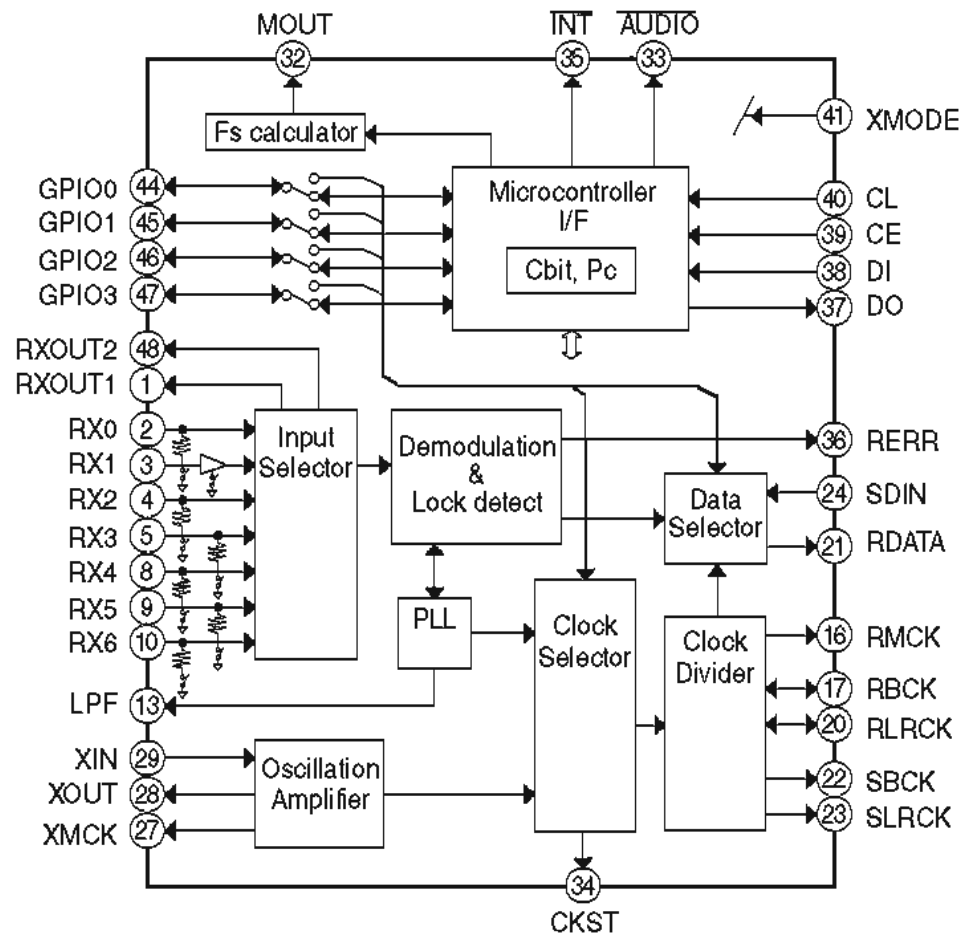

Pin No.	Function Name	I/O	Detail of Function
1	RXOUT1	O	RX0-6 input S/PDIF through output pin 1
2	RX0	I _s (pd)	5V withstand voltage TIL input level compatible S/PDIF input pin (connected to GND when RX1 is set)
3	RX1	I(pd)	Co-axial compatible S/PDIF input pin (supported demodulation sampling frequency of up to 96 kHz)
4	RX2	I _s (pd)	5V withstand voltage TIL input level compatible S/PDIF input pin (connected to GND when RX1 is set)
5	RX3	I _s (pd)	5V withstand voltage TIL input level compatible S/PDIF input pin
6	DGND		Digital GND
7	DVDD		Digital power supply (3.3V)
8	RX4	I _s (pd)	5V tolerable TIL input level compatible S/PDIF input pin
9	RX5	I _s (pd)	5V tolerable TIL input level compatible S/PDIF input pin
10	RX6	I _s (pd)	5V tolerable TIL input level compatible S/PDIF input pin
11	DVDD		Digital power supply (3.3V)
12	DGND		Digital GND
13	LPF	O	PLL loop filter connection pin
14	AVDD		Analog power supply (3.3V)
15	AGND		Analog GND
16	RMCK	O	R system clock output pin (VCO, 512fs, XIN)
17	RBCK	O/I	R system bit clock I/O pin (64fs)
18	DGND		Digital GND
19	DVDD		Digital power supply (3.3V)
20	RLRCK	O/I	R system LR clock I/O pin (fs)
21	RDATA	O	Serial audio data output pin
22	SBCK	O	S system bit clock output pin (16fs, 32fs, 64fs, 128fs)
23	SLRCK	O	S system LR clock output pin (fs/4, fs/2, fs, 2fs)
24	SDIN	I _s	External serial audio data input pin
25	DGND		Digital GND
26	DVDD		Digital power supply (3.3V)
27	XMCK	O	Oscillation amplifier clock output pin
28	XOUT	O	Output pin connected to the resonator
29	XIN	I	External clock input pin, connected to the resonator (12.288 MHz or 24.576 MHz)
30	DVDD		Digital power supply (3.3V)
31	DGND		Digital GND
32	MOUT	I/O	Emphasis information I input fs monitor output I chip address setting input pin
33	AUDIO	I/O	Channel status bit 1 output I chip address setting input pin
34	CKST	I/O	Clock switching transition period signal output I master/slave setting input pin
35	INT	I/O	Microcontroller interrupt signal output I pins 44-48 I/O setting input pin
36	RERR	O	PLL lock error and data error flag output pin
37	DO	O	CCB microcontroller I/F, read data output pin (3-state)
38	DI	I _s	CCB microcontroller I/F, write data input pin
39	CE	I _s	CCB microcontroller I/F, chip enable input pin
40	CL	I _s	CCB microcontroller I/F, clock input pin
41	XMODE	I _s	System reset input pin
42	DGND		Digital GND
43	DVDD		Digital power supply (3.3V)
44	GPI00	O/I	General-purpose I/O pin I selector input pin (output referred to RMCK pin)
45	GPI01	O/I	General-purpose I/O pin I selector input pin (output referred to RBCK pin)
46	GPI02	O/I	General-purpose I/O pin I selector input pin (output referred to RLRCK pin)
47	GPI03	O/I	General-purpose I/O pin I selector input pin (output referred to RDATA pin)
48	RXOUT2	O	RX0-6 input S/PDIF through output pin 2

- * Input voltage: 1 = -0.3 to 3.6V, I_s = -0.3 to 5.5V
- * Output voltage: 0 = -0.3 to 3.6V
- * Pins 2, 4, 5, 8, 9, 10, 24, 38, 39, 40, and 41 have an internal pull-down resistor (Pd). Their level is fixed when they are unselected.
- * Pins 32 and 33 are input pins for chip address setting when pin 41 is held at the low level.
- * Pin 34 serves as the input pin for designating as the master or slave when pin 41 is held at the low level.
- * Pin 35 serves as the input pin for configuring the I/O of pins 44 to 47 when pin 41 is held at the low level.
- * The DVDD and AVDD pins must be held at the same level and turned on and off at the same timing to preclude latch-up conditions.

IC153: R2A15220FP (MAIN P.C.B.)
8-channel electronic volume with 11 input selector and tone control

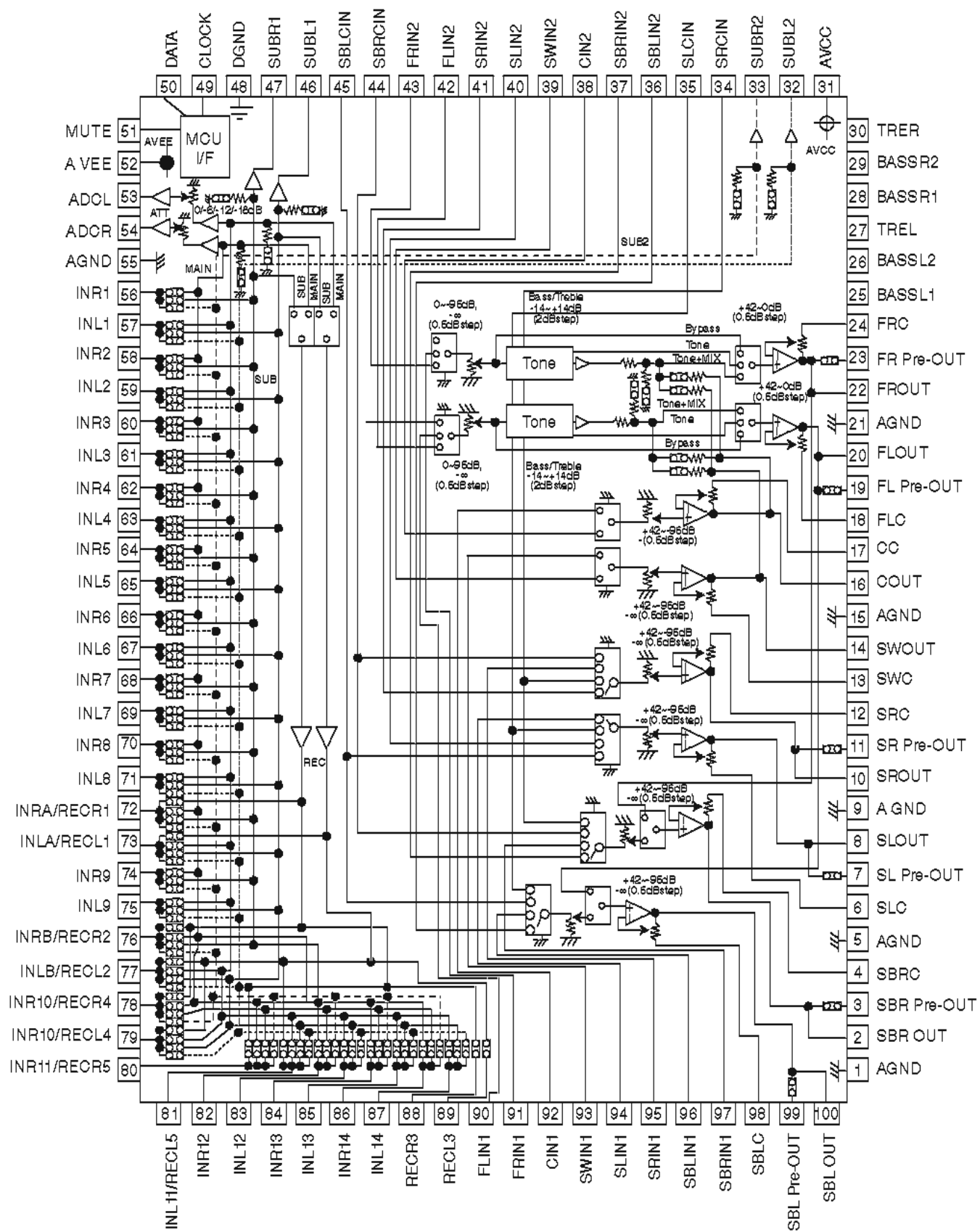

RX-V465/HTR-6240/
AX-V465

Pin No.	Port name	Function Name	Detail of Function
1	AGND	AE	Analog ground of internal circuit
2	SBROUT	VOSBL	Output pin of FL/FR/C/SW/SL/SR/SBL/SBR channel
3	SBR Pre-OUT	VOPSBL	Pre-output pin of FL/FR/SL/SR/SBL/SBR channel
4	SBRC	AE	Connects capacitor for reducing click noise of L/R/C/SW/SL/SR/SBL/SBR channel volume
5	AGND	AE	Analog ground of internal circuit
6	SLC	VOPSR	Connects capacitor for reducing click noise of L/R/C/SW/SL/SR/SBL/SBR channel volume
7	SL Pre-OUT	VOSR	Pre-output pin of FL/FR/SL/SR/SBL/SBR channel
8	SLOUT	AE	Output pin of FL/FR/C/SW/SL/SR/SBL/SBR channel
9	AGND	AE	Analog ground of internal circuit
10	SROUT	VOSL	Output pin of FL/FR/C/SW/SL/SR/SBL/SBR channel
11	SR Pre-OUT	VOPSL	Pre-output pin of FL/FR/SL/SR/SBL/SBR channel
12	SRC	AE	Connects capacitor for reducing click noise of L/R/C/SW/SL/SR/SBL/SBR channel volume
13	SWC	AE	Connects capacitor for reducing click noise of L/R/C/SW/SL/SR/SBL/SBR channel volume
14	SWOUT	VOSW	Output pin of FL/FR/C/SW/SL/SR/SBL/SBR channel
15	AGND	AE	Analog ground of internal circuit
16	COUT	VOC	Output pin of FL/FR/C/SW/SL/SR/SBL/SBR channel
17	CC	AE	Connects capacitor for reducing click noise of L/R/C/SW/SL/SR/SBL/SBR channel volume
18	FLC	AE	Connects capacitor for reducing click noise of L/R/C/SW/SL/SR/SBL/SBR channel volume
19	FL Pre-OUT	VOPFR	Pre-output pin of FL/FR/SL/SR/SBL/SBR channel
20	FLOUT	VOFR	Output pin of FL/FR/C/SW/SL/SR/SBL/SBR channel
21	AGND	POE	Analog ground of internal circuit
22	FROUT	VOFL	Output pin of FL/FR/C/SW/SL/SR/SBL/SBR channel
23	FR Pre-OUT	VOPFL	Pre-output pin of FL/FR/SL/SR/SBL/SBR channel
24	FRC	AE	Connects capacitor for reducing click noise of L/R/C/SW/SL/SR/SBL/SBR channel volume
25	BASSL1	AE	Frequency characteristic setting pin of L/R channel tone control (Bass)
26	BASSL2	AE	Frequency characteristic setting pin of L/R channel tone control (Bass)
27	TREL	AE	Frequency characteristic setting pin of L/R channel tone control (Treble)
28	BASSR1	AE	Frequency characteristic setting pin of L/R channel tone control (Bass)
29	BASSR2	AE	Frequency characteristic setting pin of L/R channel tone control (Bass)
30	TRER	AE	Frequency characteristic setting pin of L/R channel tone control (Treble)
31	AVCC	VCC	Positive power supply to internal circuit
32	SUBL1	N.C.	Output pin for L/R channel SUB1/SUB2 output
33	SUBL2	N.C.	Output pin for L/R channel SUB1/SUB2 output
34	SRCIN	N.C.	3rd multi input pin for SBL/SBR/SL/SR channel volume that is able to swap SBR/SBL with SR/SL
35	SLCIN	N.C.	3rd multi input pin for SBL/SBR/SL/SR channel volume that is able to swap SBR/SBL with SR/SL
36	SBLIN2	8SBR	Multi input pin of L/R/C/SW/SL/SR/SBL/SBR channel (Multi IN 1/2)
37	SBRIN2	8SBL	Multi input pin of L/R/C/SW/SL/SR/SBL/SBR channel (Multi IN 1/2)
38	CIN2	8C	Multi input pin of L/R/C/SW/SL/SR/SBL/SBR channel (Multi IN 1/2)
39	SWIN2	8SW	Multi input pin of L/R/C/SW/SL/SR/SBL/SBR channel (Multi IN 1/2)
40	SLIN2	8SR	Multi input pin of L/R/C/SW/SL/SR/SBL/SBR channel (Multi IN 1/2)
41	SRIN2	8SL	Multi input pin of L/R/C/SW/SL/SR/SBL/SBR channel (Multi IN 1/2)
42	FLIN2	8FR	Multi input pin of L/R/C/SW/SL/SR/SBL/SBR channel (Multi IN 1/2)
43	FRIN2	8FL	Multi input pin of L/R/C/SW/SL/SR/SBL/SBR channel (Multi IN 1/2)
44	SBRCIN	Z2L	3rd multi input pin for SBL/SBR/SL/SR channel volume that is able to swap SBR/SBL with SR/SL
45	SBLCIN	Z2R	3rd multi input pin for SBL/SBR/SL/SR channel volume that is able to swap SBR/SBL with SR/SL
46	SUBL1	Z2R	Output pin for L/R channel SUB1/SUB2 output
47	SUBR1	Z2L	Output pin for L/R channel SUB1/SUB2 output
48	DGND	MG	Digital ground of internal circuit
49	DATA	VOL_SCK	Input pin of control data
50	CLOCK	VOL_MOSI	Input pin of control clock
51	MUTE	AE	Outside mute control pin
52	AVEE	-	Negative power supply to internal circuit
53	ADCL	ADR	Output pin for L/R channel ADC
54	ADCR	ADL	Output pin for L/R channel ADC
55	AGND	AE	Analog ground of internal circuit
56	INR1	AU2L	Input pin of L/R channel (Input selector)
57	INL1	AU2R	Input pin of L/R channel (Input selector)
58	INR2	AU1L	Input pin of L/R channel (Input selector)

Pin No.	Port name	Function Name	Detail of Function
59	INL2	AU1R	Input pin of L/R channel (Input selector)
60	INR3	AV-6L	Input pin of L/R channel (Input selector)
61	INL3	AV-6R	Input pin of L/R channel (Input selector)
62	INR4	AV-5L	Input pin of L/R channel (Input selector)
63	INL4	AV-5R	Input pin of L/R channel (Input selector)
64	INR5	PHL	Input pin of L/R channel (Input selector)
65	INL5	PHR	Input pin of L/R channel (Input selector)
66	INR6	SRL	Input pin of L/R channel (Input selector)
67	INL6	SRR	Input pin of L/R channel (Input selector)
68	INR7	IPL	Input pin of L/R channel (Input selector)
69	INL7	IPR	Input pin of L/R channel (Input selector)
70	INR8	XML	Input pin of L/R channel (Input selector)
71	INL8	XMR	Input pin of L/R channel (Input selector)
72	INRA/RECR1	AV-OUT_L	Output pin for L/R channel (input selector)/Output pin for L/R channel REC output
73	INLA/RECL1	AV-OUT_R	Output pin for L/R channel (input selector)/Output pin for L/R channel REC output
74	INR9	USBL	Input pin of L/R channel (Input selector)
75	INL9	USBR	Input pin of L/R channel (Input selector)
76	INRB/RECR2	AOL	Output pin for L/R channel (input selector)/Output pin for L/R channel REC output
77	INLB/RECL2	AOR	Output pin for L/R channel (input selector)/Output pin for L/R channel REC output
78	INR10/RECR4	TUL	Output pin for L/R channel (input selector)/Output pin for L/R channel REC output
79	INL10/RECL4	TUR	Output pin for L/R channel (input selector)/Output pin for L/R channel REC output
80	INR11/RECR5	MIC	Output pin for L/R channel (input selector)/Output pin for L/R channel REC output
81	INL11/RECL5	AE	Output pin for L/R channel (input selector)/Output pin for L/R channel REC output
82	INR12	AUXL	Input pin of L/R channel (Input selector)
83	INL12	AUXR	Input pin of L/R channel (Input selector)
84	INR13	AE	Input pin of L/R channel (Input selector)
85	INL13	AE	Input pin of L/R channel (Input selector)
86	INR14	AE	Input pin of L/R channel (Input selector)
87	INL14	AE	Input pin of L/R channel (Input selector)
88	RECR3	N.C.	Output pin for L/R channel REC output
89	RECL3	N.C.	Output pin for L/R channel REC output
90	FLIN1	DAFR	Multi input pin of L/R/C/SW/SL/SR/SBL/SBR channel (Multi IN 1/2)
91	FRIN1	DAFL	Multi input pin of L/R/C/SW/SL/SR/SBL/SBR channel (Multi IN 1/2)
92	CIN1	DAC	Multi input pin of L/R/C/SW/SL/SR/SBL/SBR channel (Multi IN 1/2)
93	SWIN1	DASW	Multi input pin of L/R/C/SW/SL/SR/SBL/SBR channel (Multi IN 1/2)
94	SLIN1	DASR	Multi input pin of L/R/C/SW/SL/SR/SBL/SBR channel (Multi IN 1/2)
95	SEIN1	DASL	Multi input pin of L/R/C/SW/SL/SR/SBL/SBR channel (Multi IN 1/2)
96	SBLIN1	DASBR	Multi input pin of L/R/C/SW/SL/SR/SBL/SBR channel (Multi IN 1/2)
97	SBRIN1	DASBL	Multi input pin of L/R/C/SW/SL/SR/SBL/SBR channel (Multi IN 1/2)
98	SBLC	AE	Connects capacitor for reducing click noise of L/R/C/SW/SL/SR/SBL/SBR channel volume
99	SBL Pre-OUT	VOPSBR	Pre-output pin of FL/FR/SL/SR/SBL/SBR channel
100	SBL OUT	VOSBR	Output pin of FL/FR/C/SW/SL/SR/SBL/SBR channel

IC20: M3087BFKBGP (DIGITAL P.C.B.)
Microprocessor

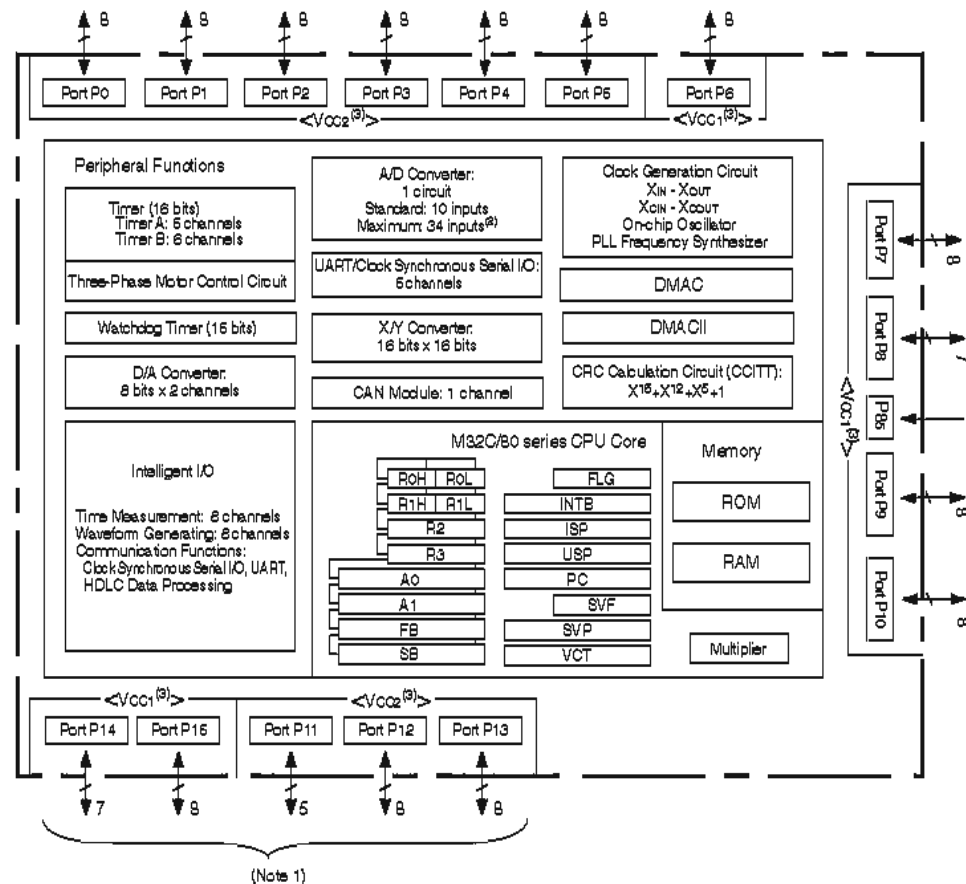

NOTES:
1. Ports P11 to P15 are provided in the 144-pin package only.
2. Included in the 144-pin package only.
3. The supply voltage of M32C/B4T (High-reliability version) must be $V_{CC1}=V_{CC2}$.

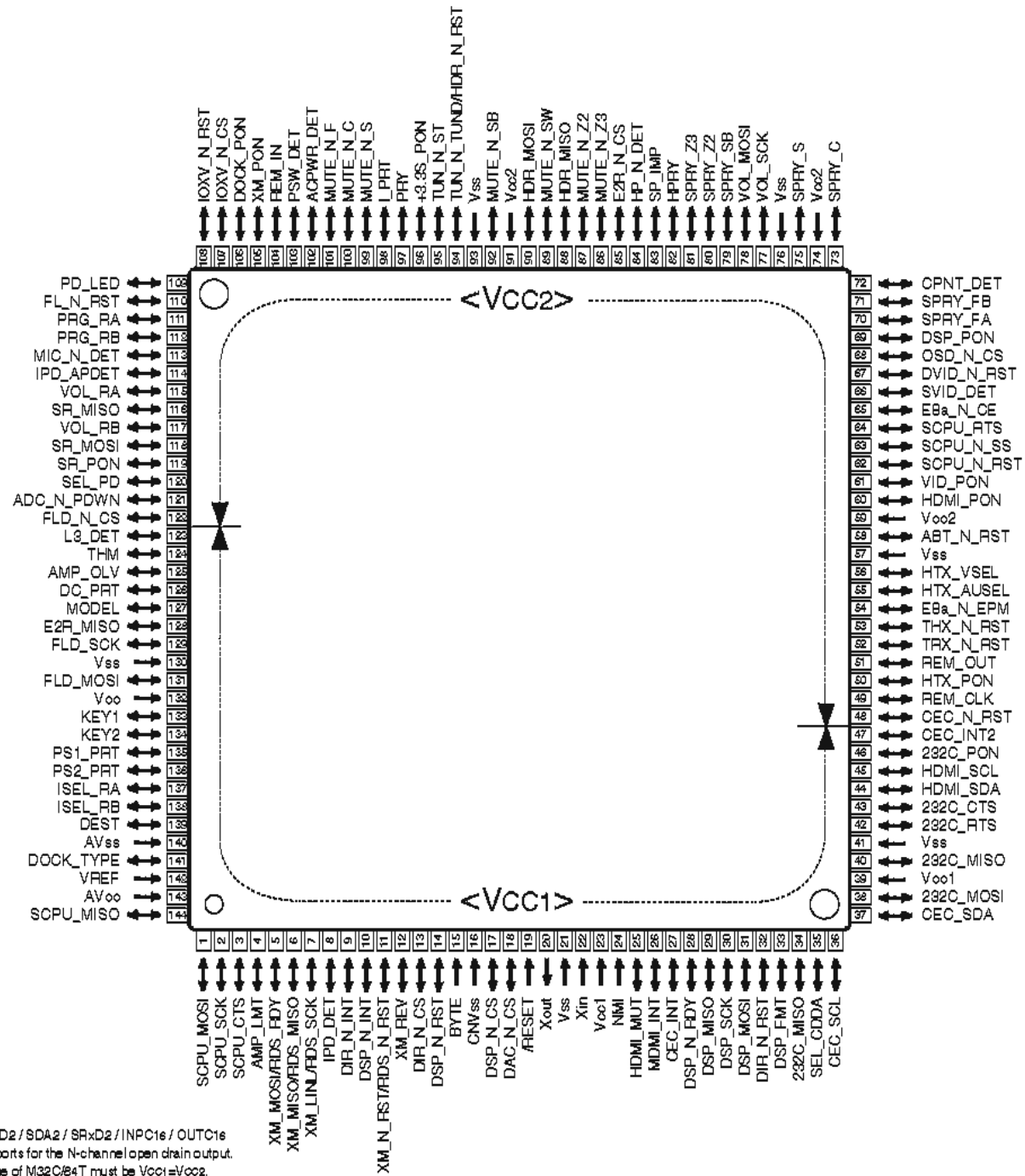

NOTES:
1. P70 / TA0out / TxD2 / SDA2 / SRxD2 / INPC16 / OUTC16
2. P70 and P71 are ports for the N-channel open drain output.
3. The supply voltage of M32C/B4T must be $V_{CC1}=V_{CC2}$.

Pin No.	Port Name	Function Name (P.C.B.)	I/O					Detail of Function	
			Power On	Stby Thrh	standby	Stby Sleep	MCU Sleep		
1	TXD4 P96/ANEX1/TXD4/ SDA4/SRXD4	IPD_MOSI	SO	○	○	○	○	Asynchronous data output for iPod	
2	P95	SCPU_SCK	○	○	○	○	○		
3	P94 P94/DA1/TB4in/ CTS4/RTS4/SS4	SCPU_CTS	SI	I	I	○	○	Input for transmission control for SubCPU (clear to send)	
4	DA0 P93/DA0/TB3in/ CTS3/RTS3/SS3	AMP_LMT	DA	I	I	I	I	Limiter control output	
5	TB2in	RDS_RDY	TRM	○	○	○	○	RDS RRADY input (G model)	
	P92		○	○	○	○	○	(U, C, R, T, K, A, B, E, F, L, J models)	
6	RXD3	RDS_MISO	SI	○	○	○	○	Synchronous data input for RDS (G model)	
	P91		○	○	○	○	○	(U, C, R, T, K, A, B, E, F, L, J models)	
7	CLK3	RDS_SCK	SO	○	○	○	○	Synchronous clock output for RDS IC (G model)	
	P90		○	○	○	○	○	Requires low level standby (U, C, R, T, K, A, B, E, F, L, J models)	
8	INT8 P146/INT8	IPD_DET	IRQ	IRQ	IRQ	IRQ	○	iPod detection When inserting an iPod into the DOCK H → L Restriction of port: INT is high edge or low edge only	
9	P145 P145/INT7	DIR_N_INT	IRQ	○	○	○	○	DIR interrupt Restriction of port: INT is high edge or low edge only	
10	P144 P144/INT6	DSP_N_INT	IRQ	○	○	○	○	DA70Y interrupt Restriction of port: INT is high edge or low edge only	
11	P143	RDS_N_RST	○	○	○	○	○	RDS reset (G model)	
	P143		○	○	○	○	○	(U, C, R, T, K, A, B, E, F, L, J models)	
12	P142	DIR_SDO	I	○	○	○	○	DIR data input at CDDA writing mode	
13	P141 P141/INPC15/ OUTC15	DIR_N_CS	CS	○	○	○	○	DIR chip select	
14	P140 P140/INPC14/ OUTC14	DSP_N_RST	○	○	○	○	○	DA70Y reset	
15	BYTE BYTE	BYTE	MCU	MCU	MCU	MCU	MCU	MCU	Switch of width of data bus input When set to single chip mode: L (16 bit)
16	CNVss CNVss	CNVss	MCU	MCU	MCU	MCU	MCU	MCU	Processor mode select Low: single chip mode High: To Flash included boot mode To boot mode with hardware resetting of P50=H, P55=L, CNVss=H
17	P87 P87/Xcin	DSP_N_CS	CS	○	○	○	○	○	DA70Y chip select
18	P86 P86/Xcout	DAC_N_CS	CS	○	○	○	○	○	DAC chip select
19	/RESET /RESET	/RESET	MCU	MCU	MCU	MCU	MCU	MCU	Reset
20	Xout Xout	Xout	MCU	MCU	MCU	MCU	MCU	MCU	20 MHz Ceramic resonator
21	Vss Vss	Vss	MCU	MCU	MCU	MCU	MCU	MCU	GND
22	Xin Xin	Xin	MCU	MCU	MCU	MCU	MCU	MCU	20 MHz ceramic resonator
23	Vcc1 Vcc1	Vcc1	MCU	MCU	MCU	MCU	MCU	MCU	Microprocessor power supply
24	/NMI P85/NMI	/NMI	MCU	MCU	MCU	MCU	MCU	MCU	Unused, pull up to Vcc
25	INT2 P84/INT2	HDMI_MUT	IRQ	IRQ	○	○	○	○	HDMI mute input Act H: Mute
26	INT1 P83/INT1	HDMI_INT	IRQ	IRQ	○	○	○	○	Interrupt from HDMI RX
27	INT0 P82/INT0	CEC_N_INT	IRQ	IRQ	○	○	○	○	CEC microprocessor interrupt

Pin No.	Port Name	Function Name (P.C.B.)	I/O					Detail of Function
			Power On	Stby Thrh	Standby	Stby Sleep	MCU Sleep	
28	P81 P81/TA4in/U/INPC15/ OUTC15/CTS5/ RTS5/RTP23	DSP_N_RDY	I	O	O	O	O	DA70Y RDY
	P81	DIR_WCK	I	O	O	O	O	CDDA writing DIR_WCK input
29	RXD5 P80/TA4out/U/ ISRXD0/RXD5	DSP_MISO	SI	O	O	O	O	Synchronous data input for DIR, DA70Y, DAC
30	CLK5 P77/TA3in/INPC14/ OUTC14/ISCLK0/ CLK5/RTP22	DSP_SCK	SO	O	O	O	O	Synchronous clock output for DIR, DA70Y, DAC
31	TXD5 P76/TA3out/INPC13/ OUTC13/ISTXD0/ TXD5	DSP_MOSI	SO	O	O	O	O	Synchronous data output for DIR, DA70Y, DAC
32	P75 P75/TA2in/W/ INPC12/OUTC12/ ISRXD1/RTP21	DIR_N_RST	O	O	O	O	O	DIR reset
33	P74 P74/TA2out/W/ INPC11/OUTC11/ ISCLK1/RTP20	DSP_FMT	O	O	O	O	O	DA70Y full mute output H: Mute
34	P73	232C_MISO	O	O	O	O	O	used to trigger a return from Stop mode (MCUSleep)
35	P72 P72/TA1out/V/CLK2	SEL_CDDA	O	O	O	O	O	CDDA writing route select H: CDDA writing mode, L: Operational mode usually
36	SCL2 P71/TA0in/TB5in/ RXD2/SCL2/STXD2/ INPC17/OUTC17/ OUTC22/ISRXD2/ IEin/RTP03	CEC_SCL	SO	SO	O	O	O	CEC microprocessor, Tuner, HDMI_EQ (SiI9185A) I2C SCL output (100 kHz device) u-com block then +3.3S, 3.3k then Pull up
37	SDA2 P70/TA0out/TXD2/ SDA2/SRXD2/ INPC16/OUTC16/ OUTC20/ISTXD2/ IEout/RTP02	CEC_SDA	SIO	SIO	O	O	O	CEC microprocessor, Tuner, HDMI_EQ (SiI9185A) I2C SDA input (100 kHz device) u-com block then +3.3S, 3.3k then Pull up
38	TxD1 P67/TXD1/SDA1/ SRXD1	232C_MOSI	SO	SO	SO	O	O	RS232C data output Pull up at 100 k-ohms
	TxD1	TXD	SO					E8a, ICP (In-circuit programmer) data output
39	Vcc1 Vcc1	Vcc1	MCU	MCU	MCU	MCU	MCU	Microprocessor power supply
40	RxD1 P66/RXD1/SCL1/ STXD1	232C_MISO	SI	SI	SI	I	I	RS232C data input Pull up at 100 k-ohms
	RxD1	RXD	SI					E8a, ICP (In-circuit programmer) data input
41	Vss Vss	Vss	MCU	MCU	MCU	MCU	MCU	Microprocessor GND
42	P65 P65/CLK1	232C_RTS	SO	SO	SO	O	O	RS232C RTS output
	CLK1	E8a_SCLK	SI					E8a, ICP (In-circuit programmer) clock input Pull up at 100 k-ohms
43	CTS1 P64/CTS1/RTS1/ SS1/OUTC21/ ISCLK2	232C_CTS	SI	SI	SI	I	I	RS232C CTS input Pull down at 100 k-ohms
	RTS1	E8a_BUSY	SO					E8a, ICP (In-circuit programmer) BUSY output
44	SDA0 P63/TXD0/SDA0/ SRXD0/IrDAout	HDMI_SDA	SIO	SIO	O	O	O	HDMI RX/TX, Video Enc/Dec I2C SCL output (400 kHz device) Pull up at HDMI block HDMI RX/TX: 5V tolerant

RX-V465/HTR-6240/
AX-V465

Pin No.	Port Name	Function Name (P.C.B.)	I/O					Detail of Function
			Power On	Stby Thrh	standby	Stby Sleep	MCU Sleep	
45	SCL0 P62/RXD0/SCL0/ STXD0/IrDAin	HDMI_SCL	SIO	SIO	0	0	0	HDMI RX/TX, Video Enc/Dec I2C SDA input/output (400 kHz device) Pull up at HDMI block HDMI RX/TX: 5V tolerant
46	P61	232C_PON	0	0	0	0	0	H: ON, L: OFF
47	P60 P60/CTS0/RTS0/ SS0/RTP00	CEC_INT2	I	I	0	0	0	CEC microprocessor interrupt
48	P137 P137/OUTC27	CEC_N_RST	0	0	0	0	0	CEC microprocessor reset
49	ISCLK2 P136/OUTC21/ ISCLK2	REM_CLK	SO	0	0	0	0	Clock output for remote control code generation No connection
50	P135 P135/OUTC22/ ISRXD2/IEin	HTX_PON	0	0	0	0	0	No use (HDMI_PON common)
51	P134 P134/OUTC20/ ISTXD0/Ieout	REM_OUT						
52	P57 P57/RDY	HRX_N_RST	0	0	0	0	0	HDMI TX reset output L: Reset Pull down at HDMI block
53	P56 P56/ALE	HTX_N_RST	0	0	0	0	0	HDMI TX reset output L: Reset Pull down at HDMI block
54	P55 P55/HOLD	E8a_N_EPM	I	I	I	I	I	E8a writing mode enable input 10 k-ohms pull down
55	P54 P54/HLDA/ALE	HTX_AUSEL	0	0	0	0	0	No use (HDMI Rx GPIO use)
56	P133 P133/OUTC23	HTX_VSEL	0	0	0	0	0	No use (HDMI Rx GPIO use)
57	Vss Vss	Vss	MCU	MCU	MCU	MCU	MCU	Microprocessor GND
58	P132 P132/OUTC26	ABT_N_RST	0	0	0	0	0	Video I/P & Scaler IC reset L: reset VID_PON=L: Low fix
59	Vcc2 Vcc2	Vcc2	MCU	MCU	MCU	MCU	MCU	Microprocessor power supply
60	P131 P131/OUTC25	HDMI_PON	0	0	0	0	0	HDMI power supply ON/OFF control H: ON, L: OFF when V2065 uses CEC microprocessor, HDMI EQ (CXB1442, Sil9185A) Reset may be used
61	P130 P130/OUTC24	VID_PON	0	0	0	0	0	Video power supply ON/OFF control H: ON, L: OFF Configured based on the Pure Direct specification
62	P53	SCPU_N_RST	0	0	0	0	0	
63	P52	SCPU_N_SS	0	0	0	0	0	
64	P51	SCPU_RTS	0	0	0	0	0	
65	P50 P50/WRL/WR	E8a_N_CE	I	I	I	I	I	E8a enable input 10 k-ohms pull up
66	P127 P127	SVID_DET	I	0	0	0	0	S video detection VID_PON=L: Low Fix
67	P126 P126	DVID_N_RST	0	0	0	0	0	Video Enc/Dec reset VID_PON=L: Low Fix
68	P125 P125	OSD_N_CS	CS	0	0	0	0	OSD chip select VID_PON=L: Low Fix
69	P47 P47/SC0/A23	DSP_PON	0	0	0	0	0	DSP power supply ON/OFF control H: ON, L: OFF
70	P46 P46/SC1/A22	SPRY_FA	0	0	0	0	0	Front A speaker relay control H: ON, L: OFF
71	P45 P45/SC2/A21	SPRY_FB	0	0	0	0	0	Front B Speaker relay control H: ON, L: OFF
72	P44 P44/SC3/A20	CPNT_DET	0	0	0	0	0	No use

Pin No.	Port Name	Function Name (P.C.B.)	I/O					Detail of Function
			Power On	Stby Thrh	Standby	Stby Sleep	MCU Sleep	
73	P43 P43/A19	SPRY_C	0	0	0	0	0	Center speaker relay control
74	Vcc2 Vcc2	Vcc2	MCU	MCU	MCU	MCU	MCU	Microprocessor power supply
75	P42 P42/A18	SPRY_S	0	0	0	0	0	Surround speaker relay control
76	Vss Vss	Vss	MCU	MCU	MCU	MCU	MCU	Microprocessor GND
77	P41 P41/A17	VOL_SCK	0	0	0	0	0	Electronic volume Flip-flop synchronous clock output
78	P40 P40/A16	VOL_MOSI	0	0	0	0	0	Electronic volume Flip-flop synchronous data output
79	P37 P37/A15/(D15)	SPRY_SB	0	0	0	0	0	Surround back/Bi-AMP relay control
80	P36	SPRY_Z2	0	0	0	0	0	SPRY_Z and SPRY_FB do not become High at the same time
81	P35	SPRY_Z3	0	0	0	0	0	
82	P34 P34/A12/(D12)	HPRY	0	0	0	0	0	Head phone relay control
83	P33 P33/A11/(D11)	SP_IMP	0	0	0	0	0	Speaker impedance relay control set to 8 ohms: Low (Relay OFF, B voltage High) Set to 6 ohms plus during rising temperature: High (Relay ON, B voltage Low)
84	P32 P32/A10/(D10)	HP_N_DET	1	0	0	0	0	Headphone detection L: Headphone +3.3S pull up
85	P31 P31/A9/(D9)	E2R_N_CS	CS	CS	CS	1	1	EEPROM chip select at 10 k-ohms Pull Up to EEPROM's power
86	P124	MUTE_N_Z3	0	0	0	0	0	
87	P123	MUTE_N_Z2	0	0	0	0	0	
88	P122	HDR_MISO	0	0	0	0	0	
89	P121 P121/CLK6	MUTE_N_SW	0	0	0	0	0	Subwoofer mute control L: Mute
90	P120	HDR_MOSI	0	0	0	0	0	
91	Vcc2 Vcc2	Vcc2	MCU	MCU	MCU	MCU	MCU	Microprocessor power supply
92	P30 P30/A8/(D8)	MUTE_N_SB	0	0	0	0	0	Surround back/Bi-AMP/Zone2 mute control L: Mute
93	Vss Vss	Vss	MCU	MCU	MCU	MCU	MCU	Microprocessor GND
94	P27 P27/A7/(D7)/AN27	TUN_N_TUND	1	0	0	0	0	FM/AM tuner TUNED input +3.3S to 47k then Pull Up
95	P26 P26/A6/(D6)/AN26	TUN_N_ST	1	0	0	0	0	FM/AM tuner STEREO detection input +3.3S to 47k then Pull Up
96	P25 P25/A5/(D5)/AN25	+3.3S_PON	0	0	0	0	1	+3.3S power supply ON/OFF control H: ON, L: OFF at Standby Sleep, becomes L [to avoid unnecessary power consumption (Mute, Pull Up)] Input (HiZ) then mechanically +3.3S power switches on (to function Mute, when power down is detected)
97	P24 P24/A4/(D4)/AN24	PRY	0	0	0	0	0	Power relay ON/OFF control H: ON, L: OFF
98	P23 P23/A3/(D3)/AN23	L_PRT	1	1	0	0	0	Overcurrent protection detection
99	P22 P22/A2/(D2)/AN22	MUTE_N_S	0	0	0	0	0	Surround mute control L: Mute
100	P21 P21/A1/(D1)/AN21	MUTE_N_C	0	0	0	0	0	Center mute control L: Mute
101	P20 P20/A0/(D0)/AN20	MUTE_N_F	0	0	0	0	0	Front (Headphone is contained) mute control L: Mute
102	INT5 P17/D15/INT5	ACPWR_DET	IRQ	IRQ	IRQ	IRQ	0	AC power detection L: Power down
103	INT4 P16/D14/INT4	PSW_DET	IRQ	IRQ	IRQ	IRQ	0	Main/Zone/Input key interrupt KEY1 port distinguishes the pressed keys

Pin No.	Port Name	Function Name (P.C.B.)	I/O					Detail of Function
			Power On	Stby Thrh	standby	Stby Sleep	MCU Sleep	
104	INT3 P15/D13/INT3	REM_IN	IRQ	IRQ	IRQ	IRQ	0	Remote control pulse input
105	P14	XM_PON	0	0	0	0	0	
106	P13 P13/D11	DOCK_PON	0	0	0	0	0	DOCK power supply ON/OFF control H: ON, L: OFF
107	P12 P12/D10	IOXV_N_CS	CS	0	0	0	0	IO extended IC (for video) chip select
108	P11 P11/D9	IOXV_N_RST	0	0	0	0	0	IO extended IC (for video) reset
109	P10 P10/D8	PD_LED	0	0	0	0	0	Pure Direct LED ON/OFF control H: ON, L: OFF
110	P07 P07/D7/AN07	FLD_N_RST	0	0	0	0	0	FL driver reset
111	P06	PRG_RA	0	0	0	0	0	
112	P05	PRG_RB	0	0	0	0	0	
113	P04 P04/D4/AN04	MIC_N_DET	I	0	0	0	0	MIC detection L: MIC
114	P114 P114	IPD_APDET	I	I	I	I	I	iPod accessory power detection while iPod boots up (about two seconds) it is set at Low after the boot, it identifies to prevent pulling of iPod's High output and microcomputer's Low Fix output, switch to constant input
115	P113	VOL_RA	I	0	0	0	0	Volume rotary A
116	P112	SR_MISO	0	0	0	0	0	to prevent pulling of SIRIUS tuner's High output and microcomputer's Low Fix output, switch to constant input
117	P111/INPC11/ OUTC11/ISCLK1	VOL_RB	I	0	0	0	0	Volume rotary B
118	P110	SR_MOSI	0	0	0	0	0	
119	P03	SR_PON	0	0	0	0	0	
120	P02 P02/D2/AN02	SEL_PD	0	0	0	0	0	DSP Pure Direct route select H: Pure Direct ON
121	P01 P01/D1/AN01	A D C _ N _ PDWN	0	0	0	0	0	ADC power down L: Power down
122	P00 P00/D0/AN00	FLD_N_CS	CS	0	0	0	0	FL driver chip select
123	P157	L3_DET	0	0	0	0	0	
124	AN156 P156/AN156/CLK6	THM	AD	AD	0	0	0	Temperature detection
125	AN155 P155/AN155/RXD6	AMP_OLV	AD	AD	0	0	0	Power AMP output level detection
126	AN154 P154/AN154/TXD6	DC_PRT	AD	AD	0	0	0	Power AMP DC detection
127	AN153 P153/AN153/CTS5/ RTS5	MODEL	AD	AD	0	0	0	Destination discrimination by AD value When AD is taken in at power on, there is 1m sec waiting time after AD input port setting
128	ISRXD0 P152/AN152/ ISRXD0/RXD5	E2R_MISO	SI	SI	SI	0	0	Synchronous data input for EEPROM
129	ISCLK0 P151/AN151/ISCLK0/ CLK5	FLD_SCK	SO	SO	SO	0	0	FL driver, OSD, IO extended IC (Video), Series 1k-ohms go into Synchronous clock output for EEPROM FL driver
130	Vss Vss	Vss	MCU	MCU	MCU	MCU	MCU	Microprocessor GND
131	ISTXD0 P150/AN150/ISTXD0/ TXD5	FLD_MOSI	SO	SO	SO	0	0	FL driver, OSD, IO extended IC (Video), Series 1k-ohms go into Synchronous data output for EEPROM FL driver
132	Vcc1 Vcc1	Vcc1	MCU	MCU	MCU	MCU	MCU	Microprocessor power supply
133	AN7 P107/AN7/KI3/RTP33	KEY1	AD	AD	AD	I	0	duing PSW_DET interruption, distinguishes the used keys which are switched to AD
134	AN6 P106/AN6/KI2/RTP32	KEY2	AD	AD	AD	I	0	duing PSW_DET interruption, distinguishes the used keys which are switched to AD

Pin No.	Port Name	Function Name (P.C.B.)	I/O					Detail of Function
			Power On	Stby Thrh	Standby	Stby Sleep	MCU Sleep	
135	AN5 P105/AN5/K11/RTP31	PS1_PRT	AD	AD	○	○	○	PS protection detection 1
136	AN4 P104/AN4/K10/RTP30	PS2_PRT	AD	AD	○	○	○	PS protection detection 2
137	P103	ISEL_RA	○	○	○	○	○	
138	P102	ISEL_RB	○	○	○	○	○	
139	AN1 P101/AN1/RTP11	DEST	AD	AD	AD	○	○	AD destination discrimination Data is taken in when resetting is cancelled
140	AVss AVss	AVss	MCU	MCU	MCU	MCU	MCU	Microprocessor GND
141	AN0 P100/AN0/RTP10	DOCK_TYPE	AD	AD	AD	I	○	DOCK discriminate identifies the connected DOCK type, then switches the action During IPD_DET interruption, switches to AD, make a distinction based on post-10ms A/D value Make a distinction from IPD_DET's Low edge through post-10ms A/D value
142	Vref Vref	VREF	MCU	MCU	MCU	MCU	MCU	Microprocessor power supply
143	AVcc AVcc	AVcc	MCU	MCU	MCU	MCU	MCU	Microprocessor power supply
144	RXD4 P97/ADTRG/RXD4/ SCL4/STXD4	IPD_MISO	SI	I	I	I	○	Asynchronous data input for iPod to prevent pulling of iPod's High output and microcomputer's Low Fix output, input setup

Key detection for A/D port

Key input (A/D) pull-up resistance 10 k-ohms

Ohm	0	+ 1.0k	+ 1.0k	+ 1.5k	+ 1.5k	+ 2.2k	+ 3.3k	+ 4.7k	+ 22.0k	+ 33.0k
V	0 - 0.15	0.15 - 0.42	0.43 - 0.70	0.71 - 0.97	0.98 - 1.24	1.25 - 1.53	1.54 - 1.84	1.84 - 2.1	2.34 - 2.55	2.55 - 2.97
A/D value (3.3 V=255)	0 - 11	12 - 32	33 - 54	55 - 75	76 - 95	96 - 118	119 - 142	143 - 162	161 - 197	198 - 229
KEY1 (133 pin)	SCENE RADIO	SCENE OD	SCENE TV	SCENE BD/DVD	-	-	PROGRAM >	PROGRAM <	STANDBY/ ON	STONE CONTROL

Ohm	0	+ 1.0k	+ 1.0k	+ 1.5k	+ 1.8k	+ 2.2k	+ 3.3k	+ 4.7k	+ 6.8k	+ 10.0k	+ 22.0k	+ 68.0k
V	0 - 0.15	0.15 - 0.42	0.43 - 0.70	0.71 - 0.99	1.0 - 1.27	1.28 - 1.56	1.57 - 1.86	1.86 - 2.14	2.14 - 2.4	2.4 - 2.65	2.66 - 2.91	2.92 - 3.17
A/D value (3.3 V=255)	0 - 11	12 - 32	33 - 54	55 - 77	78 - 98	99 - 120	121 - 143	144 - 165	166 - 185	186 - 205	206 - 225	226 - 245
KEY2 (134 pin)	DIRECT	STRAIGHT	INFO	MEMORY	PRESET <	PRESET >	CATEGORY < FM	CATEGORY > AM	TUNING CH <	TUNING CH >	INPUT <	INPUT >

Destination detection for A/D port

Destination input (A/D) pull-up resistance 10 k-ohms

Ohm (R3809 VIDEO P.C.B.)	0	1.2k	2.7k	4.7k	6.8k	10.0k	15.0k	47.0k	100.0k
V	0 - 0.2	0.2 - 0.6	0.6 - 0.9	0.9 - 1.2	1.2 - 1.5	1.5 - 1.8	1.8 - 2.3	2.4 - 2.9	2.9 - 3.2
A/D value (3.3 V=255)	0 - 15	15 - 46	46 - 69	69 - 92	92 - 115	115 - 139	139 - 177	185 - 224	224 - 247
DEST (139 pin)	J	U	C	R	T	K	A	B, G, E, F	L

Model detection for A/D port

Model input (A/D) pull-up resistance 10 k-ohms

Ohm	0	1.0k
V	0 - 0.2	0.2 - 0.5
A/D value (3.3 V=255)	0 - 10	18 - 28
MODEL (127 pin)	RX-V465/ AX-V465	HTR-6240

PIN CONNECTION DIAGRAMS

• ICs

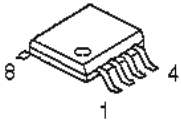
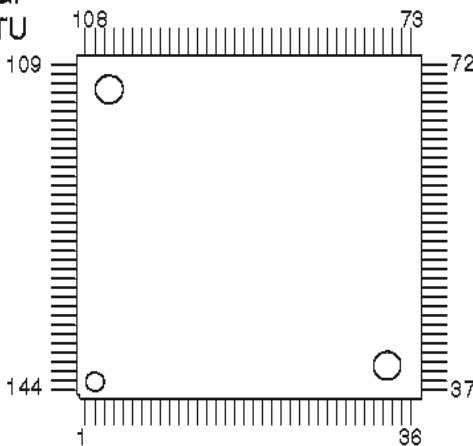
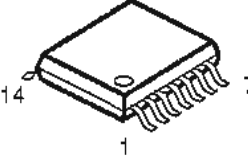
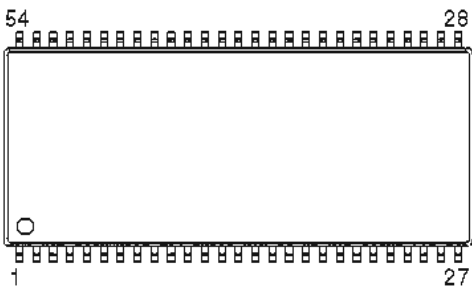
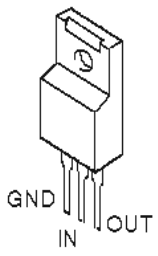
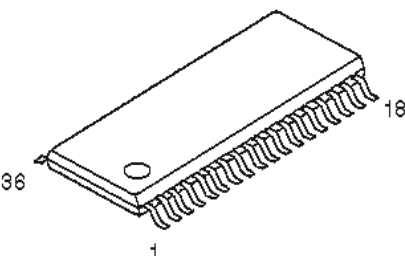
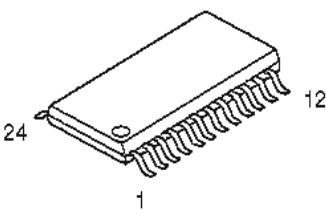
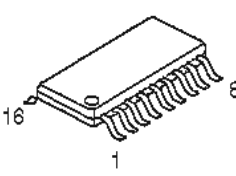
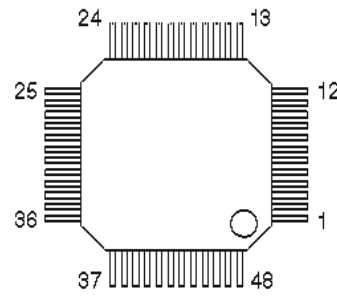
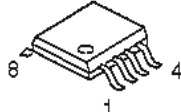
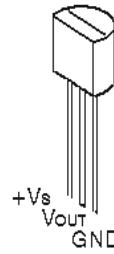
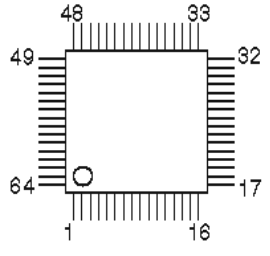
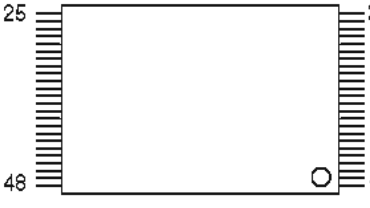
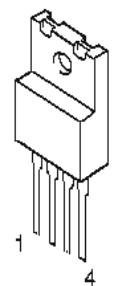
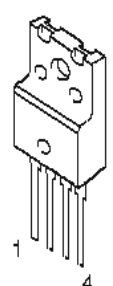
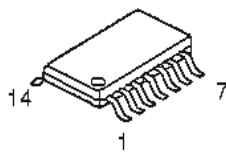
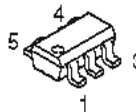
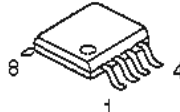
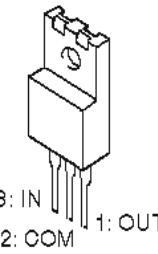
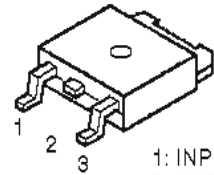
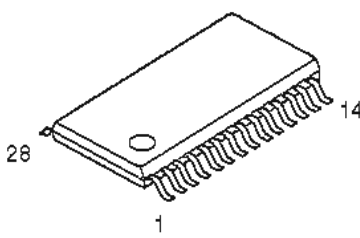
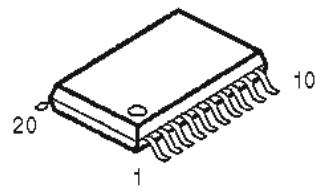
<p>BD9323EFJ-E2</p> 	<p>D70YE101BRFP266 M30878JBGP SI19233ACTU</p> 	<p>FHP3350IM14X</p> 	<p>K4S641632N-LC60000</p> 	
<p>KIA7912PI</p> 	<p>LA73050-TLM-E</p> 	<p>LC709004A-TLM-E</p> 	<p>LC72725KM-UY-TLM-E</p> 	
<p>LC89058WD-E</p> 	<p>LE25LA322M-TLM-E</p> 	<p>LM19CIZ/LF</p> 	<p>M66003-0131FP-R</p> 	<p>MX29LV160DBTI-70G</p> 
<p>NJM2388F05</p>  <p>1. VIN 2. Vout 3. GND 4. ON/OFF CONTROL</p>	<p>NJM2396F05</p>  <p>1. IN 2. Vout 3. GND 4. ON/OFF CONTROL</p>	<p>NJM2581M</p> 	<p>NJM2867F3-05</p> 	<p>NJM4565M NJM4565M (TE1)</p> 
<p>NJM7812FA</p>  <p>3: IN 2: COM 1: OUT</p>	<p>NJM78M05DL1A (TE1)</p>  <p>1: INPUT 2: GND 3: OUTPUT</p>	<p>PCM1680DBQR</p> 	<p>PCM1803DBR</p> 	

• Diodes

1N4002S 1SS133 1SS176 1SS270A		1SS355		DB105		KDS160-RTK	
HT18G		MAZ8033GHL 3.4V MAZ8043GHL 4.4V MAZ8091GML 9.1V		MTZJ10B MTZJ15B MTZJ22C MTZJ3.3B MTZJ39D MTZJ5.1B MTZJ6.8C		P6KE200ARL	
RB051L-40		RB501V-40 UDZ5.1B		RS203M-B-C-J80		SG10SC4M	
							TS6F03G 6.0A 200V

• Transistors

2N5401C-A1/P 2SA1015-Y		2N5551C-AT		2SA1576A		2SB1274		2SC1740S		2SC1815 Y TP 2SC1815 Y TP
2SC2412K		2SC4081 T106		2SD1938F		DTA114EKA DTA144EKA DTC114EKA DTC144EKA		1:GND 2:IN 3:OUT	KRA104S-RTK KRC102S-RTK	
KTA1046-Y-U/P		KTC3875S				MCH6336-TL-E				

R1172H501D-T1-F		R1172S121D-E2-F		R2A15220FP		SN74LVC245APWR	
STK433-130-E		STK433-330-E		SI9134CTU			
TC74HC4051AFEL		TC74HC4053AF		TC74VHC157FT		TC74VHC108AFT TC74VHC04FT	
TL431ACLPR		TOP254PN				TC7SH08FU	

BLOCK DIAGRAMS

ANALOG AUDIO Section Block Diagram

MAIN • See page 117, 118 →
SCHEMATIC DIAGRAM

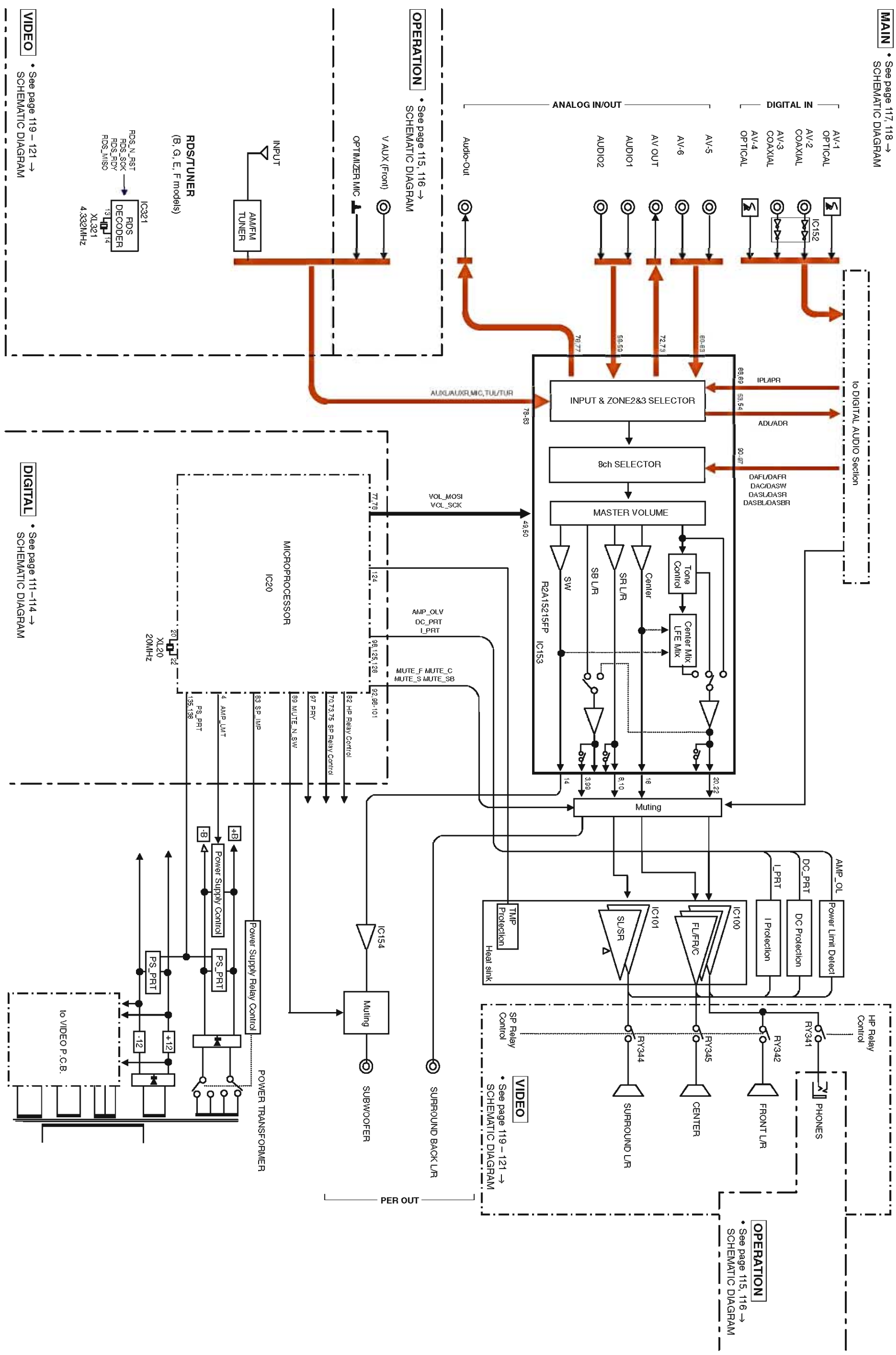

OPERATION • See page 115, 116 →
SCHEMATIC DIAGRAM

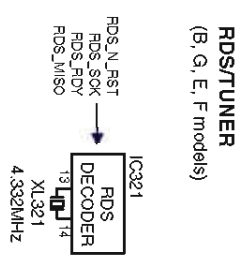

VIDEO • See page 119 - 121 →
SCHEMATIC DIAGRAM

DIGITAL • See page 111 - 114 →
SCHEMATIC DIAGRAM

DIGITAL AUDIO Section Block Diagram

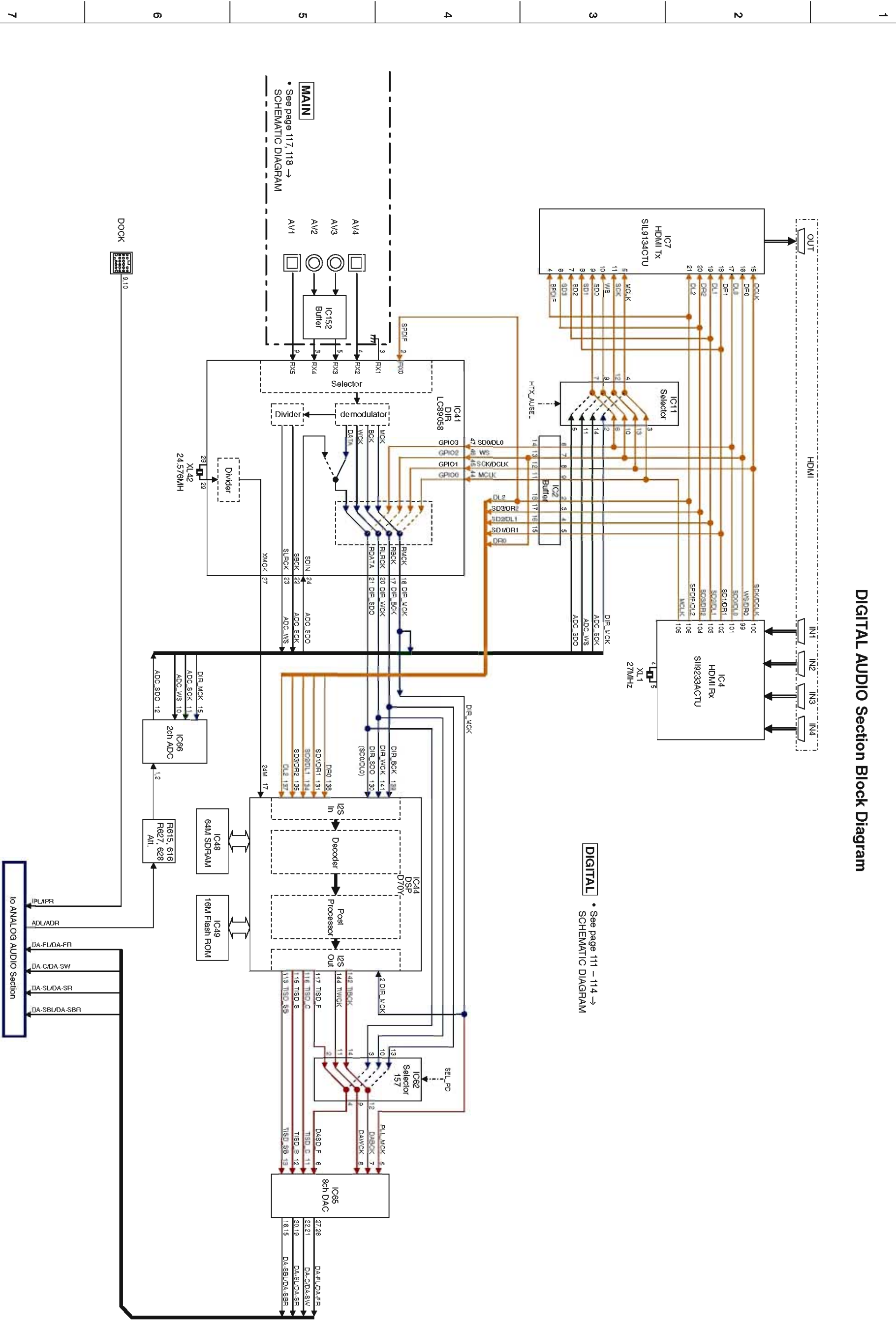

VIDEO Section Block Diagram

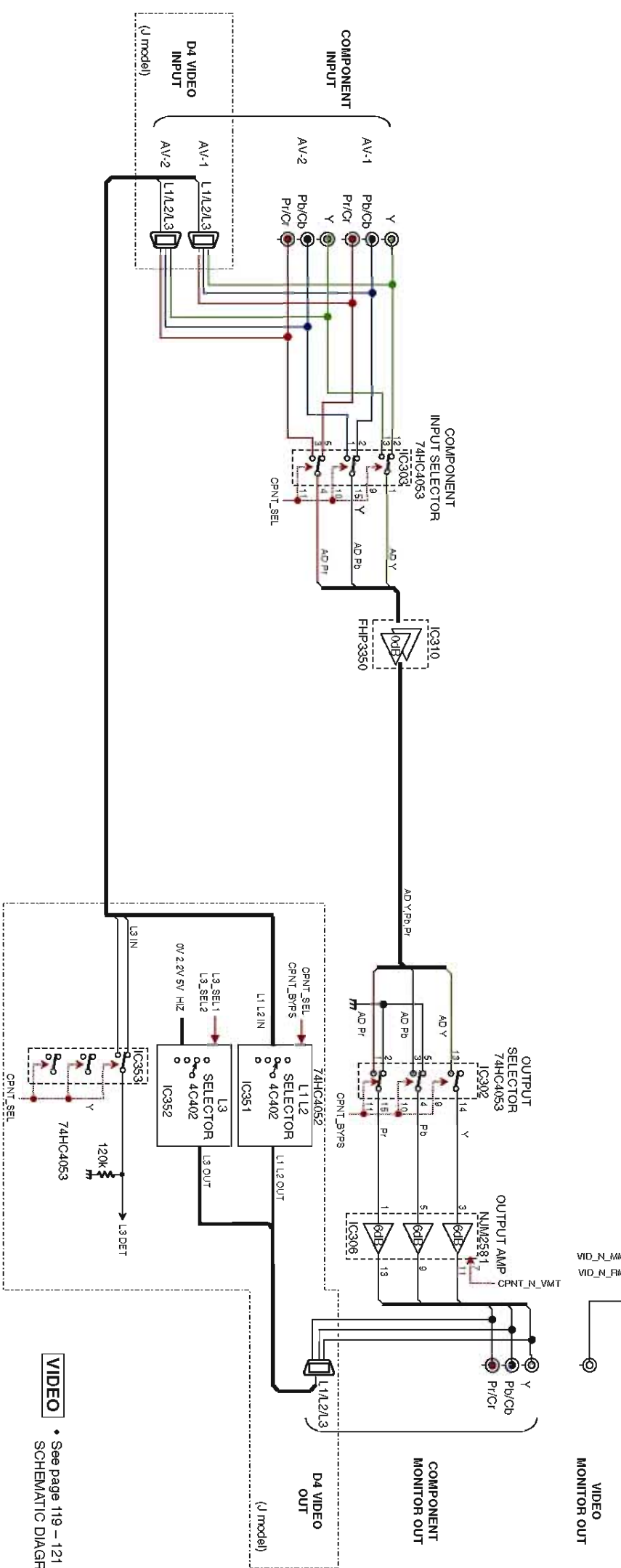
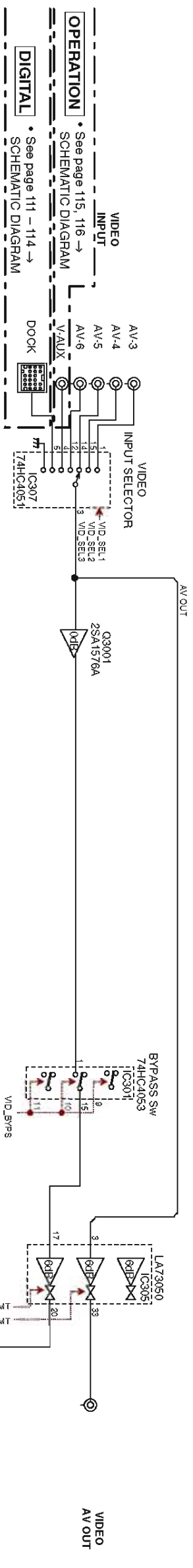
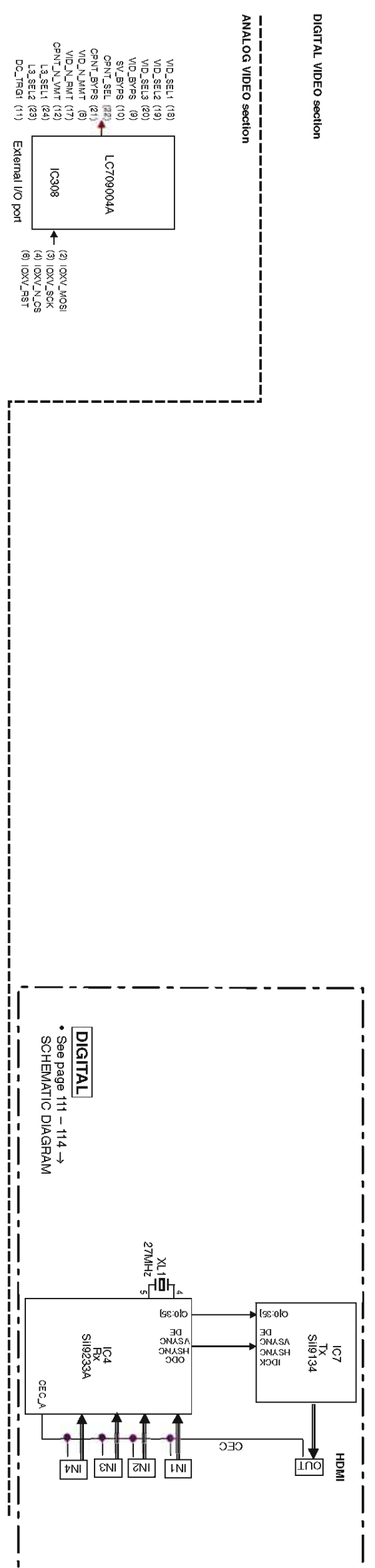

VIDEO • See page 119 – 121 → SCHEMATIC DIAGRAM

Power Supply Section Block Diagram

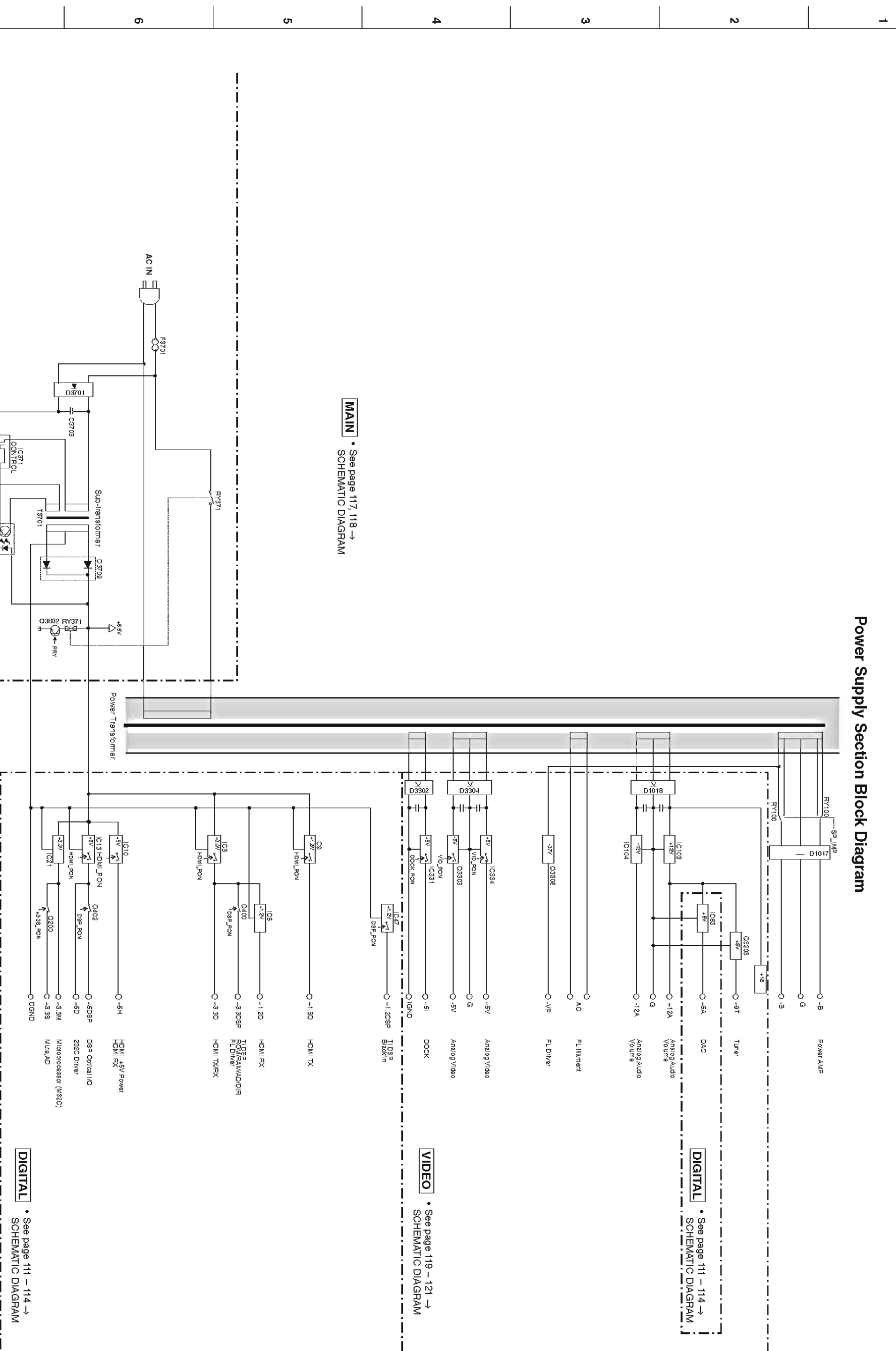

MAIN • See page 117, 118 →
SCHEMATIC DIAGRAM

DIGITAL • See page 111 - 114 →
SCHEMATIC DIAGRAM

VIDEO • See page 119 - 121 →
SCHEMATIC DIAGRAM

DIGITAL • See page 111 - 114 →
SCHEMATIC DIAGRAM

VIDEO • See page 119 - 121 →
SCHEMATIC DIAGRAM

PRINTED CIRCUIT BOARDS

DIGITAL P.C.B. (Side A)

No replacement part available.
 予-ヒ部品供給なし

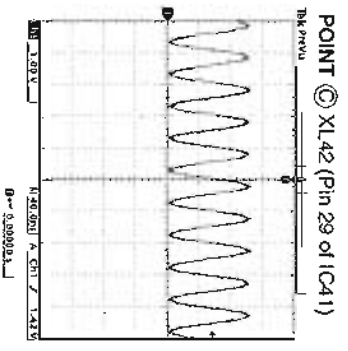
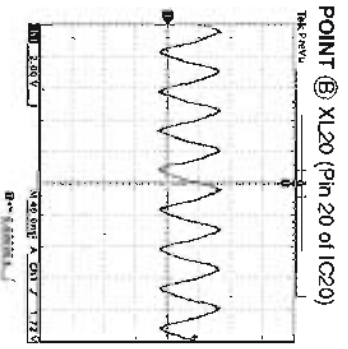
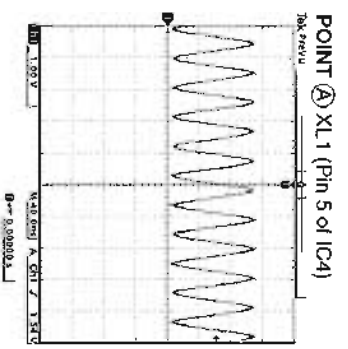
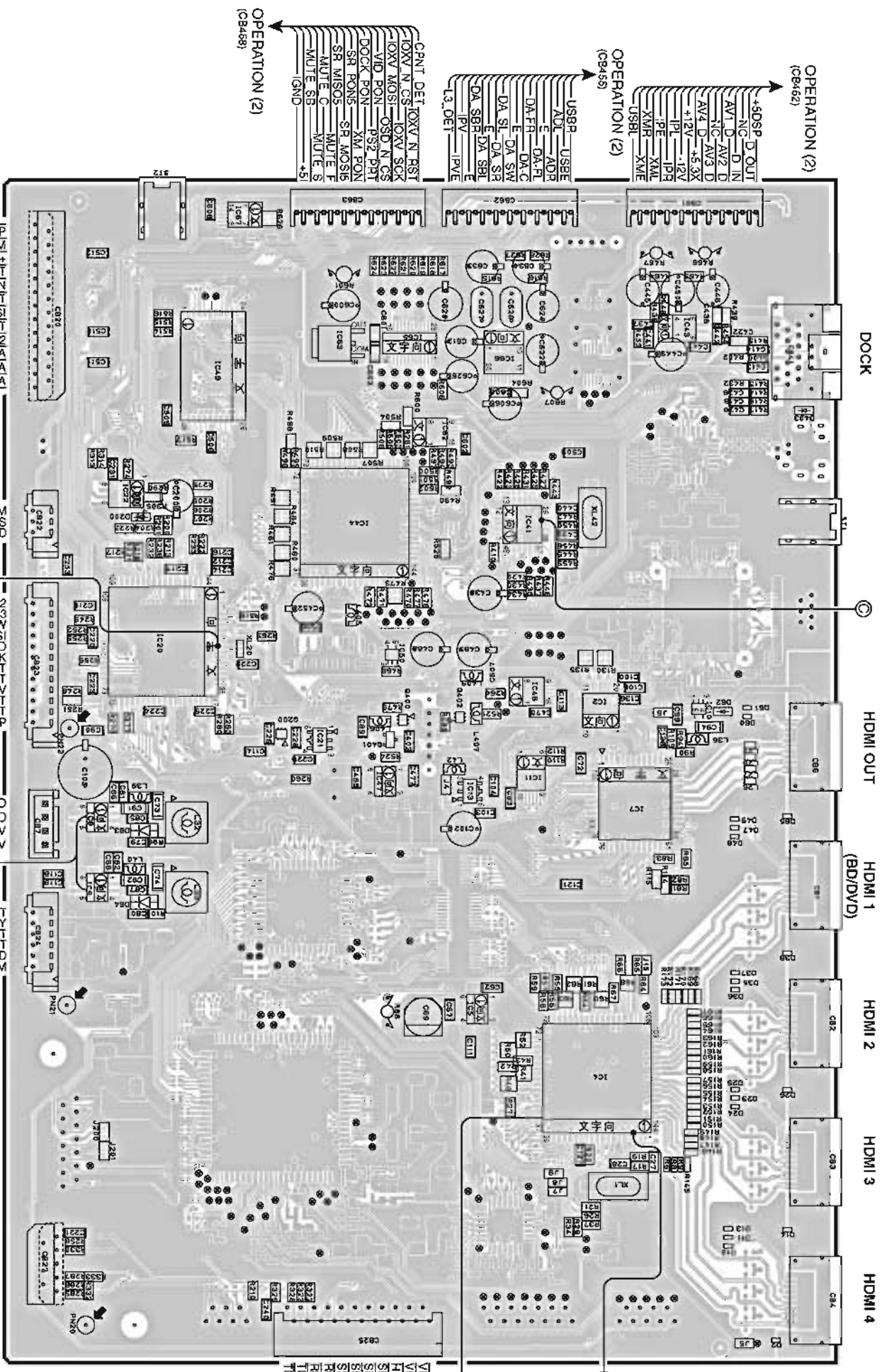

No replacement part available.
 予-ヒ部品供給なし

- VE
- HP, N, DET
- SP, RY, Z3
- SP, RY, S9
- SP, RY, S
- SP, RY, FD
- ROS, HDV
- ROS, MISO
- TUN, N, ST
- TUN, SW, HDR, MOSI
- TUN, SW, HDR, MISO
- AD, CVBS
- OSO
- PST, PRT
- HP, N, DET
- SP, RY, Z3
- SP, RY, S9
- SP, RY, S
- SP, RY, FD
- ROS, HDV
- ROS, MISO
- TUN, N, ST
- TUN, SW, HDR, MOSI
- TUN, SW, HDR, MISO

Semiconductor Location

Ref No.	Location	Ref No.	Location
D2	G3	IC5	F4
D11	G3	IC7	E3
D12	G3	IC8	E6
D13	G3	IC9	E6
D14	G3	IC10	D3
D23	F3	IC11	E4
D24	F3	IC13	E4
D25	F3	IC20	D6
D26	F3	IC21	D5
D35	F3	IC22	C6
D36	F3	IC41	C4
D37	F3	IC43	B3
D38	E3	IC44	C5
D47	E3	IC46	D4
D48	E3	IC47	E5
D49	E3	IC49	C5
D60	D3	IC50	D5
D61	D3	IC62	C4
D62	D3	IC63	C5
D63	E6	IC65	C5
D64	E6	IC66	C4
D65	E3	IC67	B5
D200	C6	Q200	D5
D403	C3	Q400	D5
IC2	D4	Q401	D5
IC4	F4	Q402	D4

No replacement part available.
 予-ヒ部品供給なし

- HO LED
- +3.3DSP
- +5DSP
- DGND
- RM+
- RM-
- MIC N DET
- REM IN
- PD LDE
- FLD N RST
- FLD N CS
- FLD MOSI
- REM OUT
- KEY1
- KEY2
- DGND
- PRG RA
- ISEL RA
- ISEL RB
- VOL RA
- VOL RB

No replacement part available.
 予-ヒ部品供給なし

- MUTE
- MUTE
- MUTE
- VOL
- VOL
- VOL
- DC
- PRT
- AMP
- OLV
- AMP
- LMT
- PS1
- PRT
- SP
- IMP
- DGND
- DGND
- +5.5V
- +5.5V
- +5.5V

No replacement part available.
 予-ヒ部品供給なし

- D5ST
- PRT
- /RESET
- ACPWR
- DET
- DGND
- +3.3M

Writing port

A

B

C

D

E

F

G

H

I

J

DIGITAL P.C.B. (Side B)

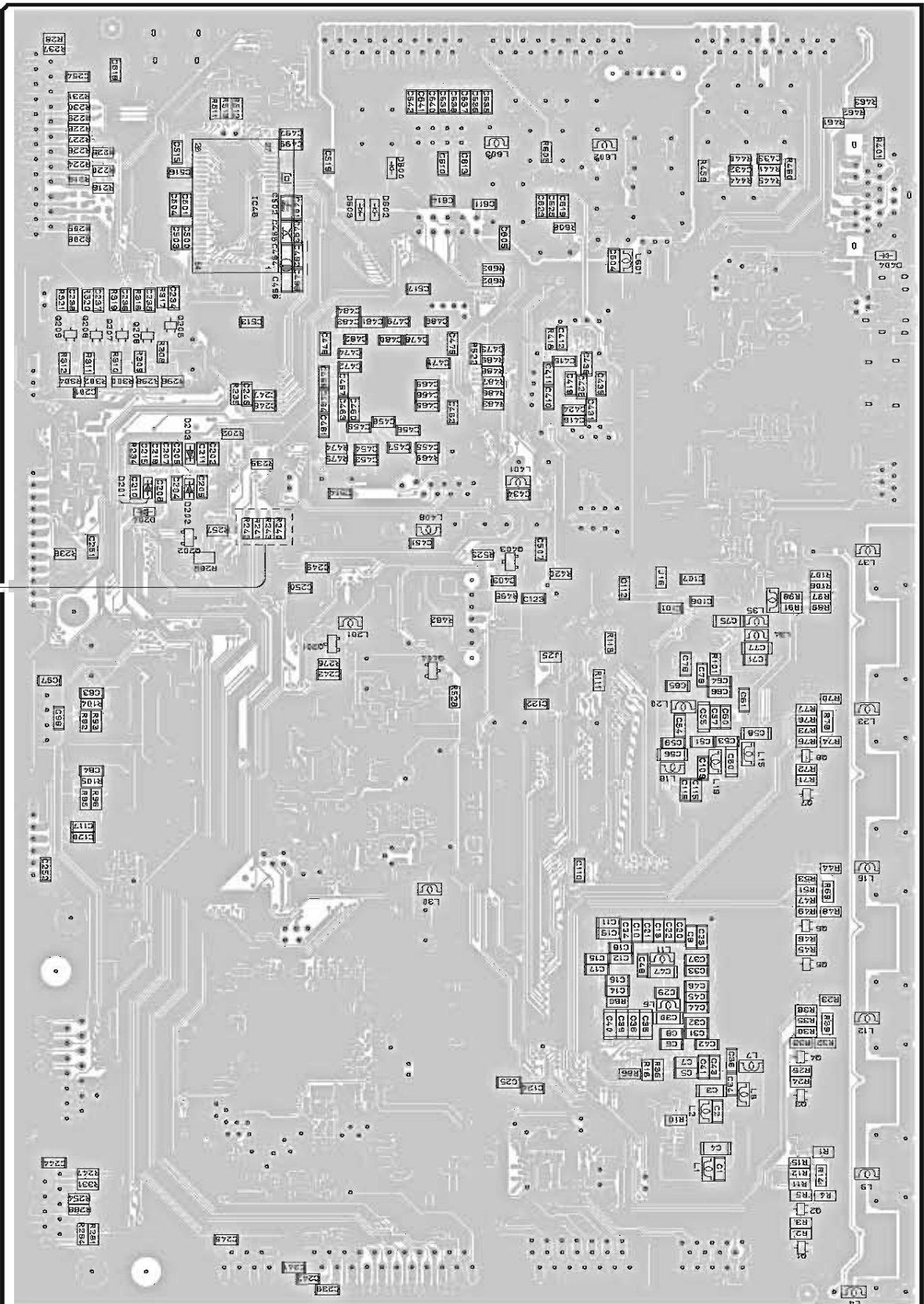

R, G, E, F Models

• Semiconductor Location

Ref No.	Location
D201	D6
D202	D6
D203	D6
D204	D6
D404	C3
D600	C5
D602	C5
D603	C5
IC48	C5
Q1	G3
Q2	G3
Q3	G3
Q4	F3
Q1	F3
Q2	F3
Q3	E3
Q4	E3
Q201	E5
Q202	D6
Q205	C6
Q206	C6
Q207	C6
Q208	C6
Q209	C6
Q403	D4
Q404	E5

7

6

5

4

3

2

1

OPERATION (1) P.C.B. (Side A)

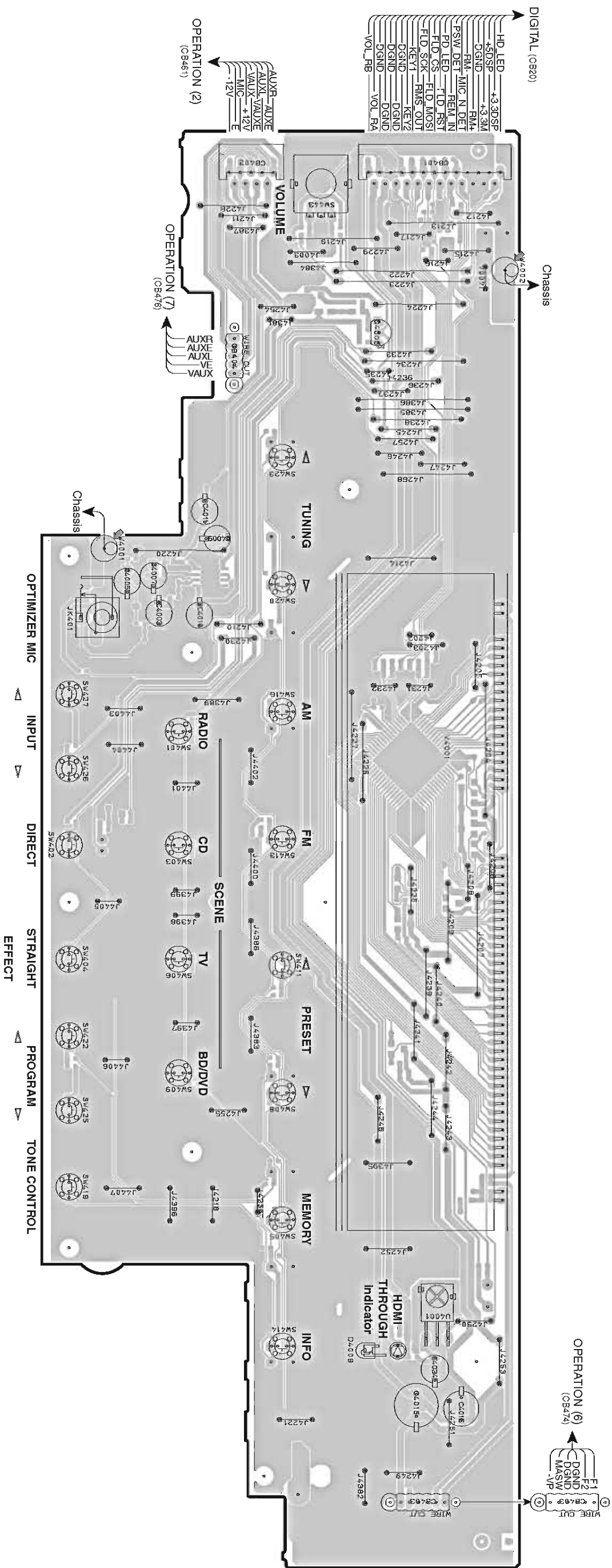

• Semiconductor Location

Ref No.	Location
D4009	I3
Q4005	C3

OPERATION (1) P.C.B. (Side B)

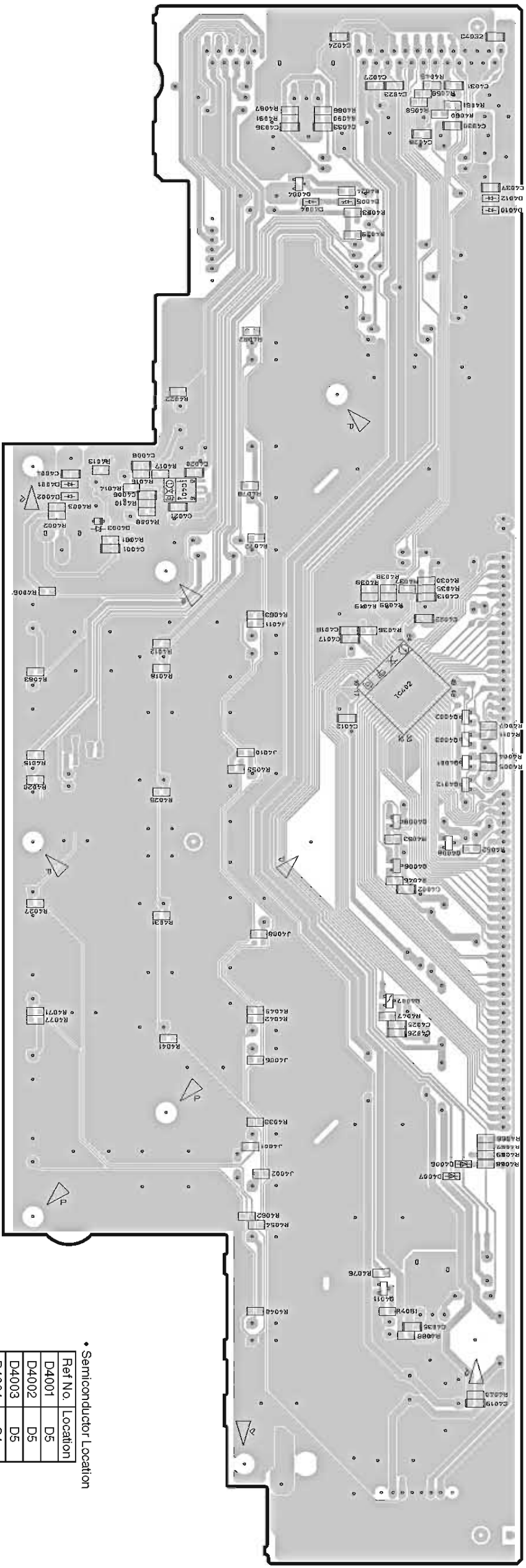

• Semiconductor Location

Ref No.	Location
D4001	D5
D4002	D5
D4003	D5
D4004	C4
D4005	C4
D4006	H3
D4007	H3
D4010	C3
D4012	C3
IC401	D4
IC402	E3
Q4001	F3
Q4002	E3
Q4003	F3
Q4004	C4
Q4006	F3
Q4007	G3
Q4008	F3
Q4009	F3
Q4011	I3
Q4012	F3

OPERATION (2) P.C.B. (Side A)

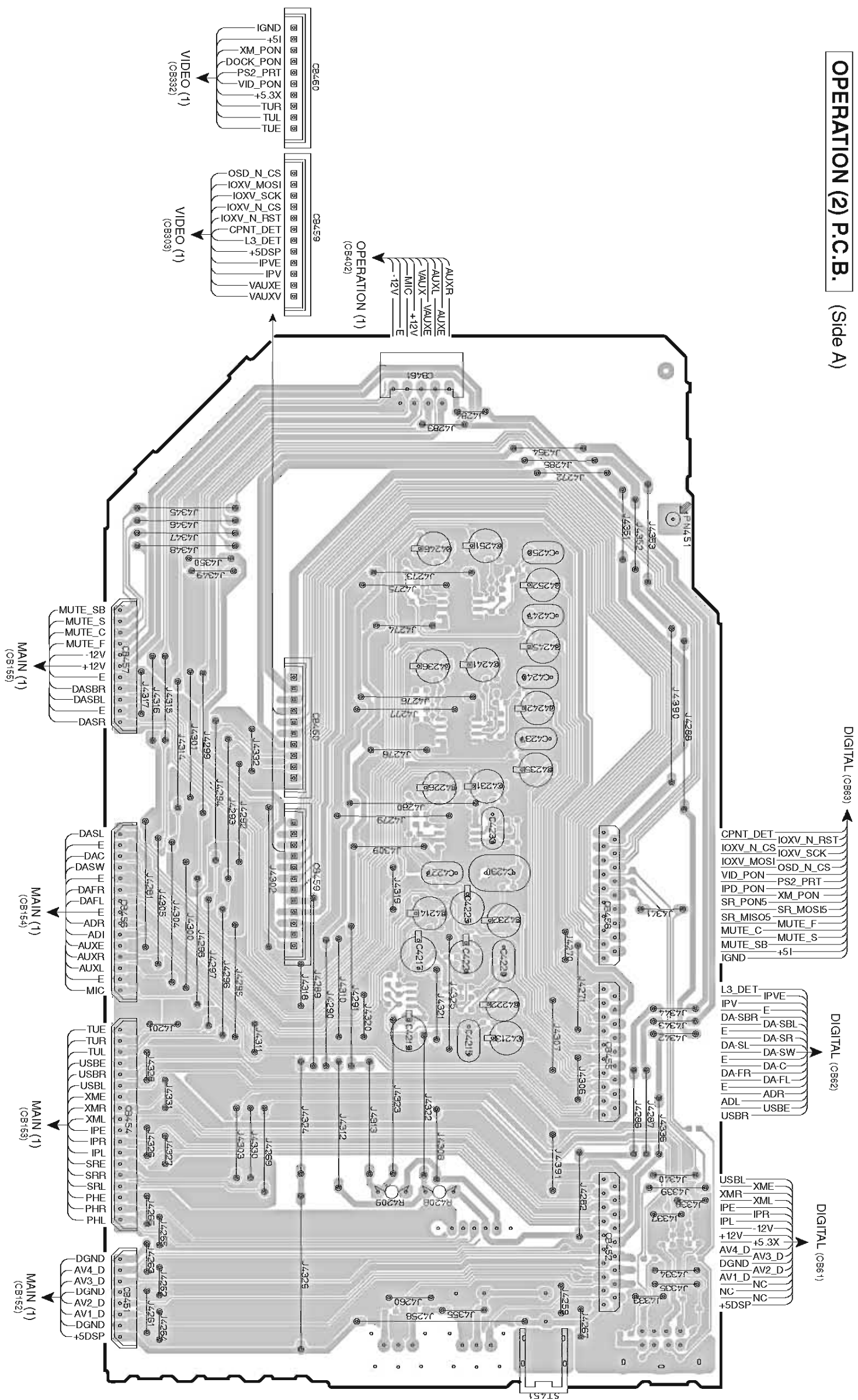

OPERATION (2) P.C.B. (Side B)

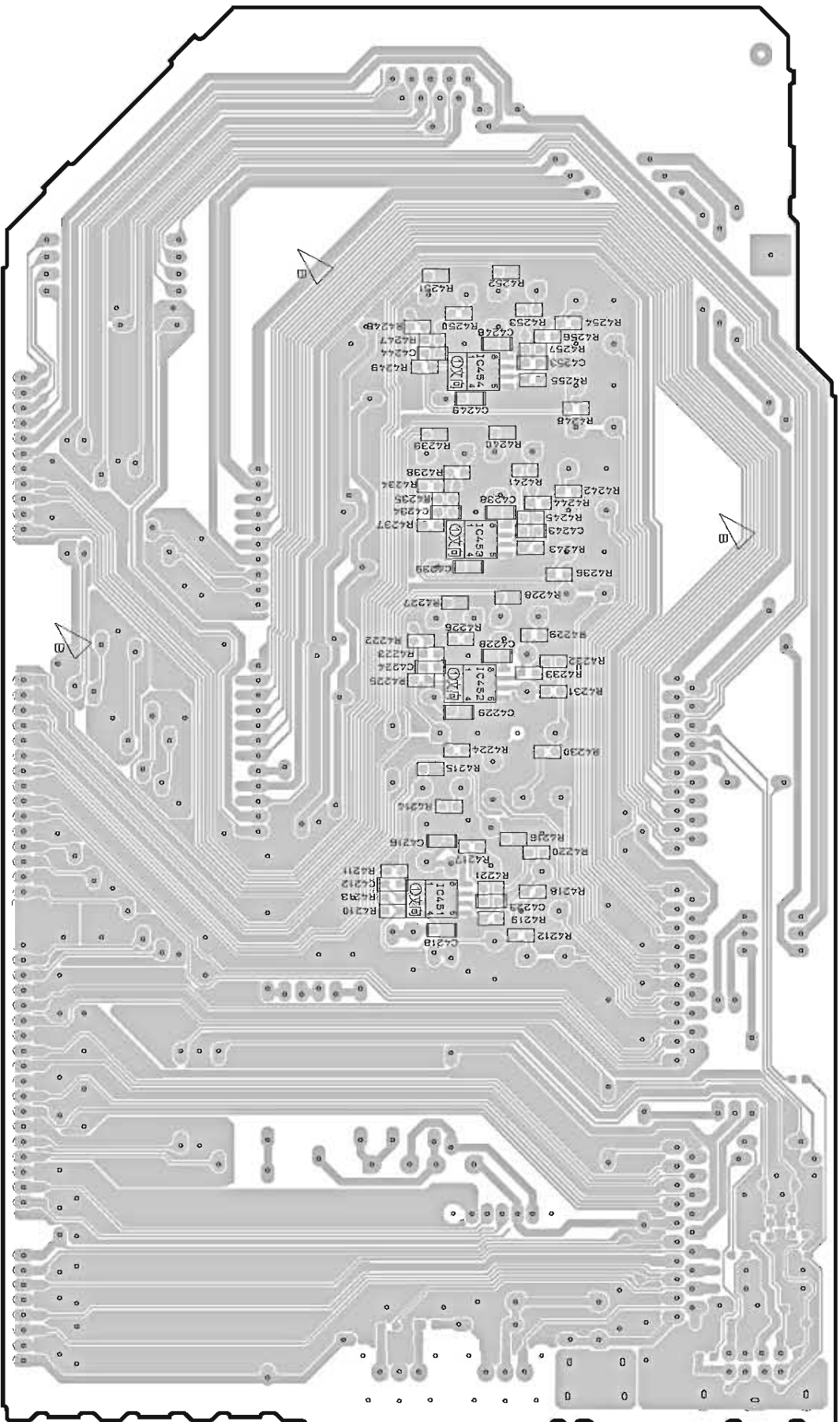

• Semiconductor Location

Ref No.	Location
IC451	F4
IC452	E4
IC453	E4
IC454	D4

A

B

C

D

E

F

G

H

I

J

1

OPERATION (3) P.C.B. (Side B)

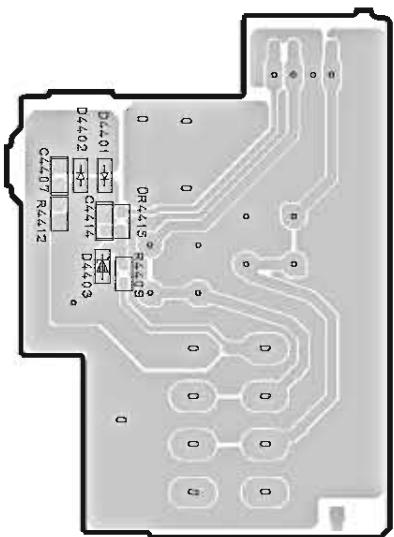

OPERATION (6) P.C.B. (Side B)

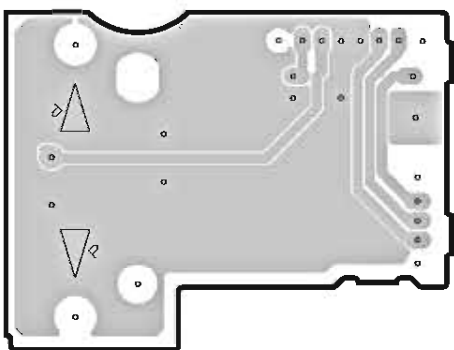

OPERATION (7) P.C.B. (Side B)

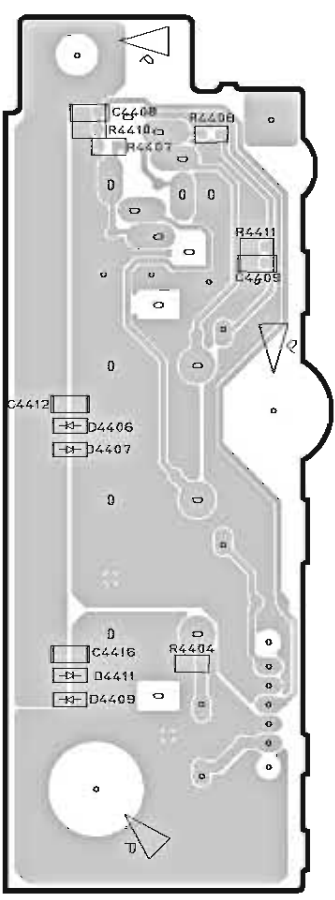

OPERATION (10) P.C.B. (Side B)

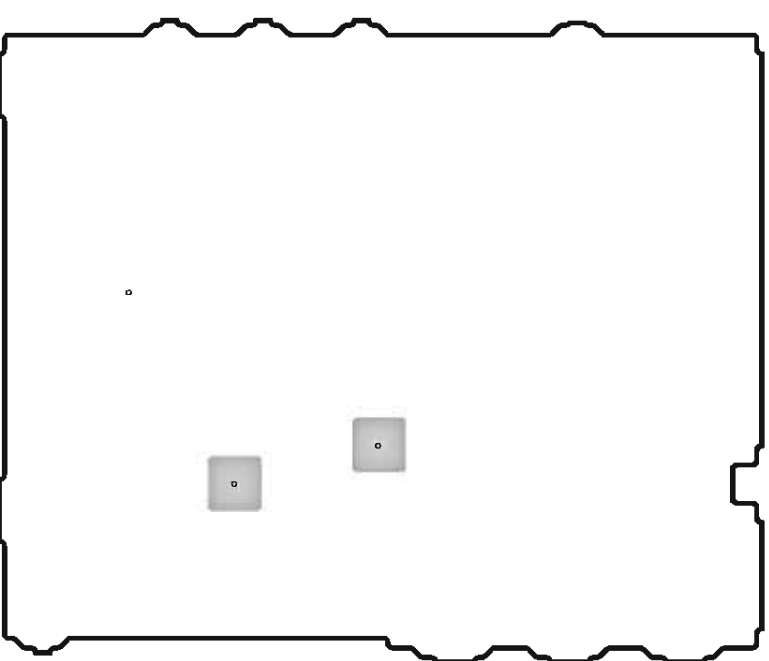

• Semiconductor Location

Ref No.	Location
D4401	B3
D4402	B3
D4403	B3
D4406	H3
D4407	H3
D4409	I3
D4411	I3

1

2

3

4

5

6

7

MAIN (1) P.C.B. (Side A)

— AV1 — AV2 — AV3 — AV4 — AV5 — AV6 — AV — AUDIO1 — AUDIO2 —
OPTICAL COAXIAL OPTICAL (TV)
COAXIAL OPTICAL (CD)

— AUDIO —
OUT

— PRE OUT —
SURROUND BACK SUBWOOFER

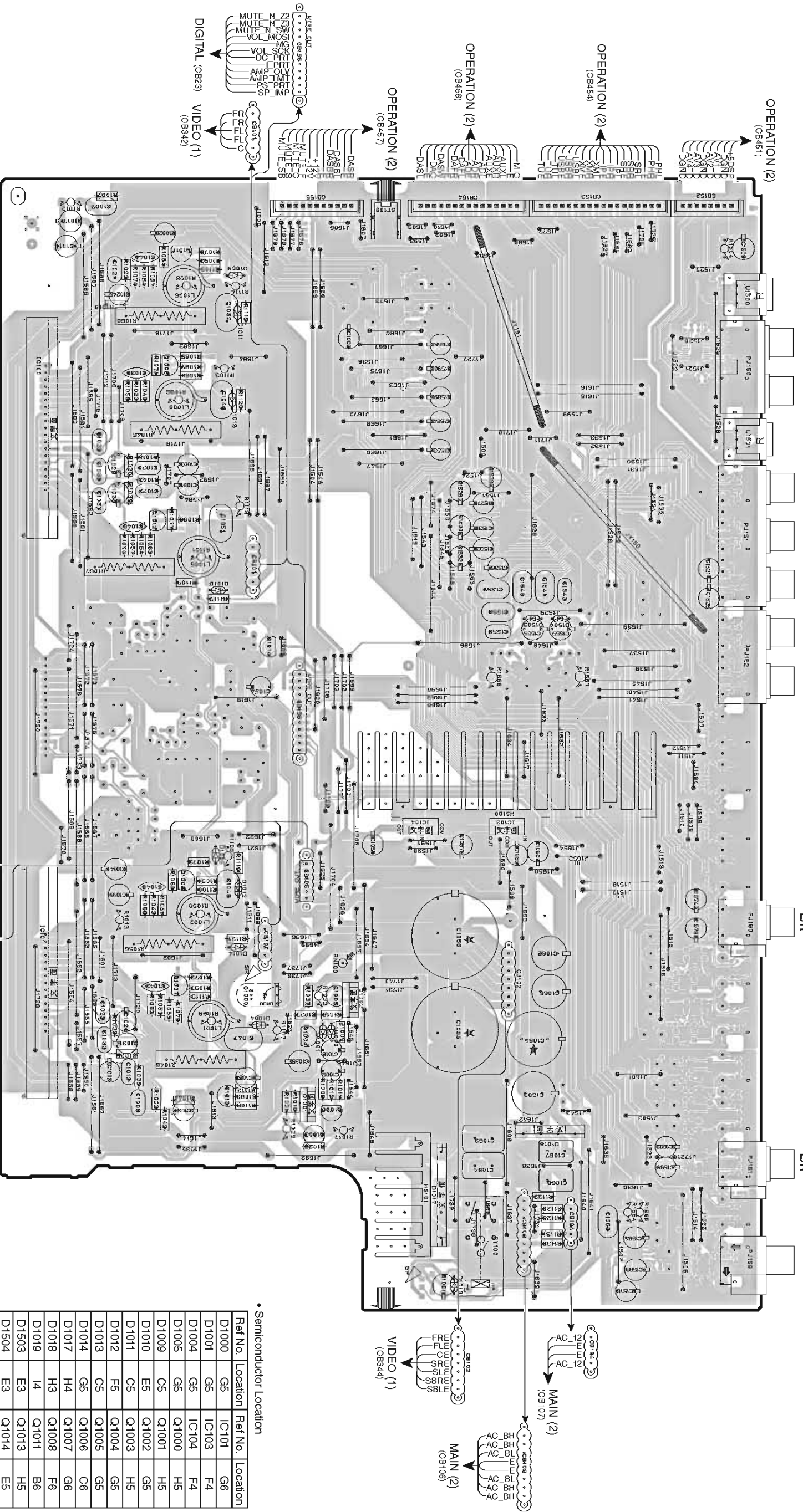

• Semiconductor Location

Ref No.	Location	Ref No.	Location
D1000	G5	IC101	G6
D1001	G5	IC103	F4
D1004	G5	IC104	F4
D1005	G5	Q1000	H5
D1009	C5	Q1001	H5
D1010	E5	Q1002	G5
D1011	C5	Q1003	H5
D1012	F5	Q1004	G5
D1013	C5	Q1005	G5
D1014	G5	Q1006	C6
D1017	H4	Q1007	G6
D1018	H3	Q1008	F6
D1019	I4	Q1011	B6
D1503	E3	Q1013	H5
D1504	E3	Q1014	E5
IC100	C6		

A

B

C

D

E

F

G

H

I

J

MAIN (1) P.C.B. (Side B)

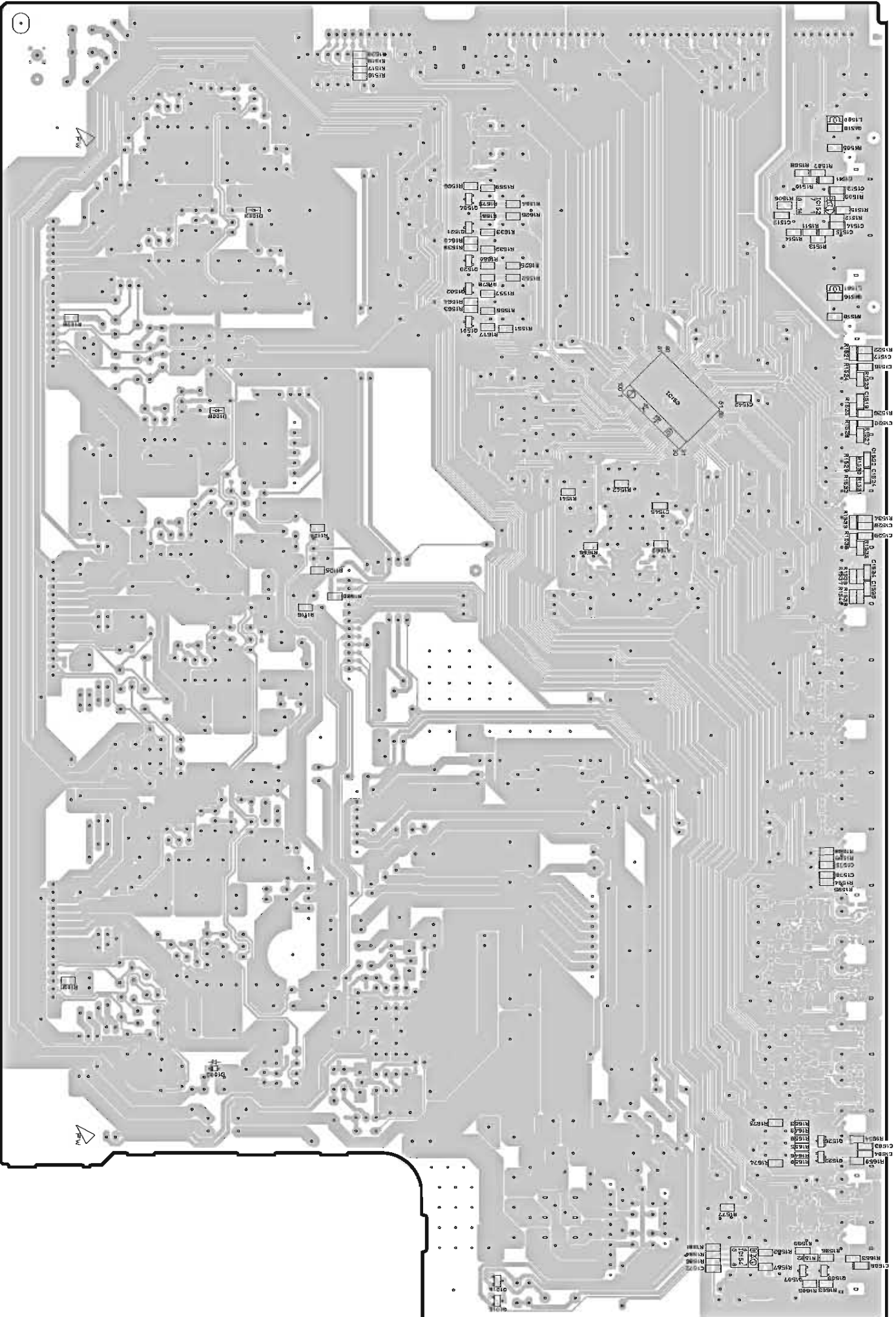

• Semiconductor Location

Ref No.	Location
D1002	H6
D1003	C5
D1008	D6
IC152	C2
IC153	D3
IC154	I3
Q1015	I4
Q1016	I4
Q1501	D4
Q1502	C4
Q1504	C4
Q1507	I2
Q1509	I2
Q1520	C4
Q1521	C4
Q1523	H2
Q1526	H2

7

6

5

4

3

2

1

MAIN (2) P.C.B. (Side A)

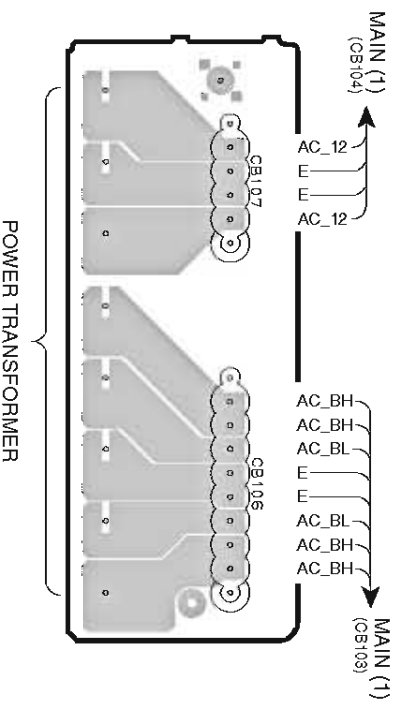

MAIN (3) P.C.B. (Side A)

R, L models

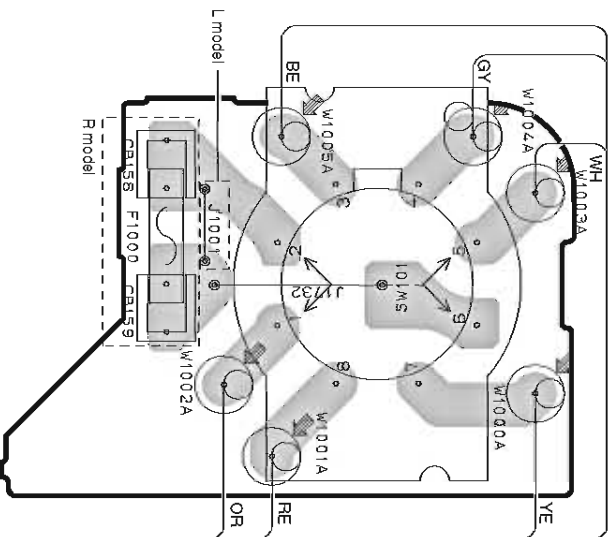

VOLTAGE SELECTOR	
230-240V	1-2/5-6
220V	2-3/6-7
110V	3-4/7-8
120V	4-5/8-1

MAIN (4) P.C.B. (Side A)

R, L models

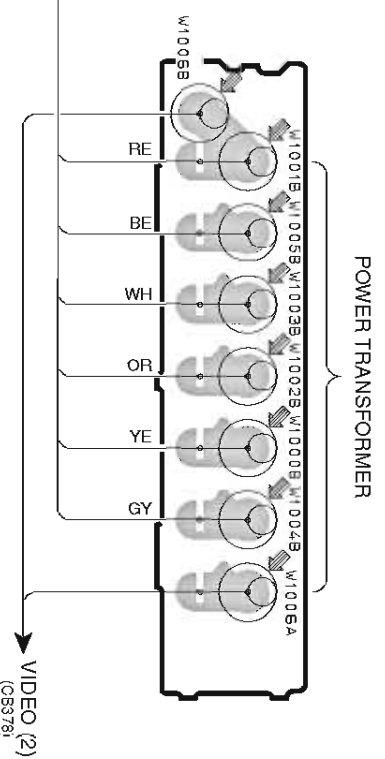

MAIN (5) P.C.B. (Side A)

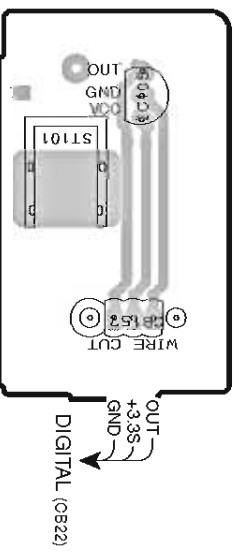

MAIN (6) P.C.B. (Side A)

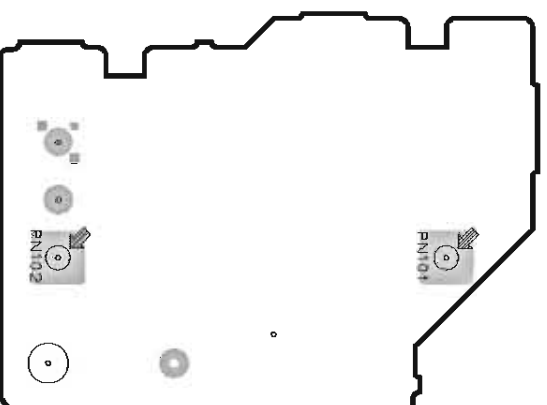

• Semiconductor Location

Ref No.	Location
IC105	CS

A

B

C

D

E

F

G

H

I

J

1

MAIN (2) P.C.B. (Side B)

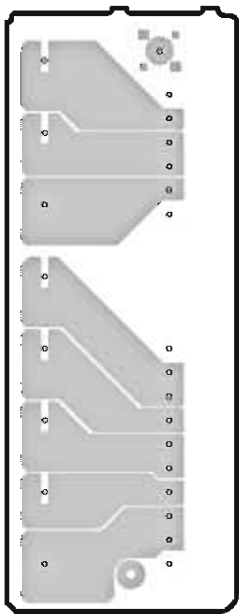

MAIN (3) P.C.B. (Side B)
R, L models

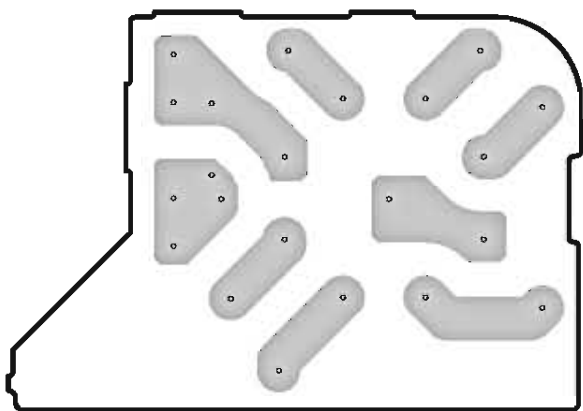

MAIN (4) P.C.B. (Side B)
R, L models

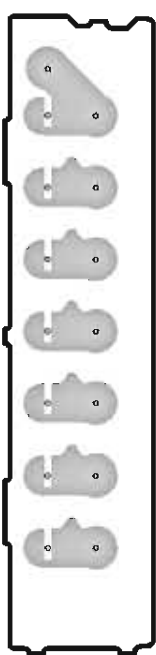

2

3

4

5

6

7

MAIN (5) P.C.B. (Side B)

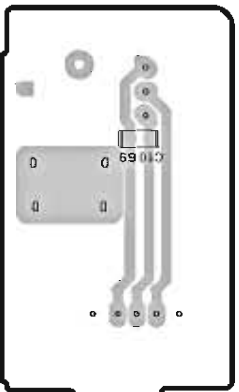

MAIN (6) P.C.B. (Side B)

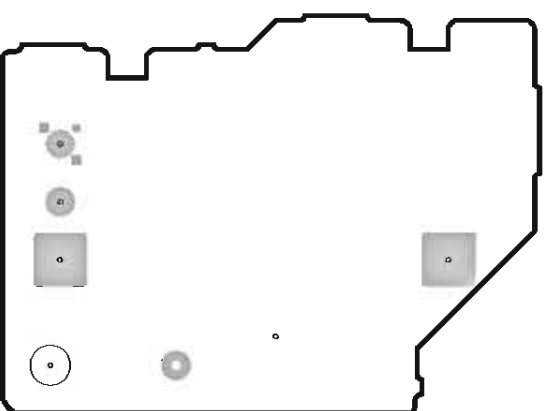

VIDEO (1) P.C.B. (Side A)

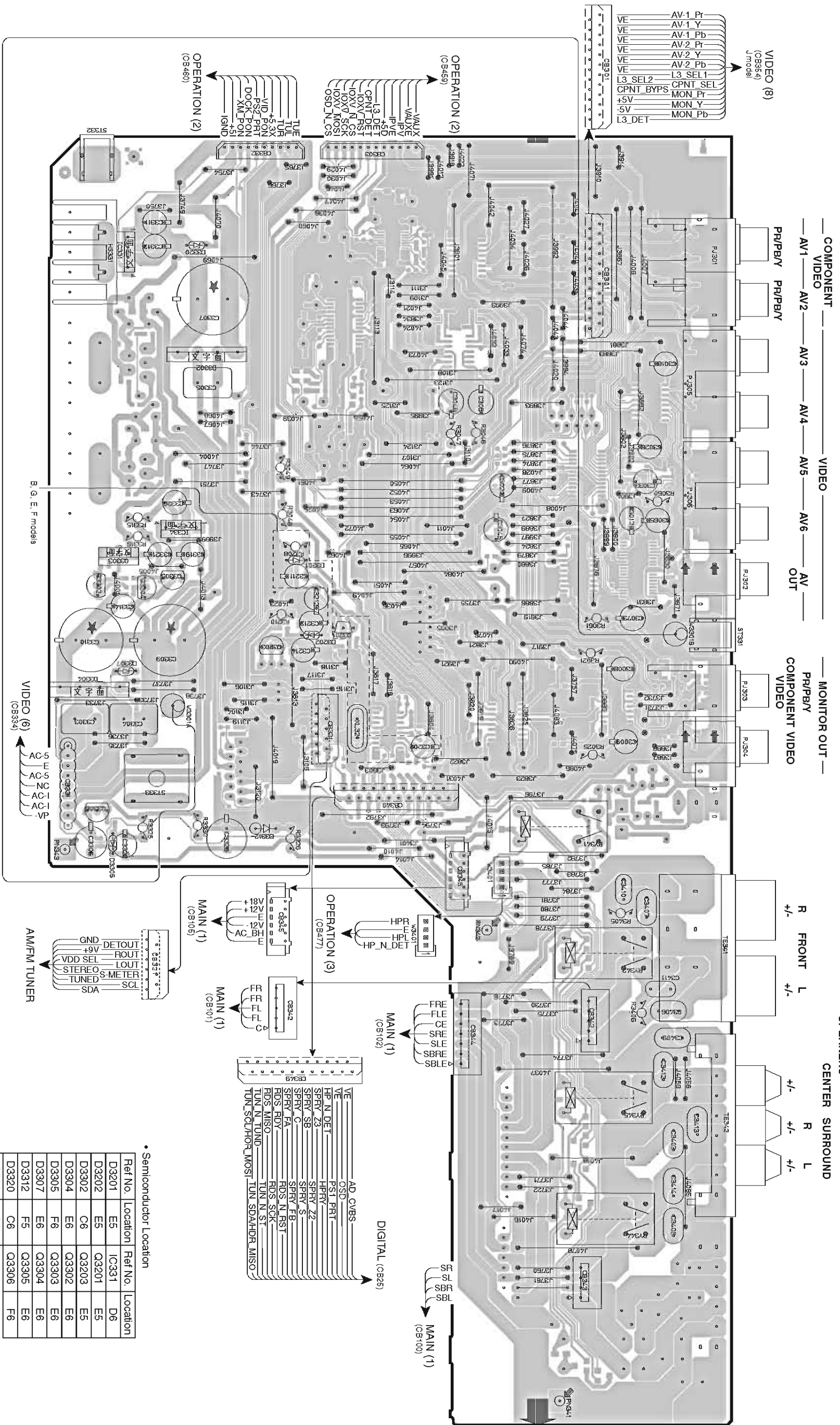

VIDEO (1) P.C.B. (Side B)

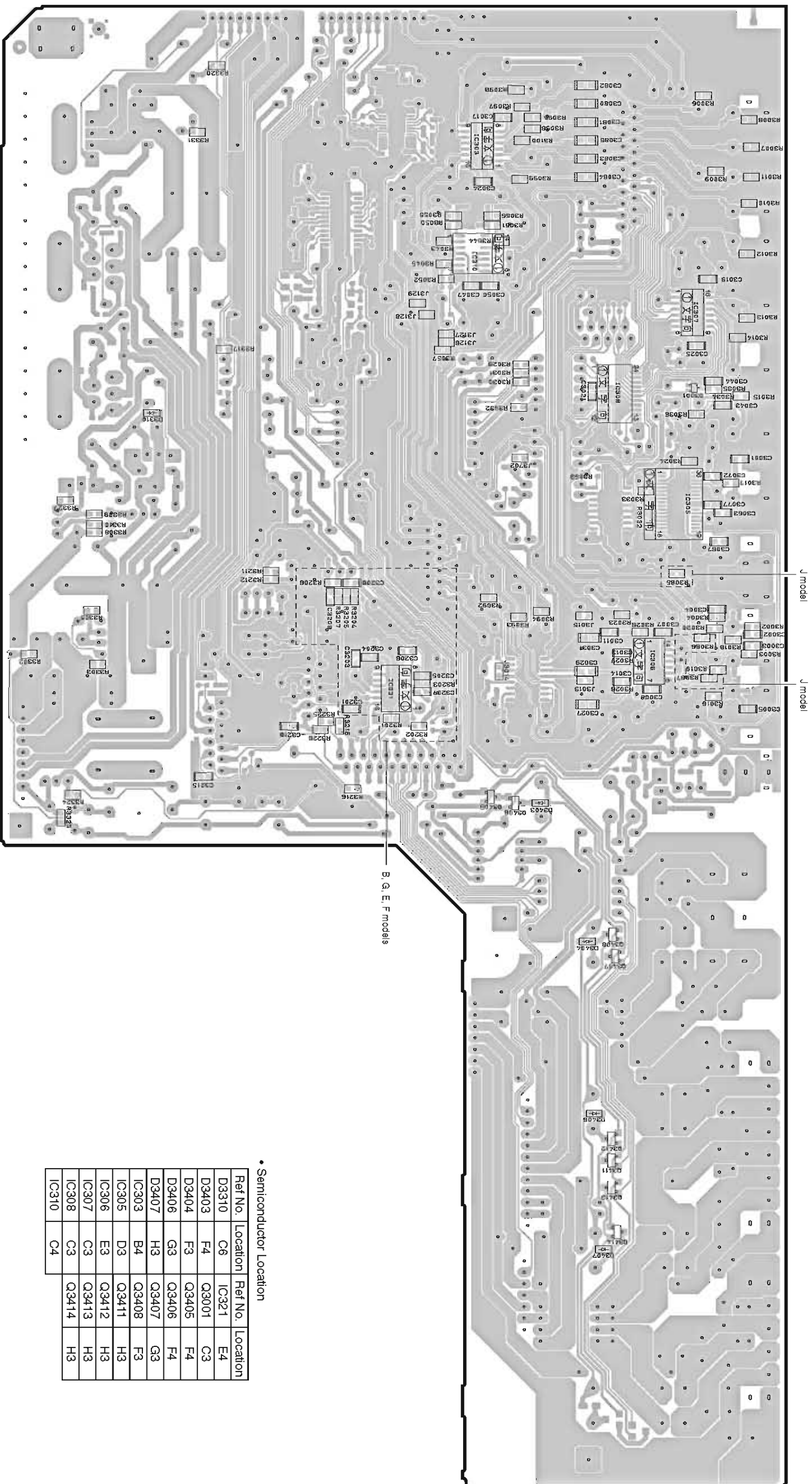

• Semiconductor Location

Ref No.	Location	Ref No.	Location
D3310	C6	IC321	E4
D3403	F4	Q3001	C3
D3404	F3	Q3405	F4
D3406	G3	Q3406	F4
D3407	H3	Q3407	G3
IC303	B4	Q3408	F3
IC305	D3	Q3411	H3
IC306	E3	Q3412	H3
IC307	C3	Q3413	H3
IC308	C3	Q3414	H3
IC310	C4		

1
2
3
4
5
6
7

A B C D E F G H I J

VIDEO (2) P.C.B. (Side A)

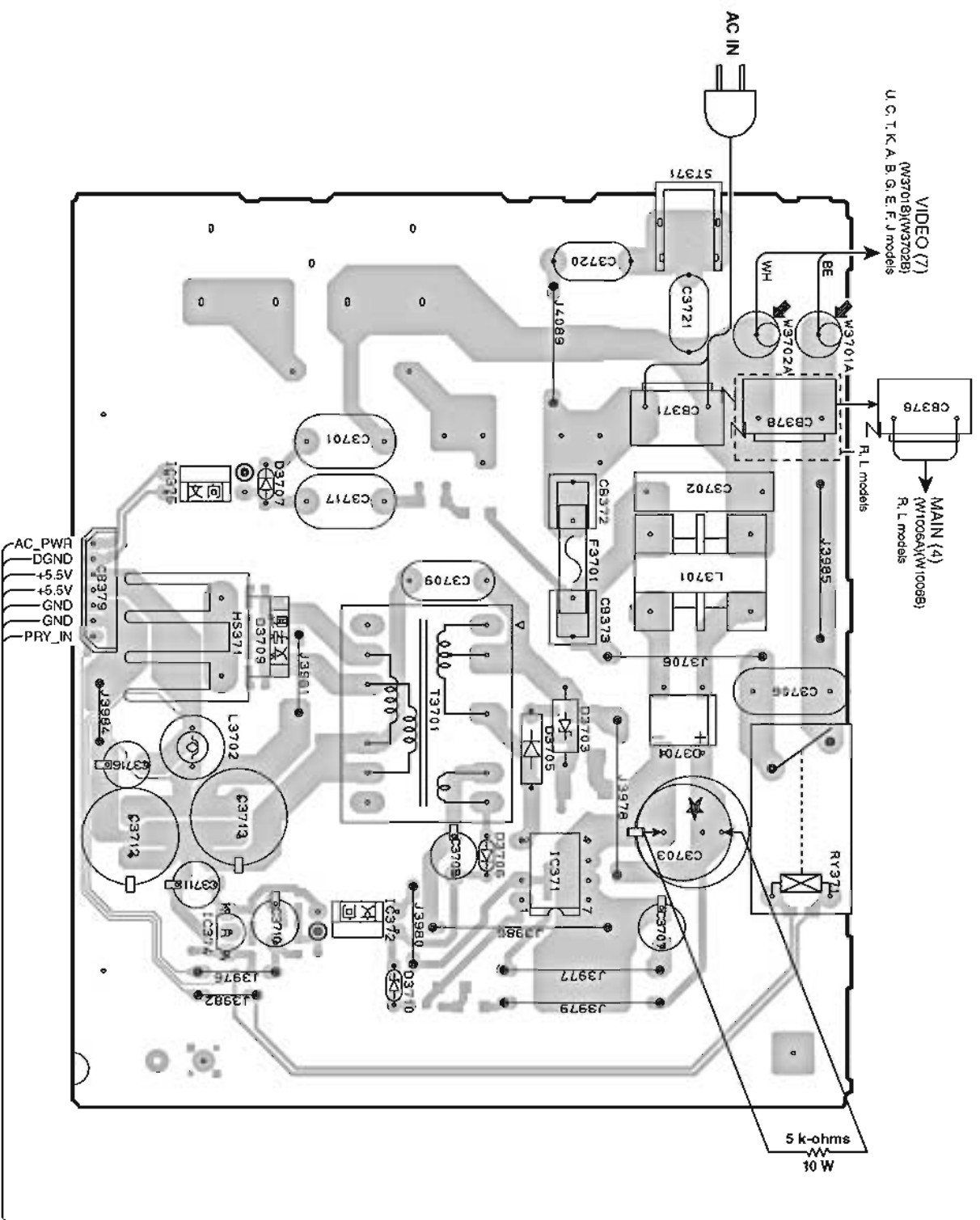

- (Notes)**
- Safety measures**
 - Some internal parts in this product contain high voltages and are dangerous. Be sure to take safety measures during servicing, such as wearing insulating gloves.
 - Note that positions indicated below are dangerous even after the power is turned off because an electric charge remains and a high voltage continues to exist there. Before starting any repair work, perform discharge by connecting a discharge resistor (5k-ohms/10W) between terminals at following positions. The time required for discharging is about 30 seconds.
 - C3703 on VIDEO (2) P.C.B.

VIDEO (3) P.C.B. (Side A)

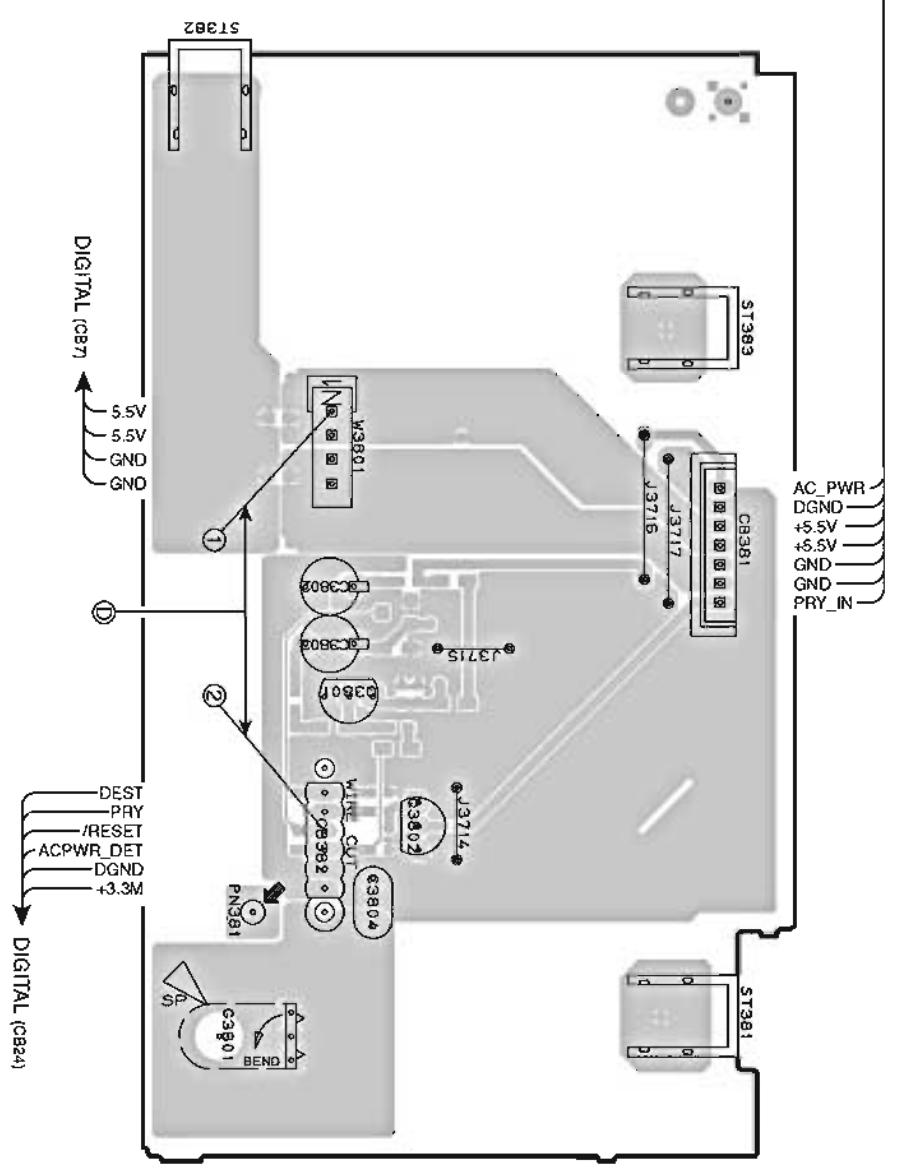

- (注意)**
- 安全対策**
 - この製品の内部には高電圧部分があり危険です。修理の際は、絶縁性の手袋を使用するなど安全対策を行ってください。
 - 下記箇所には電圧をOFFにした後も電圧が残り、高電圧が維持されており危険です。修理作業前に放電用抵抗 (5 kΩ/10 W) を下記箇所の端子間に接続して放電してください。放電所要時間は約30秒間です。
 - VIDEO (2) P.C.B. の C3703

• Semiconductor Location

Ref No.	Location	Ref No.	Location
D3701	D3	IC371	E3
D3703	D3	IC372	E4
D3705	D3	IC374	E5
D3706	E4	IC375	C5
D3707	C4	Q3801	I4
D3709	D4	Q3802	I4
D3710	E4		

POINT ① / W3801 (+5.5V), ② / C3822 (RESET)

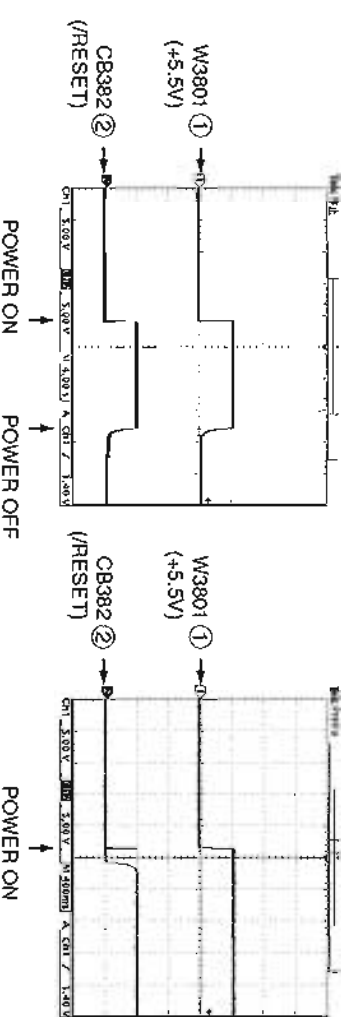

VIDEO (6) P.C.B. (Side A)

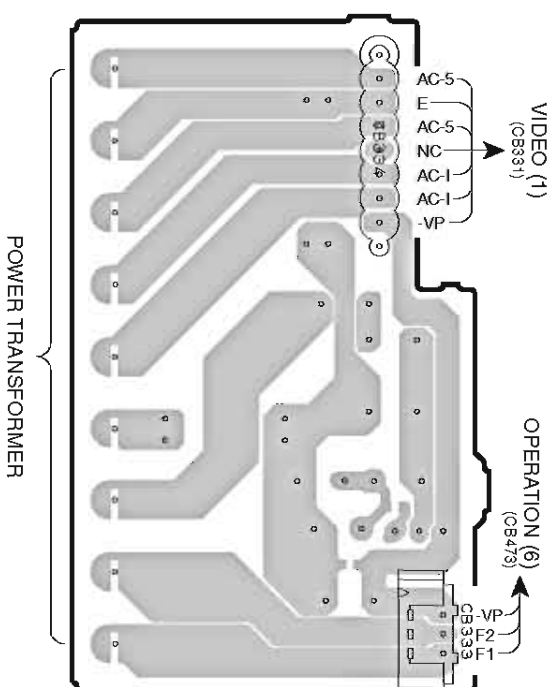

VIDEO (7) P.C.B. (Side A)
U, C, T, K, A, B, G, E, F, J models

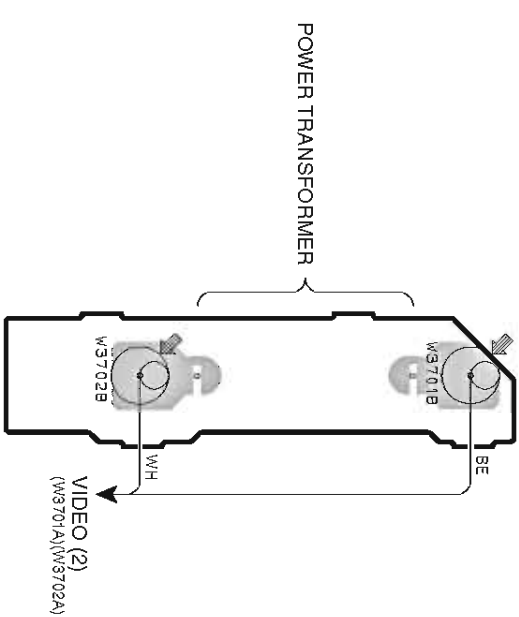

VIDEO (8) P.C.B. (Side A)

J model

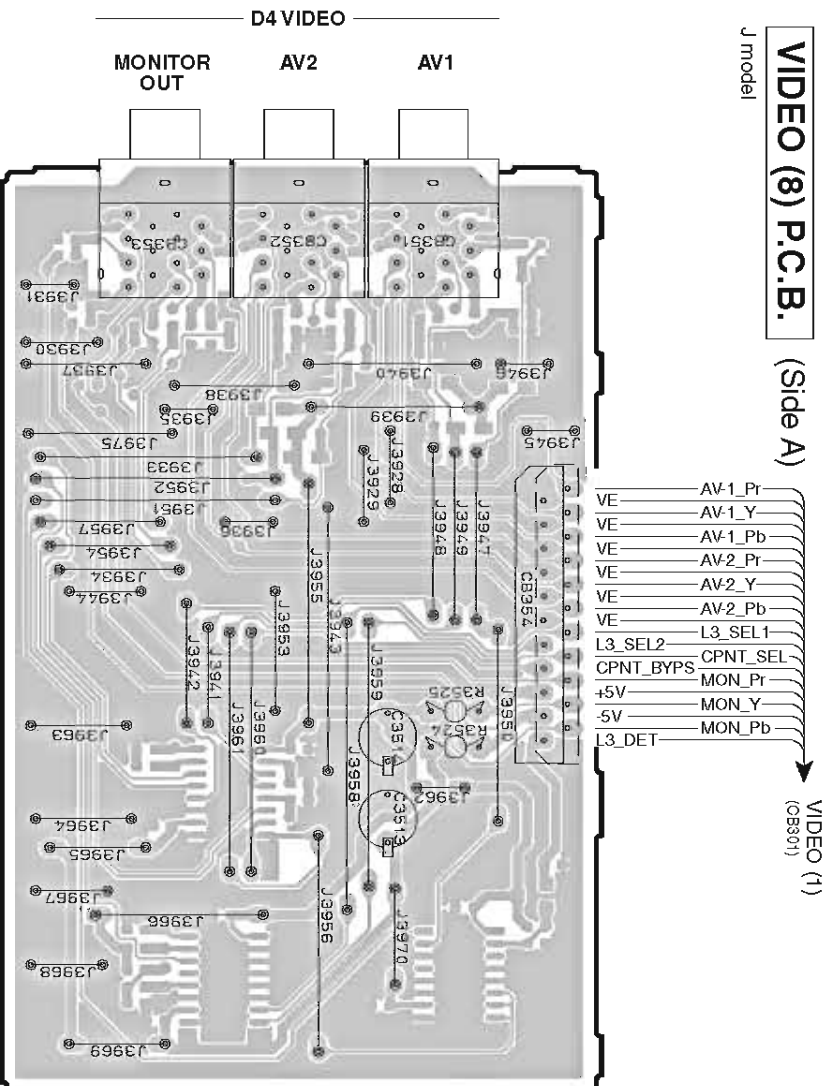

A B C D E F G H I J

1

VIDEO (6) P.C.B. (Side B)

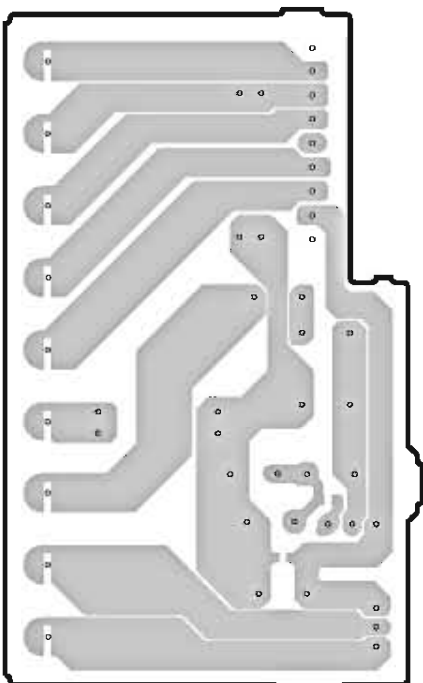

VIDEO (7) P.C.B. (Side B)

U, C, T, K, A, B, G, E, F, J models



2

3

4

5

6

7

VIDEO (8) P.C.B. (Side B)

J model

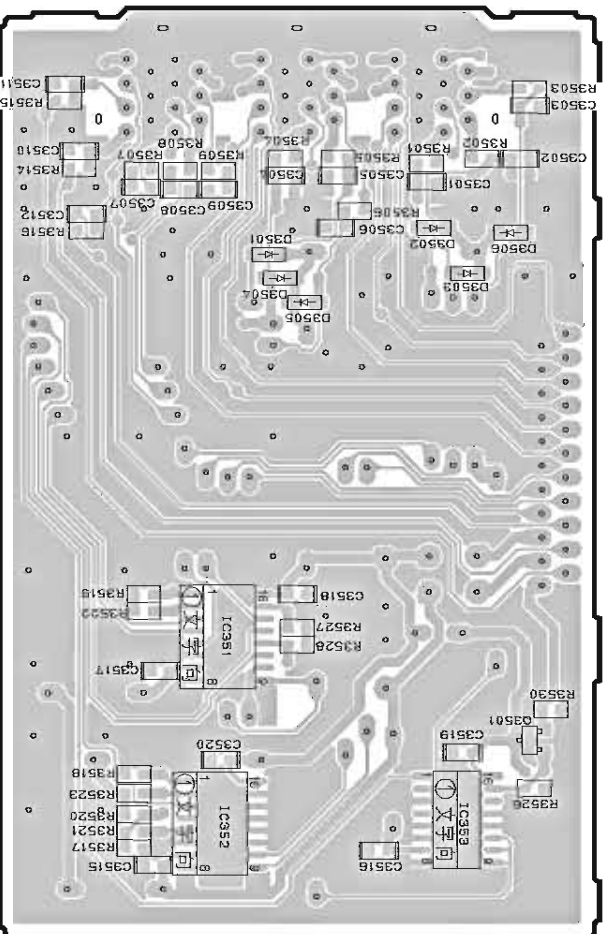

• Semiconductor Location

Ref No.	Location
D3501	C6
D3502	C6
D3503	C6
D3504	C6
D3505	C6
D3506	C5
IC351	D6
IC352	E6
IC353	E6
Q3501	E5

MEMO

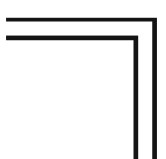
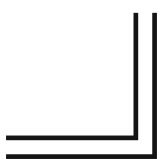
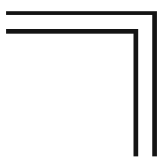

MEMO

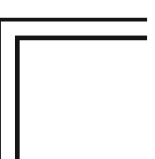
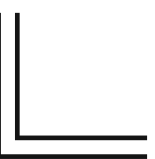
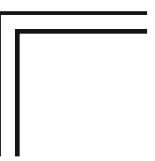
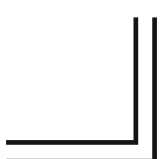

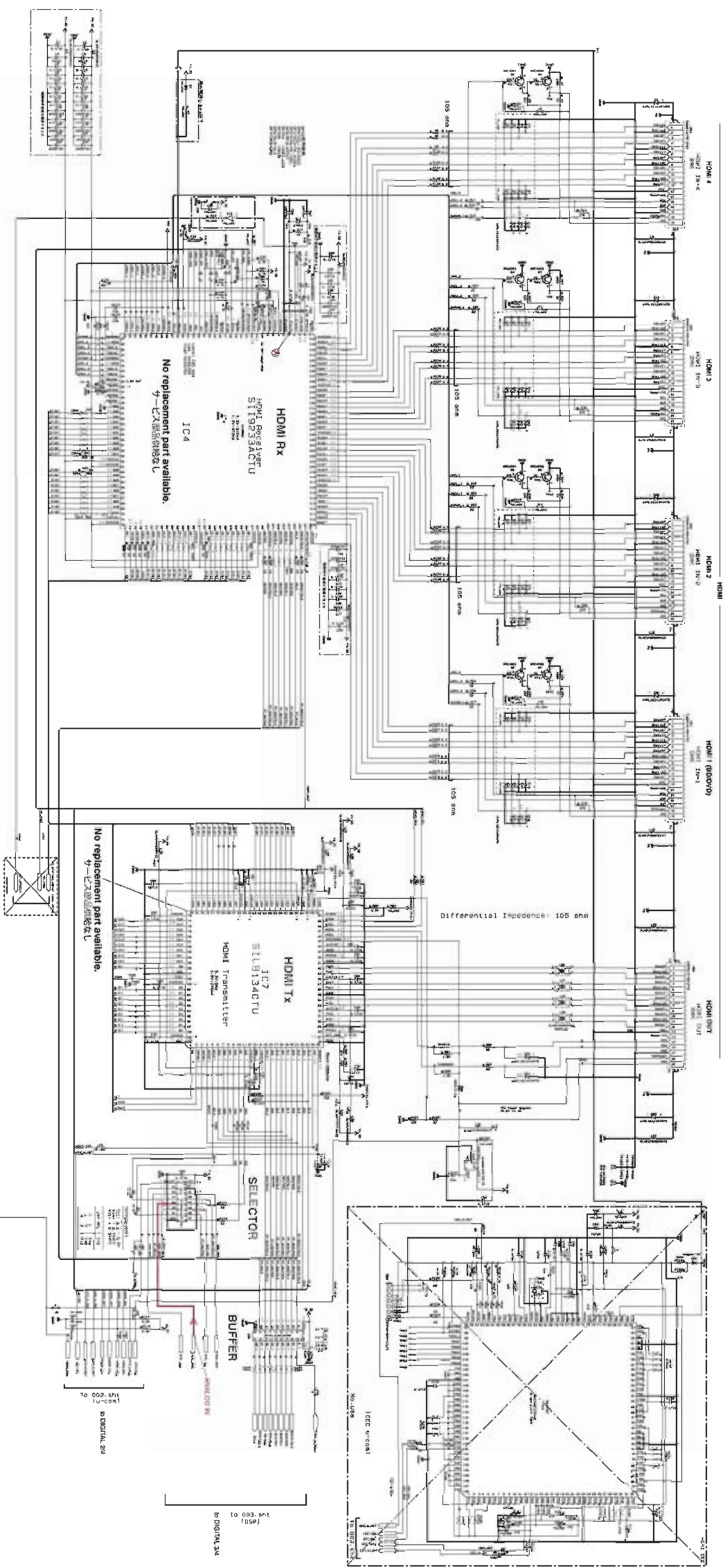

RECOMMENDED PARTS OR EQUIVALENTS

Part No.	Part Name	Quantity
IC4	ST19233ACTU	1
IC7	S119134ACTU	1

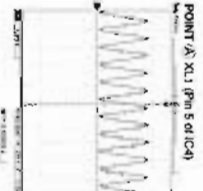

IC2: SN74LVCA64PWR
Octal Bus Inverter with 3-STATE Outputs

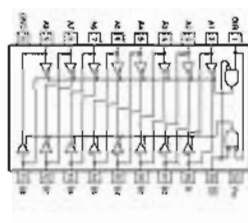

IC4: SI9233ACTU
HDMI Receiver

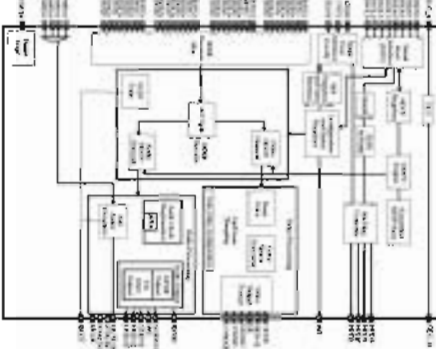

IC5: RI1726121D-E2-F
Voltage Regulator

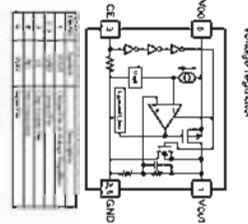

IC7: S119134ACTU
HDMI Transmitter

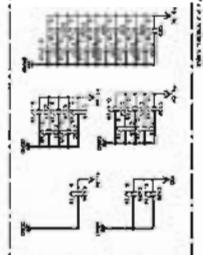

IC8 & B09282SE-E2
1.5A Step-Down DC/DC Converter

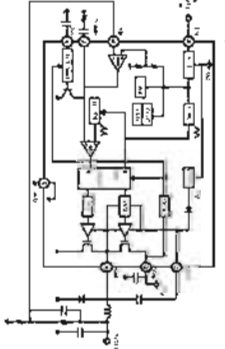

IC10: N4282E3-06
Low dropout voltage regulator

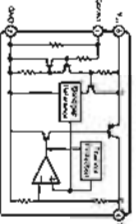

IC11: TC74VHC15FT
Quad 2-Input Inverter

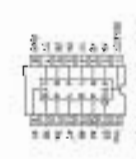

IC13: RI1726H0D-11-F
Voltage Regulator

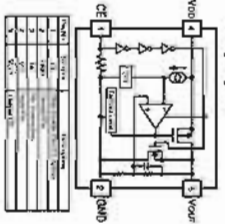

Page 121 18
to VIDEO Q1.W0801

Part No.	Part Name	Quantity
IC1	SI9233ACTU	1
IC2	S119134ACTU	1
IC3	RI1726121D-E2-F	1
IC4	SI9233ACTU	1
IC5	RI1726121D-E2-F	1
IC6	B09282SE-E2	1
IC7	S119134ACTU	1
IC8	N4282E3-06	1
IC9	TC74VHC15FT	1
IC10	RI1726H0D-11-F	1

* All inductor are measured with a 10MHz DC electronic voltmeter.
* Component having special characteristics are marked with asterisk.
* Components having specifications equal to those originally provided.
* Schematic diagram is subject to change without notice.

● 電圧、電流値は、10MHzの電圧計で測定した値を示す。
● 特殊な特性を有する部品は、*で示す。
● 元の仕様と同等の部品を使用すること。
● 回路図は、予告なく変更される場合があります。

Page 115 [10]
to OPERATION (1) CAS40

Page 117 [C]
to MAIN (1) CAS17

Page 118 [K]
to MAIN (1) CAS6

Page 121 [D]
to VIDEO (1) CAS2

Page 120 [GR]
to VIDEO (1) CAS49

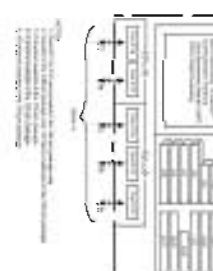
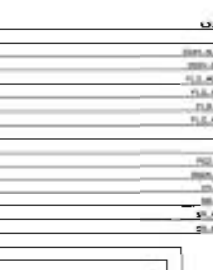
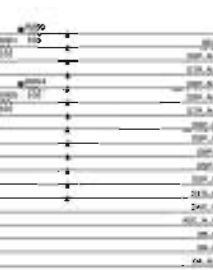
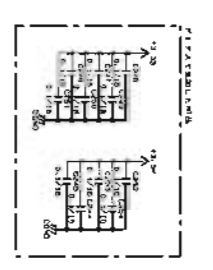
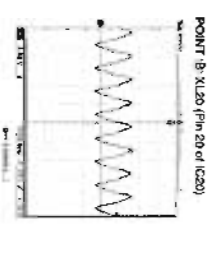
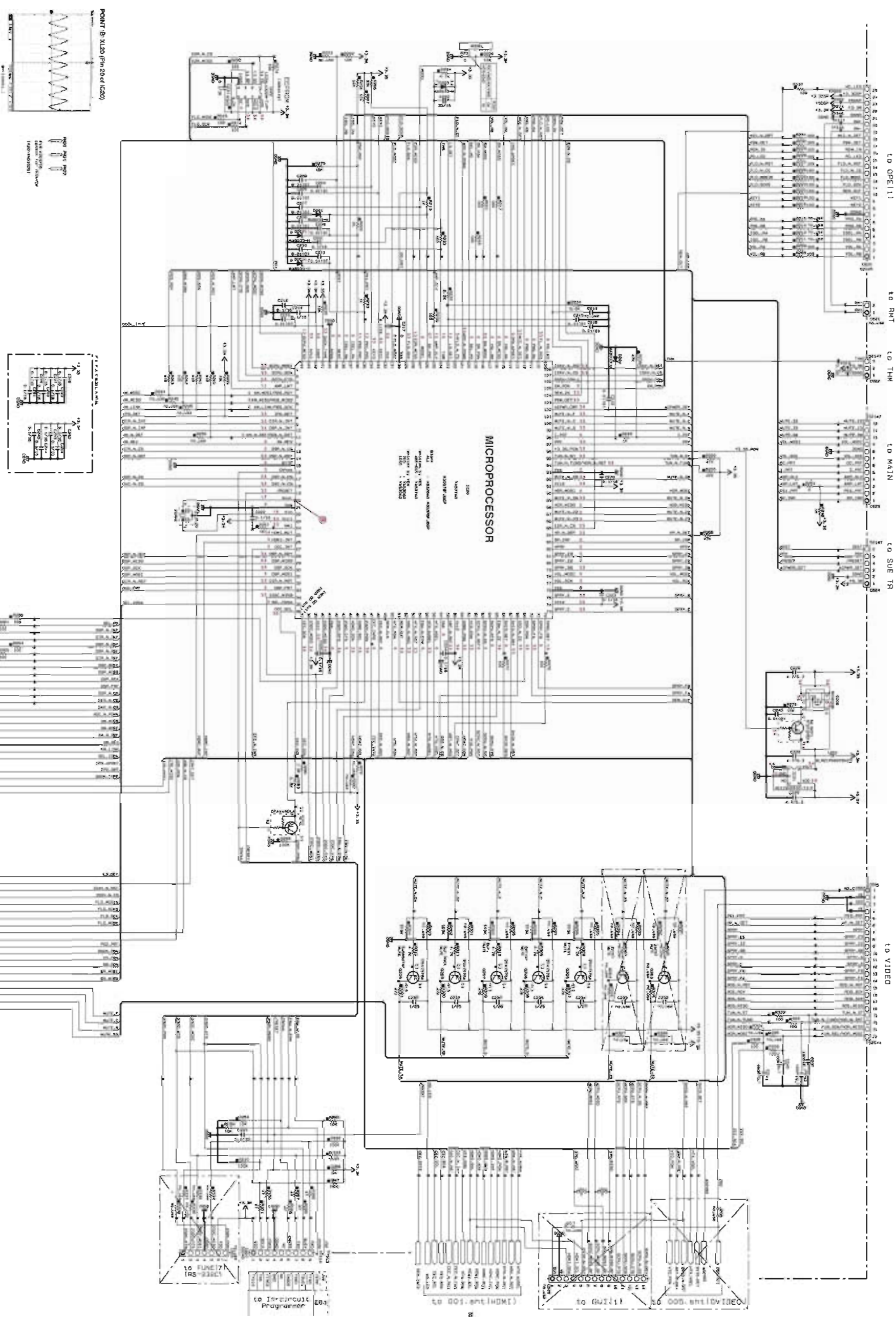

* All waveforms are measured with a 10MHz/100ps electronic voltmeter.
* Component values are approximate and must be repeated with parts having specifications equal to those originally installed.
* Schematic diagram is subject to change without notice.

● 測定は、10MHz/100psの電子電圧計を用いて行われ、測定値は概算値です。
● 部品値は概算値であり、元の仕様と同等の部品を交換する必要があります。
● 回路図は変更される可能性があります。変更なしと見做すことができません。

TO 003: SH1 (DSP1)
TO DIGITAL 2/4

TO 004: SH1 (AD-DA)
TO DIGITAL 1/4

TO 005: SH1 (AD-DA)
TO DIGITAL 1/4

TO 006: SH1 (AD-DA)
TO DIGITAL 1/4

Key detector for AD port
Key speed (kHz) pulsewidth (ns) 100µs

Key	Speed (kHz)	Pulsewidth (ns)	100µs
001	0.1-1.0	10-100	100-1000
002	1.0-10.0	100-1000	1000-10000
003	10.0-100.0	1000-10000	10000-100000
004	100.0-1000.0	10000-100000	100000-1000000
005	1000.0-10000.0	100000-1000000	1000000-10000000
006	10000.0-100000.0	1000000-10000000	10000000-100000000
007	100000.0-1000000.0	10000000-100000000	100000000-1000000000
008	1000000.0-10000000.0	100000000-1000000000	1000000000-10000000000
009	10000000.0-100000000.0	1000000000-10000000000	10000000000-100000000000
010	100000000.0-1000000000.0	10000000000-100000000000	100000000000-1000000000000

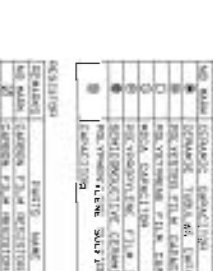
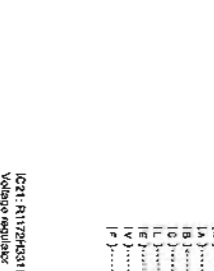
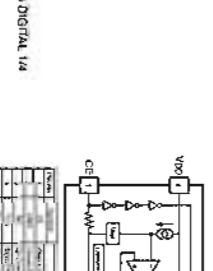
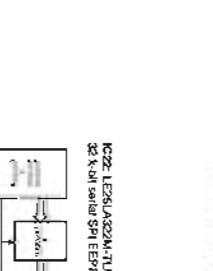
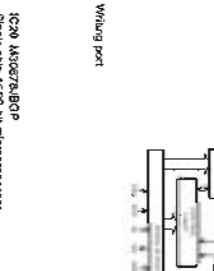
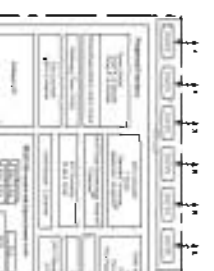
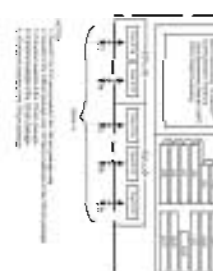

NOTICE (page 3)

Model	Country
101	Japan
102	USA
103	Canada
104	UK
105	France
106	Germany
107	Italy
108	Spain
109	Sweden
110	Switzerland
111	Netherlands
112	Belgium
113	Austria
114	Portugal
115	Greece
116	Turkey
117	India
118	China
119	South Korea
120	Hong Kong
121	Taiwan
122	Singapore
123	Malaysia
124	Philippines
125	Thailand
126	Indonesia
127	Sri Lanka
128	Burma
129	Cambodia
130	Laos
131	Vietnam
132	Myanmar
133	Bhutan
134	Nepal
135	Bangladesh
136	Pakistan
137	Afghanistan
138	Yemen
139	Saudi Arabia
140	UAE
141	Qatar
142	Oman
143	Kuwait
144	Saudi Arabia
145	UAE
146	Qatar
147	Oman
148	Kuwait
149	Saudi Arabia
150	UAE

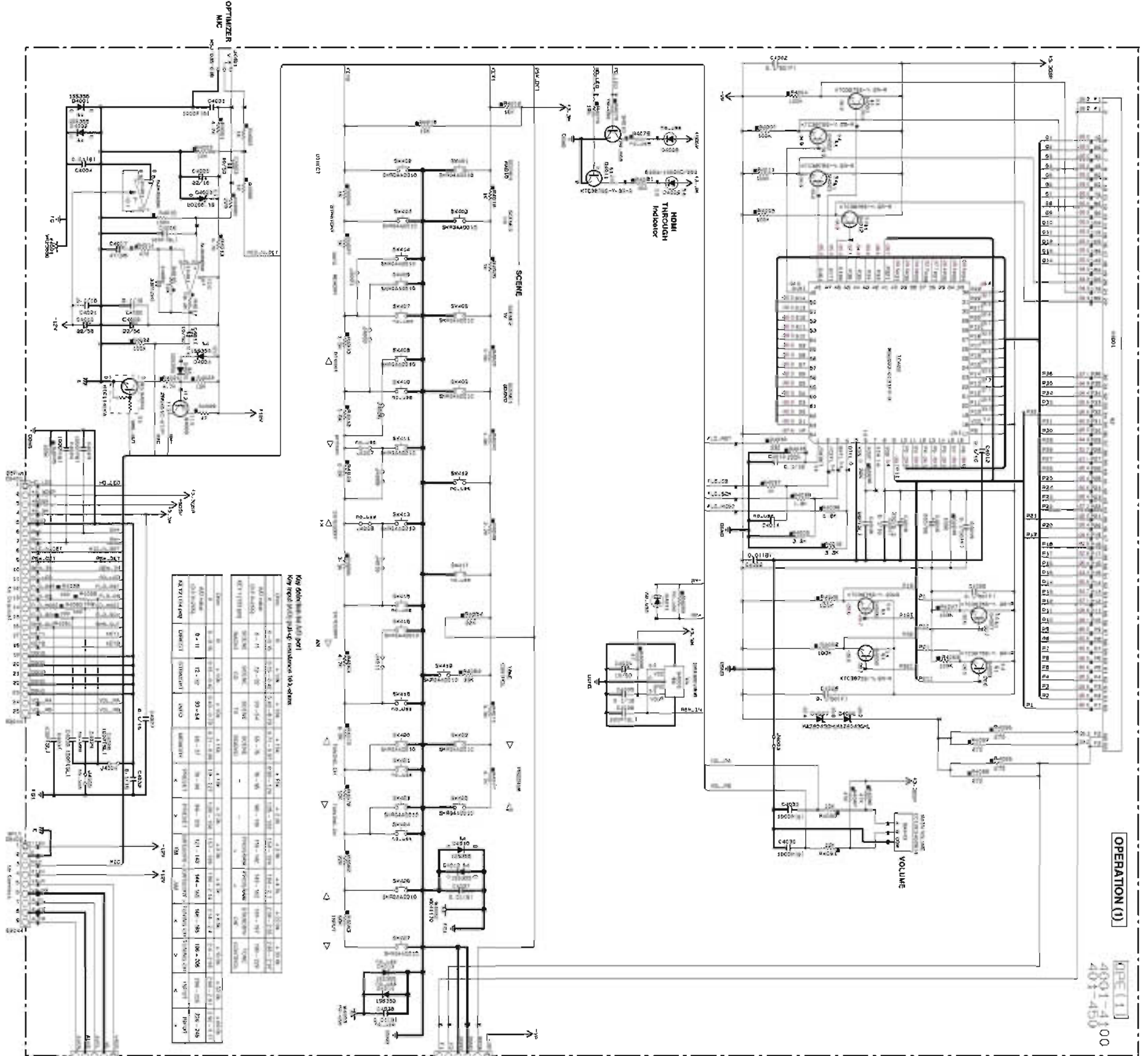

Page 112 [32] to DIGITAL_CIRCU

Page 116 [35] to OPERATION (2)_C8641

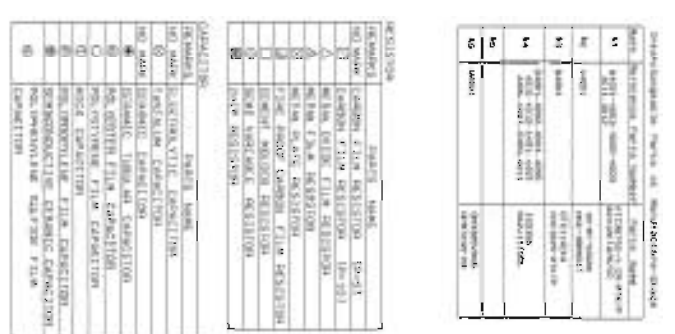

NOTICE

1. 本機は、電源スイッチをONにした状態で、電源ケーブルを接続してください。
2. 本機は、電源スイッチをONにした状態で、電源ケーブルを接続してください。
3. 本機は、電源スイッチをONにした状態で、電源ケーブルを接続してください。
4. 本機は、電源スイッチをONにした状態で、電源ケーブルを接続してください。
5. 本機は、電源スイッチをONにした状態で、電源ケーブルを接続してください。
6. 本機は、電源スイッチをONにした状態で、電源ケーブルを接続してください。
7. 本機は、電源スイッチをONにした状態で、電源ケーブルを接続してください。
8. 本機は、電源スイッチをONにした状態で、電源ケーブルを接続してください。
9. 本機は、電源スイッチをONにした状態で、電源ケーブルを接続してください。
10. 本機は、電源スイッチをONにした状態で、電源ケーブルを接続してください。

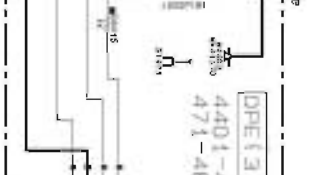
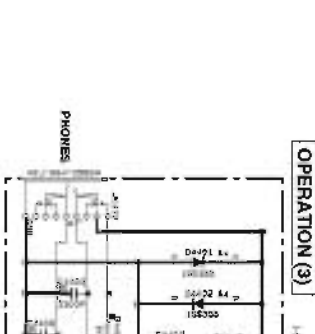
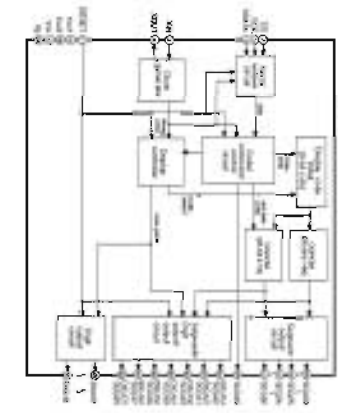

Page 120 [38] to VIDEO (6)_C8633

Page 120 [38] to VIDEO (1)_W3401

* All voltages are measured with a 10MΩ/100 pF electronic voltmeter.
 * Component values are shown in parentheses next to the component.
 * Parts having standard values are shown in parentheses next to the component.
 * Schematic diagrams are subject to change without notice.

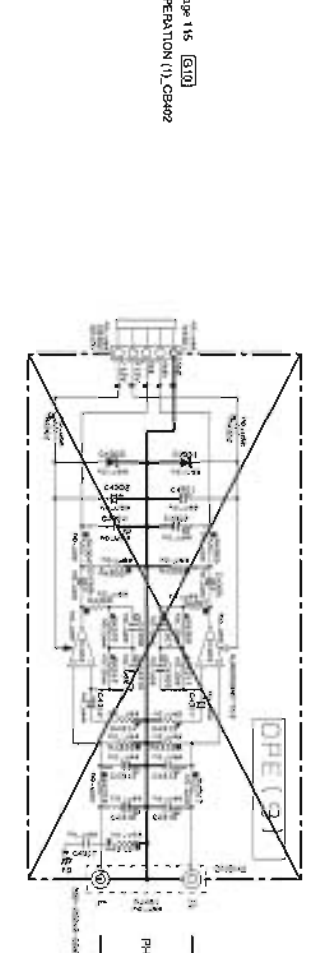
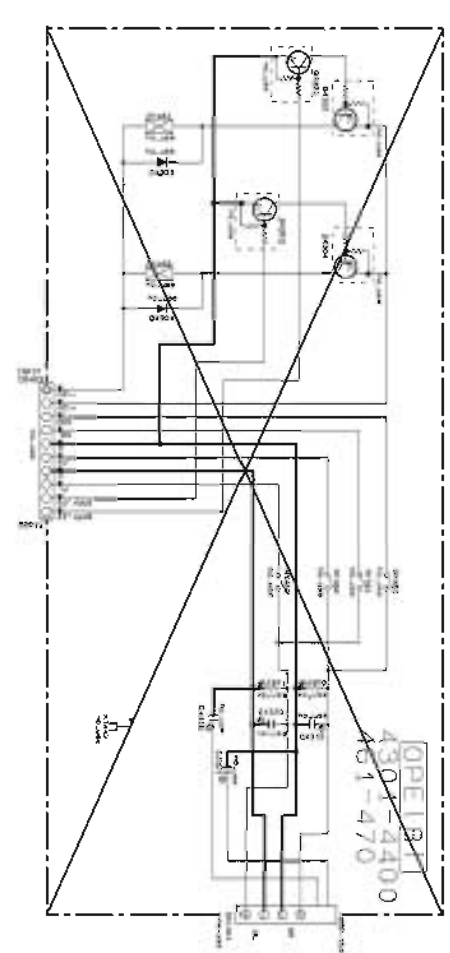
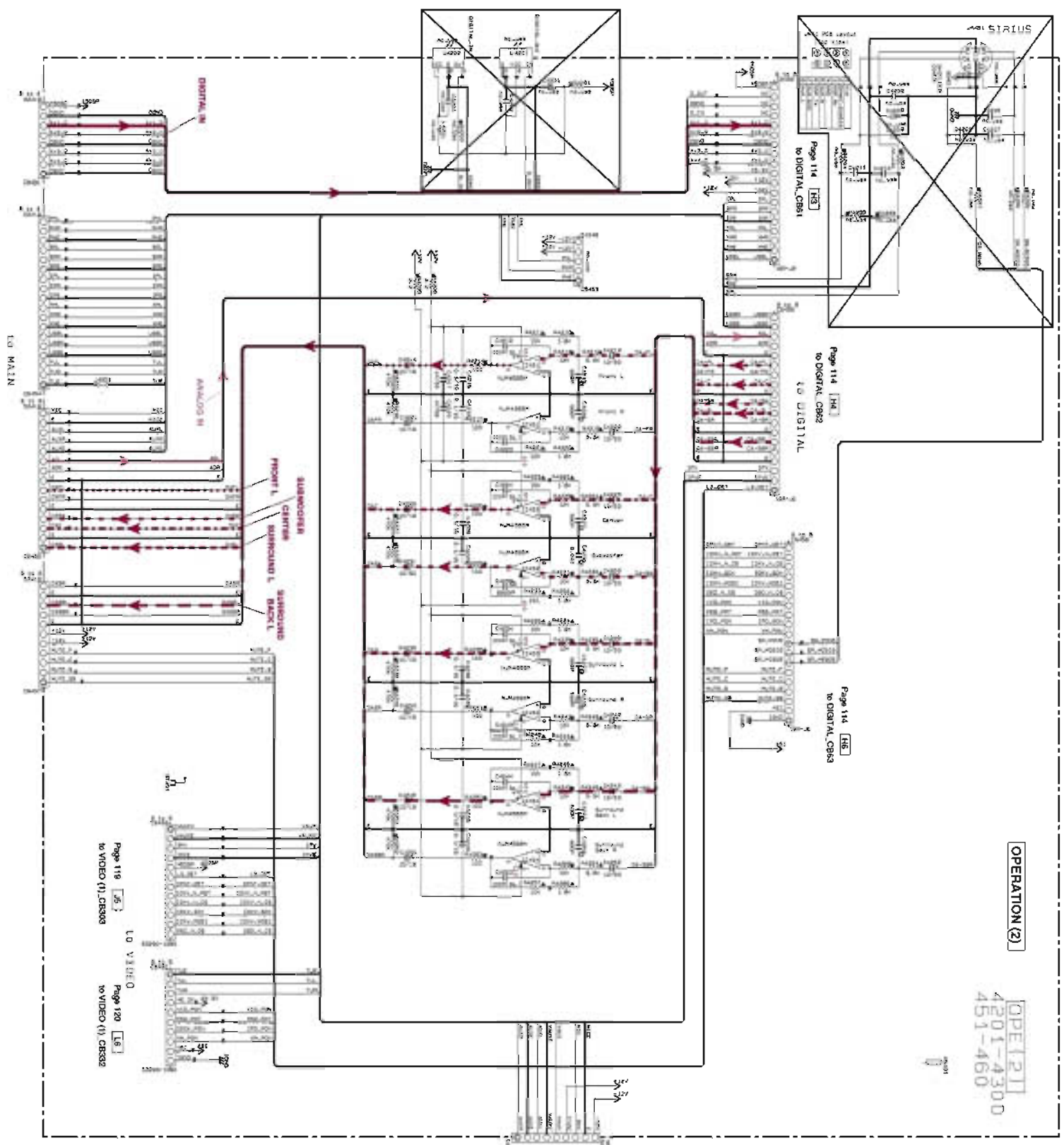

NO.	DESCRIPTION	QTY	REVISION
1	REVISION		
2	REVISION		
3	REVISION		
4	REVISION		
5	REVISION		
6	REVISION		
7	REVISION		
8	REVISION		
9	REVISION		
10	REVISION		
11	REVISION		
12	REVISION		
13	REVISION		
14	REVISION		
15	REVISION		
16	REVISION		
17	REVISION		
18	REVISION		
19	REVISION		
20	REVISION		
21	REVISION		
22	REVISION		
23	REVISION		
24	REVISION		
25	REVISION		
26	REVISION		
27	REVISION		
28	REVISION		
29	REVISION		
30	REVISION		
31	REVISION		
32	REVISION		
33	REVISION		
34	REVISION		
35	REVISION		
36	REVISION		
37	REVISION		
38	REVISION		
39	REVISION		
40	REVISION		
41	REVISION		
42	REVISION		
43	REVISION		
44	REVISION		
45	REVISION		
46	REVISION		
47	REVISION		
48	REVISION		
49	REVISION		
50	REVISION		

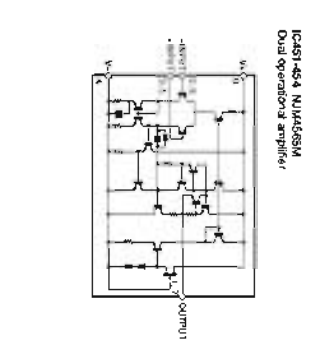

* All voltages are measured with a 10MΩ/100 pF electronic voltmeter.
 * Capacitors are measured with a 10MΩ/100 pF electronic voltmeter.
 * Chip parts having specifications equal to those originally furnished.
 * Schematic diagrams subject to change without notice.

● 電圧は、10MΩ/100pF電子電圧計で測定した値を示す。
 ● 容量は、10MΩ/100pF電子電圧計で測定した値を示す。
 ● チップ部品は、元の仕様と同等のものを使用する。
 ● 図面は、変更なしと見做す。

1
2
3
4
5
6
7
8
9
10

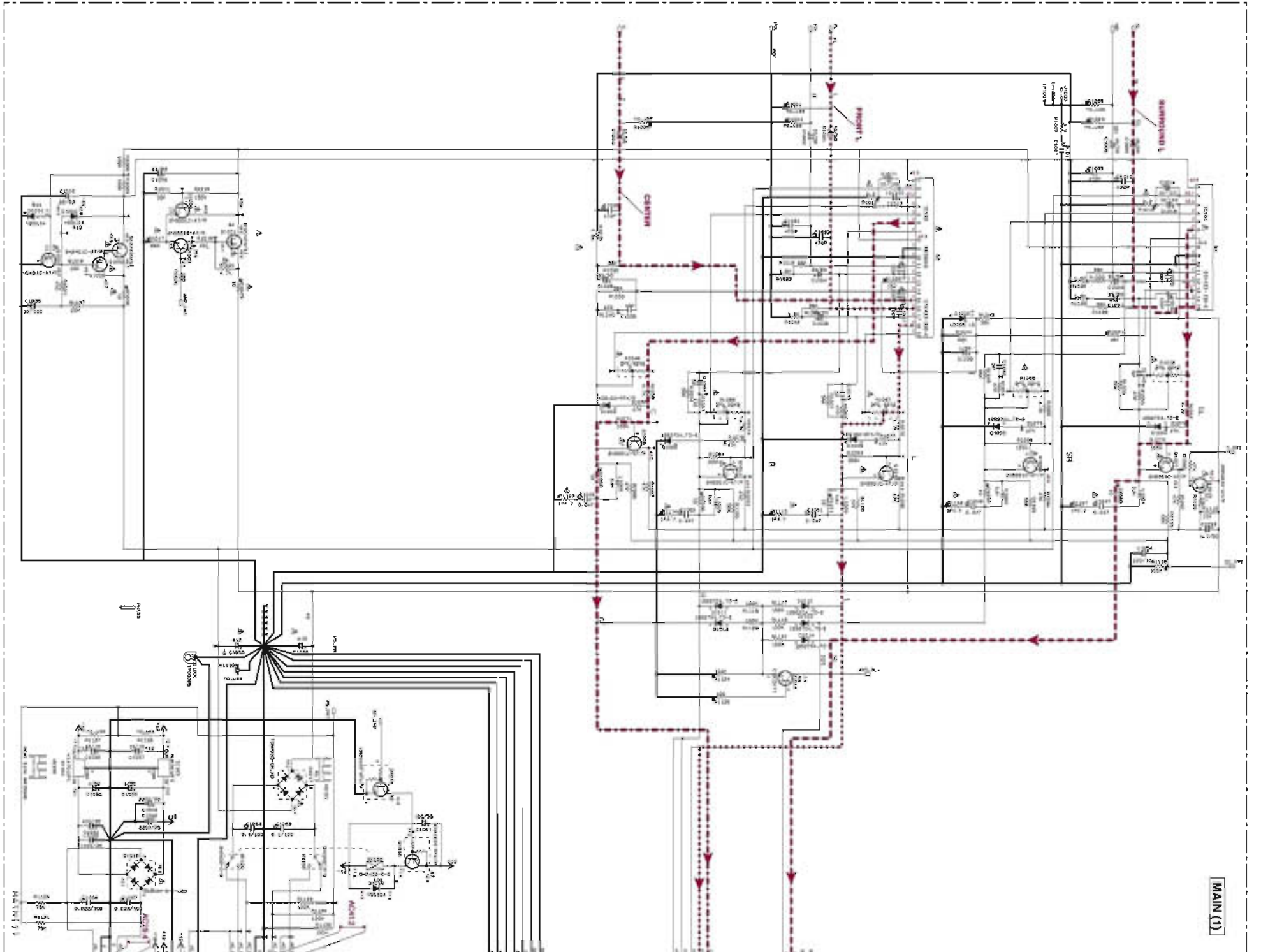

MAIN (1)

RESISTORS

NO.	RESISTOR VALUE	POWER RATING	TEMP. COEFF.
1	100K	1/4W	±1%
2	100K	1/4W	±1%
3	100K	1/4W	±1%
4	100K	1/4W	±1%
5	100K	1/4W	±1%
6	100K	1/4W	±1%
7	100K	1/4W	±1%
8	100K	1/4W	±1%
9	100K	1/4W	±1%
10	100K	1/4W	±1%

NOTICE (Rev. 1)

1. All voltages are measured with a 10MΩ/100V AC electronic voltmeter.
2. Component values are given in standard values unless otherwise specified.
3. Component values in parentheses are for reference only.
4. Component values in brackets are for reference only.
5. Component values in italics are for reference only.
6. Component values in bold are for reference only.
7. Component values in bold italics are for reference only.
8. Component values in bold bold are for reference only.
9. Component values in bold bold italics are for reference only.
10. Component values in bold bold bold are for reference only.

Page 120 [B6] to VIDEO (1) CS934

Page 120 [B6] to VIDEO (1) CS934

Page 120 [B6] to VIDEO (1) CS934

RESISTOR VALUE LIST

NO.	RESISTOR VALUE	POWER RATING	TEMP. COEFF.
1	100K	1/4W	±1%
2	100K	1/4W	±1%
3	100K	1/4W	±1%
4	100K	1/4W	±1%
5	100K	1/4W	±1%
6	100K	1/4W	±1%
7	100K	1/4W	±1%
8	100K	1/4W	±1%
9	100K	1/4W	±1%
10	100K	1/4W	±1%

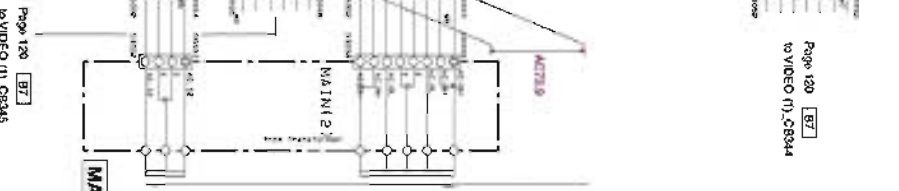

MAIN (2)

MAIN (3)

MAIN (4)

MAIN (5)

MAIN (6)

VOLTAGE SELECTOR

NO.	RESISTOR VALUE	POWER RATING	TEMP. COEFF.
1	100K	1/4W	±1%
2	100K	1/4W	±1%
3	100K	1/4W	±1%
4	100K	1/4W	±1%
5	100K	1/4W	±1%
6	100K	1/4W	±1%
7	100K	1/4W	±1%
8	100K	1/4W	±1%
9	100K	1/4W	±1%
10	100K	1/4W	±1%

Page 121 [C7] to VIDEO (2) CS938

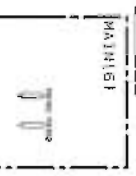

MAIN (7)

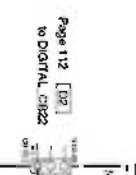

MAIN (8)

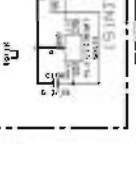

MAIN (9)

RESISTOR VALUE LIST

NO.	RESISTOR VALUE	POWER RATING	TEMP. COEFF.
1	100K	1/4W	±1%
2	100K	1/4W	±1%
3	100K	1/4W	±1%
4	100K	1/4W	±1%
5	100K	1/4W	±1%
6	100K	1/4W	±1%
7	100K	1/4W	±1%
8	100K	1/4W	±1%
9	100K	1/4W	±1%
10	100K	1/4W	±1%

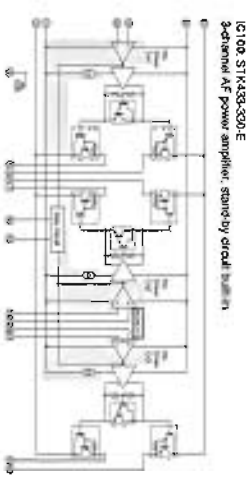

IC00 ST142830-E 2-channel AF power amplifier, standby circuit built-in

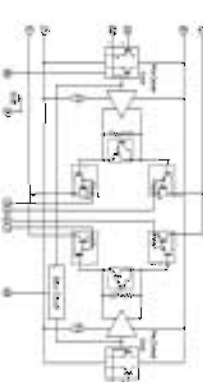

IC01 ST1443310-E 2-channel AF power amplifier, standby circuit built-in

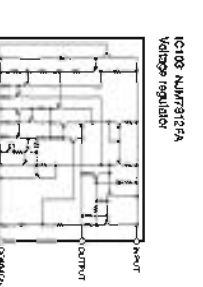

IC02 KA7812CA Voltage regulator

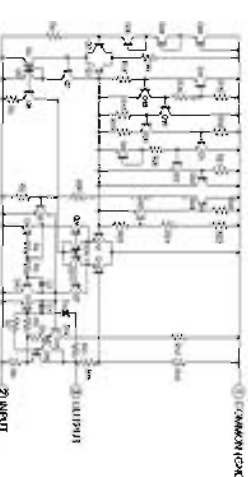

IC04 KA7812B Voltage regulator

* All voltages are measured with a 10MΩ/100V AC electronic voltmeter.

* Component values are given in standard values unless otherwise specified.

* Component values in parentheses are for reference only.

* Component values in brackets are for reference only.

* Component values in italics are for reference only.

* Component values in bold are for reference only.

* Component values in bold italics are for reference only.

* Component values in bold bold are for reference only.

* Component values in bold bold italics are for reference only.

● 電圧計は、10MΩ/100V AC 電子電圧計を用いて測定した値を示します。

● 部品値は標準値を示します。ただし、括弧内の値は参考値です。

● 括弧内の値は参考値です。

● 斜体の値は参考値です。

● 太字の値は参考値です。

● 太字斜体の値は参考値です。

● 太字太字の値は参考値です。

● 太字太字斜体の値は参考値です。

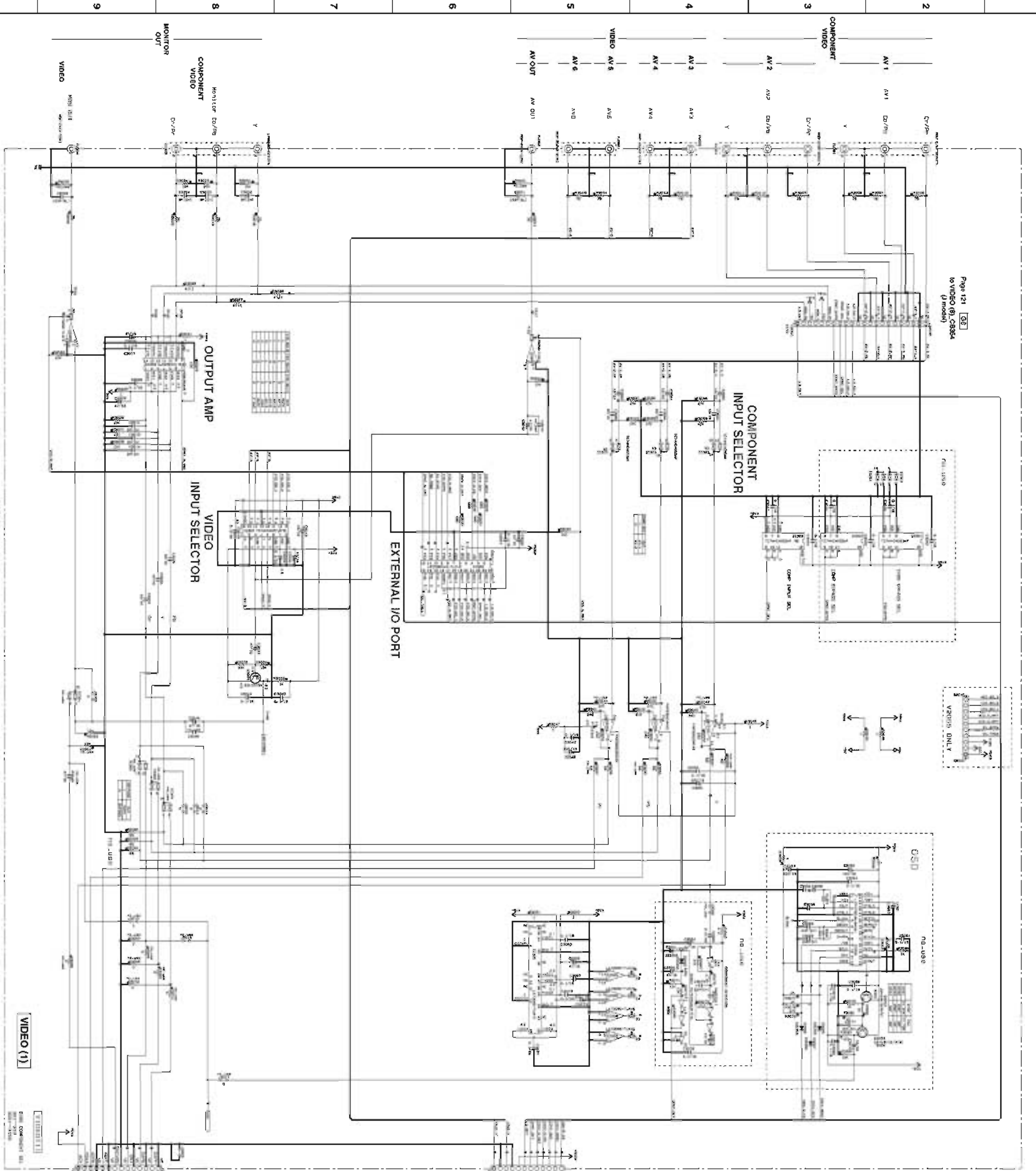

Page 121 (8) to VIDEO (9) CS84 (J model)

Page 118 (8) to OPERATION (9) CS419

OPERATIONAL DATA AT MANUFACTURING POINT

ITEM NO.	TEST ITEM	TEST METHOD	TEST RESULT
1	POWER SUPPLY VOLTAGE	DC VOLTMETER	5.0 ± 0.1V
2	POWER SUPPLY CURRENT	DC AMPMETER	100 ± 5mA
3	VIDEO SIGNAL LEVEL	VIDEO METER	0.7 ± 0.05V
4	VIDEO SIGNAL BANDWIDTH	BANDWIDTH METER	4.2 ± 0.2MHz
5	VIDEO SIGNAL SNR	SNR METER	45 ± 2dB
6	VIDEO SIGNAL DISTORTION	DISTORTION METER	0.5 ± 0.1%
7	VIDEO SIGNAL TIMING	OSCILLOSCOPE	100 ± 5ns
8	VIDEO SIGNAL PHASE	PHASE METER	0 ± 5°
9	VIDEO SIGNAL JITTER	JITTER METER	10 ± 2ps
10	VIDEO SIGNAL RISE TIME	RISE TIME METER	10 ± 2ns

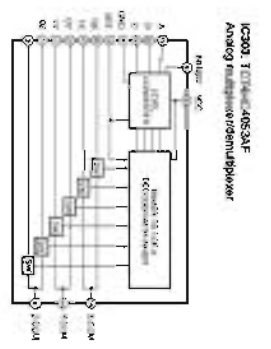

IC206: LA12824-TLLE

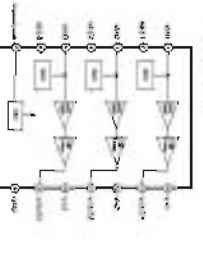

IC207: TC74HC05-HEEL

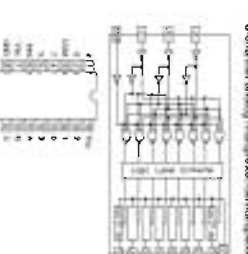

IC208: L07990AA-TLLE

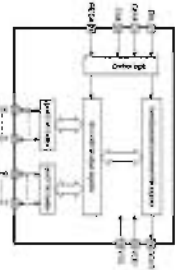

IC210: EMP5E01A1X

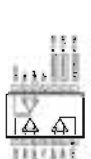

RESISTORS

NO.	VALUE	TYPE	POWER	TEMP.
1	10K	1/4W	0.25	25°C
2	100K	1/4W	0.25	25°C
3	1K	1/4W	0.25	25°C
4	10K	1/4W	0.25	25°C
5	100K	1/4W	0.25	25°C
6	1K	1/4W	0.25	25°C
7	10K	1/4W	0.25	25°C
8	100K	1/4W	0.25	25°C
9	1K	1/4W	0.25	25°C
10	10K	1/4W	0.25	25°C

NOTES

1. All voltages are measured with a 10MΩ/100pF electronic voltmeter.
2. Component values are given in the schematic diagram unless otherwise specified.
3. Components are to be replaced with those of the same type and value as those originally installed.
4. Schematic diagrams are subject to change without notice.

PRODUCTION DATA

REV	DATE	DESCRIPTION	BY	CHKD
1	11/11/00	INITIAL RELEASE
2	01/11/01	REVISION 1
3	03/11/01	REVISION 2
4	05/11/01	REVISION 3
5	07/11/01	REVISION 4
6	09/11/01	REVISION 5
7	11/11/01	REVISION 6
8	01/11/02	REVISION 7
9	03/11/02	REVISION 8
10	05/11/02	REVISION 9
11	07/11/02	REVISION 10
12	09/11/02	REVISION 11
13	11/11/02	REVISION 12
14	01/11/03	REVISION 13
15	03/11/03	REVISION 14
16	05/11/03	REVISION 15
17	07/11/03	REVISION 16
18	09/11/03	REVISION 17
19	11/11/03	REVISION 18
20	01/11/04	REVISION 19
21	03/11/04	REVISION 20
22	05/11/04	REVISION 21
23	07/11/04	REVISION 22
24	09/11/04	REVISION 23
25	11/11/04	REVISION 24
26	01/11/05	REVISION 25
27	03/11/05	REVISION 26
28	05/11/05	REVISION 27
29	07/11/05	REVISION 28
30	09/11/05	REVISION 29
31	11/11/05	REVISION 30
32	01/11/06	REVISION 31
33	03/11/06	REVISION 32
34	05/11/06	REVISION 33
35	07/11/06	REVISION 34
36	09/11/06	REVISION 35
37	11/11/06	REVISION 36
38	01/11/07	REVISION 37
39	03/11/07	REVISION 38
40	05/11/07	REVISION 39
41	07/11/07	REVISION 40
42	09/11/07	REVISION 41
43	11/11/07	REVISION 42
44	01/11/08	REVISION 43
45	03/11/08	REVISION 44
46	05/11/08	REVISION 45
47	07/11/08	REVISION 46
48	09/11/08	REVISION 47
49	11/11/08	REVISION 48
50	01/11/09	REVISION 49
51	03/11/09	REVISION 50
52	05/11/09	REVISION 51
53	07/11/09	REVISION 52
54	09/11/09	REVISION 53
55	11/11/09	REVISION 54
56	01/11/10	REVISION 55
57	03/11/10	REVISION 56
58	05/11/10	REVISION 57
59	07/11/10	REVISION 58
60	09/11/10	REVISION 59
61	11/11/10	REVISION 60
62	01/11/11	REVISION 61
63	03/11/11	REVISION 62
64	05/11/11	REVISION 63
65	07/11/11	REVISION 64
66	09/11/11	REVISION 65
67	11/11/11	REVISION 66
68	01/11/12	REVISION 67
69	03/11/12	REVISION 68
70	05/11/12	REVISION 69
71	07/11/12	REVISION 70
72	09/11/12	REVISION 71
73	11/11/12	REVISION 72
74	01/11/13	REVISION 73
75	03/11/13	REVISION 74
76	05/11/13	REVISION 75
77	07/11/13	REVISION 76
78	09/11/13	REVISION 77
79	11/11/13	REVISION 78
80	01/11/14	REVISION 79
81	03/11/14	REVISION 80
82	05/11/14	REVISION 81
83	07/11/14	REVISION 82
84	09/11/14	REVISION 83
85	11/11/14	REVISION 84
86	01/11/15	REVISION 85
87	03/11/15	REVISION 86
88	05/11/15	REVISION 87
89	07/11/15	REVISION 88
90	09/11/15	REVISION 89
91	11/11/15	REVISION 90
92	01/11/16	REVISION 91
93	03/11/16	REVISION 92
94	05/11/16	REVISION 93
95	07/11/16	REVISION 94
96	09/11/16	REVISION 95
97	11/11/16	REVISION 96
98	01/11/17	REVISION 97
99	03/11/17	REVISION 98
100	05/11/17	REVISION 99
101	07/11/17	REVISION 100

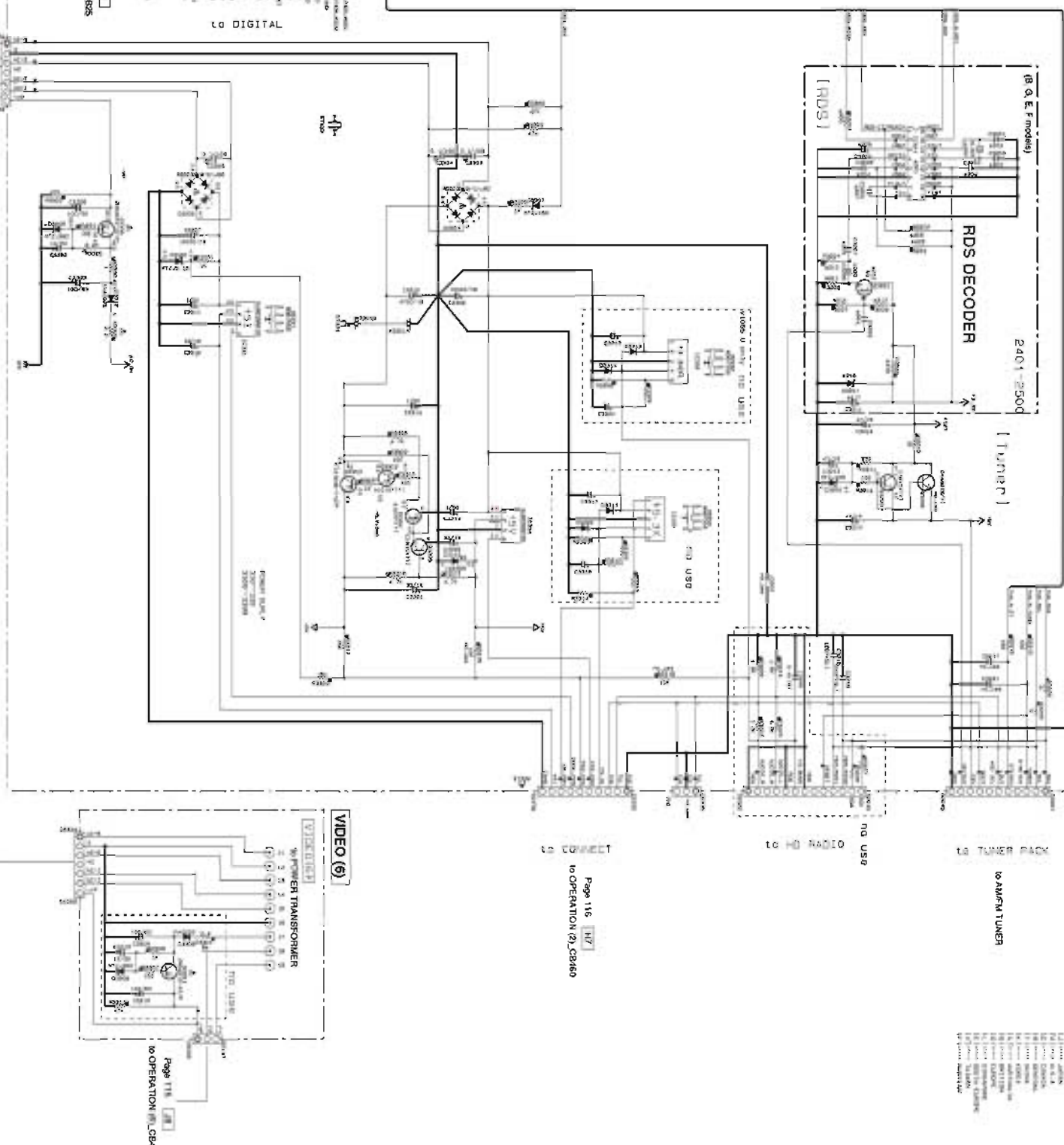
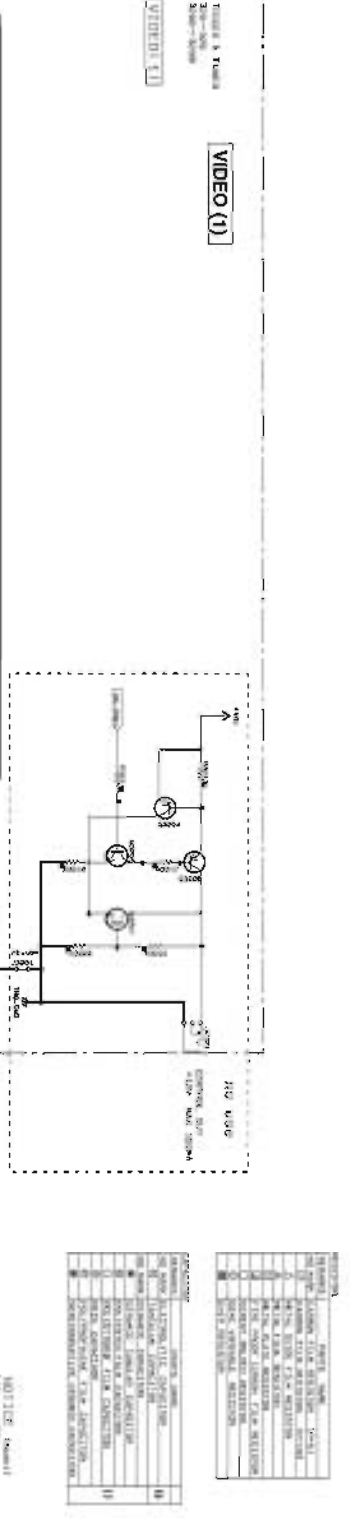
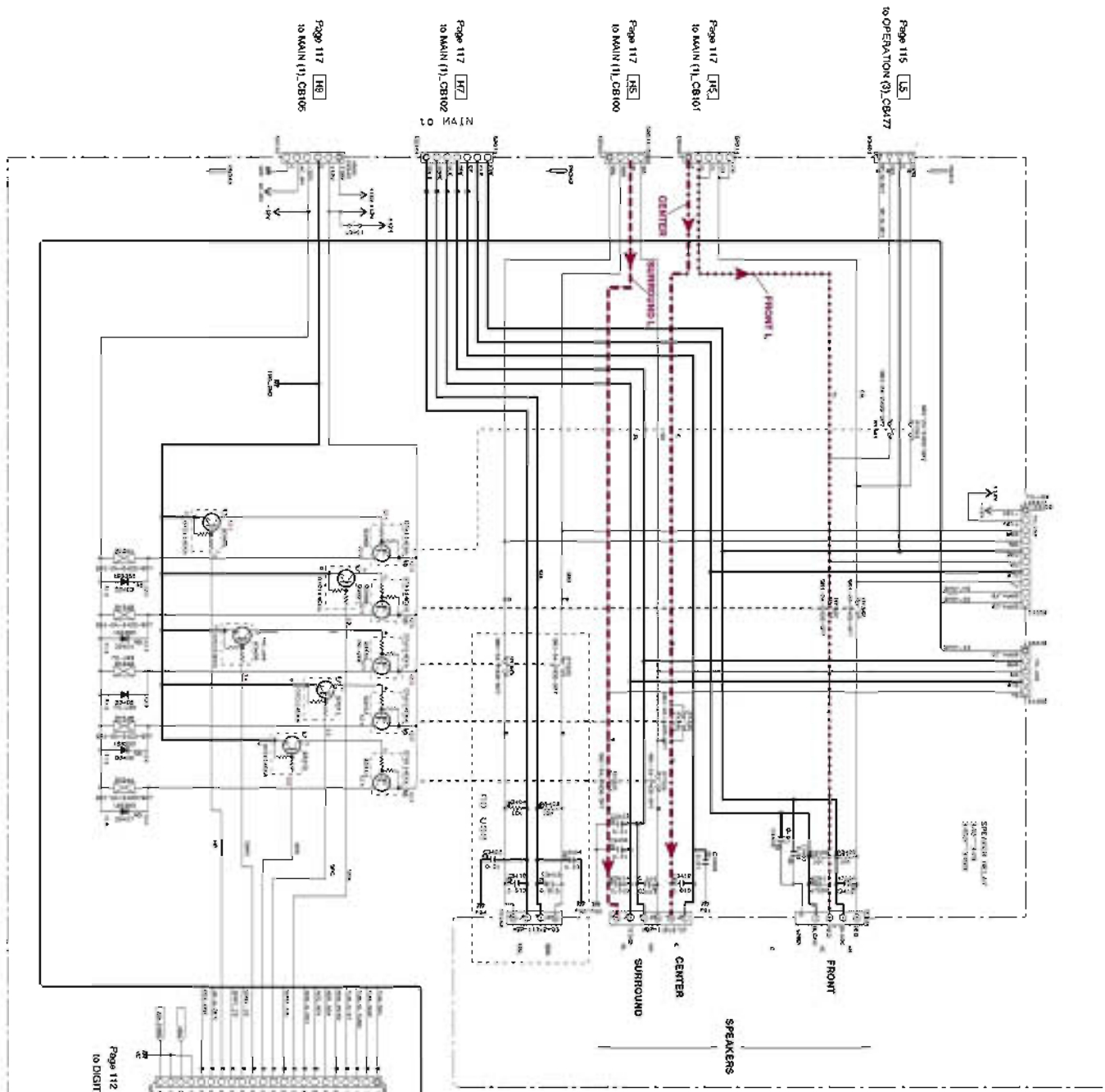

* All voltages are measured with a 10MΩ/100 pF electronic voltmeter.
 * Capacitors having specifications equal to those originally furnished.
 * Schematic diagrams is subject to change without notice.

■ REPLACEMENT PARTS LIST

● ELECTRICAL COMPONENT PARTS

WARNING

- Components having special characteristics are marked Δ and must be replaced with parts having specifications equal to those originally installed.
- Δ 印のある部分は、安全確保部品を示しています。部品の交換が必要な場合、パーツリストに記載されている部品を使用してください。
- 部品価格ランクは、予告なく変更することがあります。

ABBREVIATIONS IN THIS LIST ARE AS FOLLOWS:

C.A.EL.CHP	: CHIP ALUMI.ELECTROLYTIC CAP	L.EMIT	: LIGHT EMITTING MODULE
C.CE	: CERAMIC CAP	LED.DSPLY	: LED DISPLAY
C.CE.ARRAY	: CERAMIC CAP ARRAY	LED.INFRD	: LED, INFRARED
C.CE.CHP	: CHIP CERAMIC CAP	MODUL.RF	: MODULATOR, RF
C.CE.ML	: MULTILAYER CERAMIC CAP	PHOT.CPL	: PHOTO COUPLER
C.CE.M.CHP	: CHIP MULTILAYER CERAMIC CAP	PHOT.INTR	: PHOTO INTERRUPTER
C.CE.SAFTY	: RECOGNIZED CERAMIC CAP	PHOT.RFLCT	: PHOTO REFLECTOR
C.CE.TUBLR	: CERAMIC TUBULAR CAP	PIN.TEST	: PIN, TEST POINT
C.CE.SMI	: SEMI CONDUCTIVE CERAMIC CAP	PLST.RIVET	: PLASTIC RIVET
C.EL	: ELECTROLYTIC CAP	R.ARRAY	: RESISTOR ARRAY
C.MICA	: MICA CAP	R.CAR.	: CARBON RESISTOR
C.ML.FLM	: MULTILAYER FILM CAP	R.CAR.CHP	: CHIP RESISTOR
C.MP	: METALLIZED PAPER CAP	R.CAR.FP	: FLAME PROOF CARBON RESISTOR
C.MYLAR	: MYLAR FILM CAP	R.FUS	: FUSABLE RESISTOR
C.MYLAR.ML	: MULTILAYER MYLAR FILM CAP	R.MTL.CHP	: CHIP METAL FILM RESISTOR
C.PAPER	: PAPER CAPACITOR	R.MTL.FLM	: METAL FILM RESISTOR
C.PLS	: POLYSTYRENE FILM CAP	R.MTL.OXD	: METAL OXIDE FILM RESISTOR
C.POL	: POLYESTER FILM CAP	R.MTL.PLAT	: METAL PLATE RESISTOR
C.POLY	: POLYETHYLENE FILM CAP	RSNR.CE	: CERAMIC RESONATOR
C.PP	: POLYPROPYLENE FILM CAP	RSNR.CRYS	: CRYSTAL RESONATOR
C.TNTL	: TANTALUM CAP	R.TW.CEM	: TWIN CEMENT FIXED RESISTOR
C.TNTL.CHP	: CHIP TANTALUM CAP	R.CEMENT	: CEMENT RESISTOR
C.TRIM	: TRIMMER CAP	SCR.BND.HD	: BIND HEAD B-TIGHT SCREW
CN	: CONNECTOR	SCR.BW.HD	: BW HEAD TAPPING SCREW
CN.BS.PIN	: CONNECTOR, BASE PIN	SCR.CUP	: CUP TIGHT SCREW
CN.CANNON	: CONNECTOR, CANNON	SCR.TERM	: SCREW TERMINAL
CN.DIN	: CONNECTOR, DIN	SCR.TR	: SCREW, TRANSISTOR
CN.FLAT	: CONNECTOR, FLAT CABLE	SUPRT.PCB	: SUPPORT, P.C.B.
CN.POST	: CONNECTOR, BASE POST	SURG.PRTCT	: SURGE PROTECTOR
COIL.MX.AM	: COIL, AM MIX	SW.TACT	: TACT SWITCH
COIL.AT.FM	: COIL, FM ANTENNA	SW.LEAF	: LEAF SWITCH
COIL.DT.FM	: COIL, FM DETECT	SW.LEVER	: LEVER SWITCH
COIL.MX.FM	: COIL, FM MIX	SW.MICRO	: MICRO SWITCH
COIL.OUTPT	: OUTPUT COIL	SW.PUSH	: PUSH SWITCH
DIOD.ARRAY	: DIODE ARRAY	SW.RT.ENC	: ROTARY ENCODER
DIODE.BRG	: DIODE BRIDGE	SW.RT.MTR	: ROTARY SWITCH WITH MOTOR
DIODE.CHP	: CHIP DIODE	SW.RT	: ROTARY SWITCH
DIODE.VAR	: VARACTOR DIODE	SW.SLIDE	: SLIDE SWITCH
DIOD.Z.CHP	: CHIP ZENER DIODE	TERM.SP	: SPEAKER TERMINAL
DIODE.ZENR	: ZENER DIODE	TERM.WRAP	: WRAPPING TERMINAL
DSCR.CE	: CERAMIC DISCRIMINATOR	THRMST.CHP	: CHIP THERMISTOR
FER.BEAD	: FERRITE BEADS	TR.CHP	: CHIP TRANSISTOR
FER.CORE	: FERRITE CORE	TR.DGT	: DIGITAL TRANSISTOR
FET.CHP	: CHIP FET	TR.DGT.CHP	: CHIP DIGITAL TRANSISTOR
FL.DSPLY	: FLUORESCENT DISPLAY	TRANS	: TRANSFORMER
FLTR.CE	: CERAMIC FILTER	TRANS.PULS	: PULSE TRANSFORMER
FLTR.COMB	: COMB FILTER MODULE	TRANS.PWR	: POWER TRANSFORMER ASS'Y
FLTR.LC.RF	: LC FILTER, EMI	TUNER.AM	: TUNER PACK, AM
GND.MTL	: GROUND PLATE	TUNER.FM	: TUNER PACK, FM
GND.TERM	: GROUND TERMINAL	TUNER.PK	: FRONT-END TUNER PACK
HOLDER.FUS	: FUSE HOLDER	VR	: ROTARY POTENTIOMETER
IC.PRTCT	: IC PROTECTOR	VR.MTR	: POTENTIOMETER WITH MOTOR
JUMPER.CN	: JUMPER CONNECTOR	VR.SW	: POTENTIOMETER WITH ROTARY SW
JUMPER.TST	: JUMPER, TEST POINT	VR.SLIDE	: SLIDE POTENTIOMETER
L.DTCT	: LIGHT DETECTING MODULE	VR.TRIM	: TRIMMER POTENTIOMETER

P.C.B. DIGITAL

Ref No.	Part No.	Description	Remarks	Markets	部 品 名	ランク	
*	WQ925600	P. C. B.	DIGITAL	V465	JUCRTKAL	PCB DIGITAL	
*	WQ925800	P. C. B.	DIGITAL	6240	UCTK	PCB DIGITAL	
*	WQ925700	P. C. B.	DIGITAL	V465	BGEF	PCB DIGITAL	
*	WQ925900	P. C. B.	DIGITAL	6240	EF	PCB DIGITAL	
CB1-4	WM462600	CN. HDMI	19P SE			コネクタ HDMI	04
CB6	WM462600	CN. HDMI	19P SE			コネクタ HDMI	04
CB7	LB918040	CN. BS. PIN	4P			ベース付ポスト	01
CB20	VP082900	CN. BS. PIN	25P			FFCコネクタ	02
CB22	VK024700	CN. BS. PIN	3P			ワイヤートラップ	01
CB23	VK025600	CN. BS. PIN	12P			ワイヤートラップ	01
CB24	VF728300	CN	6P			コネクタ	01
CB25	VQ045200	CN. BS. PIN	22P			FFCコネクタ	01
CB27	VQ047200	CN. BS. PIN	9P			FFCコネクタ	01
CB61-63	V9356900	CN. JE	19P SE			JEコネクタプラグ	
C1-2	US135100	C. CE. CHP	0.1uF 16V			チップセラコン	01
C3-4	WD758300	C. CE. CHP	10uF 10V			チップセラコン	01
C5-14	US135100	C. CE. CHP	0.1uF 16V			チップセラコン	01
C15-24	US063100	C. CE. CHP	1000pF 50V B			チップセラコン	01
C25	US135100	C. CE. CHP	0.1uF 16V			チップセラコン	01
C27	US061120	C. CE. CHP	12pF 50V B			チップセラコン	01
C28	US061150	C. CE. CHP	15pF 50V B			チップセラコン	01
C29	US135100	C. CE. CHP	0.1uF 16V			チップセラコン	01
C30	WD758300	C. CE. CHP	10uF 10V			チップセラコン	01
C31-32	US135100	C. CE. CHP	0.1uF 16V			チップセラコン	01
C33	US063100	C. CE. CHP	1000pF 50V B			チップセラコン	01
C34	US135100	C. CE. CHP	0.1uF 16V			チップセラコン	01
C35	WD758300	C. CE. CHP	10uF 10V			チップセラコン	01
C36	US135100	C. CE. CHP	0.1uF 16V			チップセラコン	01
C37	US063100	C. CE. CHP	1000pF 50V B			チップセラコン	01
C38-40	WD758300	C. CE. CHP	10uF 10V			チップセラコン	01
C41-43	US063100	C. CE. CHP	1000pF 50V B			チップセラコン	01
C44-46	US135100	C. CE. CHP	0.1uF 16V			チップセラコン	01
C47	WD758300	C. CE. CHP	10uF 10V			チップセラコン	01
C48	US135100	C. CE. CHP	0.1uF 16V			チップセラコン	01
C50	WD758300	C. CE. CHP	10uF 10V			チップセラコン	01
C51	US135100	C. CE. CHP	0.1uF 16V			チップセラコン	01
C53-54	US135100	C. CE. CHP	0.1uF 16V			チップセラコン	01
C55-56	WD758300	C. CE. CHP	10uF 10V			チップセラコン	01
C57	US063100	C. CE. CHP	1000pF 50V B			チップセラコン	01
C58	WD758300	C. CE. CHP	10uF 10V			チップセラコン	01
C59-61	US135100	C. CE. CHP	0.1uF 16V			チップセラコン	01
C62	WG251600	C. CE. CHP	4.7uF 6.3V			チップセラコン	01
C64-66	US135100	C. CE. CHP	0.1uF 16V			チップセラコン	01
C67	WG251600	C. CE. CHP	4.7uF 6.3V			チップセラコン	01
C69	UF027470	C. EL. CHP	47uF 10V			チップケミコン	01
C71-72	US135100	C. CE. CHP	0.1uF 16V			チップセラコン	01
C73-74	WJ344400	C. CE. CHP	22uF 6.3V			チップセラコン	01
C75	WD758300	C. CE. CHP	10uF 10V			チップセラコン	01
C76	US135100	C. CE. CHP	0.1uF 16V			チップセラコン	01
C77	WD758300	C. CE. CHP	10uF 10V			チップセラコン	01
C78	US135100	C. CE. CHP	0.1uF 16V			チップセラコン	01
C79-80	US062220	C. CE. CHP	220pF 50V B			チップセラコン	01
C81-82	US135100	C. CE. CHP	0.1uF 16V			チップセラコン	01
C83	US063330	C. CE. CHP	3300pF 50V B			チップセラコン	01
C84	US063470	C. CE. CHP	4700pF 50V B			チップセラコン	01
C85	US063120	C. CE. CHP	1200pF 50V B			チップセラコン	01
C86	US135100	C. CE. CHP	0.1uF 16V			チップセラコン	01

* New Parts * 新規部品

P.C.B. DIGITAL

Ref No.	Part No.	Description	Remarks	Markets	部 品 名	ランク	
C87	US063120	C. CE. CHP	1200pF	50V B		チップセラコン	01
C88-90	US135100	C. CE. CHP	0.1uF	16V		チップセラコン	01
C91-92	WD758300	C. CE. CHP	10uF	10V		チップセラコン	01
C93	US135100	C. CE. CHP	0.1uF	16V		チップセラコン	01
C94	WD758300	C. CE. CHP	10uF	10V		チップセラコン	01
C97-101	US135100	C. CE. CHP	0.1uF	16V		チップセラコン	01
C102	UR267470	C. EL	47uF	50V		ケミコン	01
C103	WG251600	C. CE. CHP	4.7uF	6.3V		チップセラコン	01
C104	US135100	C. CE. CHP	0.1uF	16V		チップセラコン	01
C105	WH772100	C. EL	1000uF	10V		ケミコン	04
C106-124	US135100	C. CE. CHP	0.1uF	16V		チップセラコン	01
C136	US135100	C. CE. CHP	0.1uF	16V		チップセラコン	01
C137-138	US062470	C. CE. CHP	470pF	50V B		チップセラコン	01
C200	UR837330	C. EL	33uF	16V		ケミコン	01
C201	US135100	C. CE. CHP	0.1uF	16V		チップセラコン	01
C202	US064100	C. CE. CHP	0.01uF	50V B		チップセラコン	01
C204-205	US064100	C. CE. CHP	0.01uF	50V B		チップセラコン	01
C207-211	US064100	C. CE. CHP	0.01uF	50V B		チップセラコン	01
C212	US135100	C. CE. CHP	0.1uF	16V		チップセラコン	01
C214	US135100	C. CE. CHP	0.1uF	16V		チップセラコン	01
C215-216	US064100	C. CE. CHP	0.01uF	50V B		チップセラコン	01
C217	US135100	C. CE. CHP	0.1uF	16V		チップセラコン	01
C218-219	US064100	C. CE. CHP	0.01uF	50V B		チップセラコン	01
C220-225	US135100	C. CE. CHP	0.1uF	16V		チップセラコン	01
C226	WG251600	C. CE. CHP	4.7uF	6.3V		チップセラコン	01
C228-229	WG251600	C. CE. CHP	4.7uF	6.3V		チップセラコン	01
C231	US135100	C. CE. CHP	0.1uF	16V		チップセラコン	01
C234-238	US046100	C. CE. CHP	1uF	25V		チップセラコン	01
C239-242	US062100	C. CE. CHP	100pF	50V B		チップセラコン	01
C243	US064100	C. CE. CHP	0.01uF	50V B		チップセラコン	01
C244-254	US135100	C. CE. CHP	0.1uF	16V		チップセラコン	01
C402-403	US064100	C. CE. CHP	0.01uF	50V B		チップセラコン	01
C410-411	US135100	C. CE. CHP	0.1uF	16V		チップセラコン	01
C412	US035100	C. CE. CHP	0.1uF	16V B		チップセラコン	01
C413-414	US135100	C. CE. CHP	0.1uF	16V		チップセラコン	01
C415	US044220	C. CE. CHP	0.022uF	25V B		チップセラコン	01
C416	US062100	C. CE. CHP	100pF	50V B		チップセラコン	01
C418	US062220	C. CE. CHP	220pF	50V B		チップセラコン	01
C419	US135100	C. CE. CHP	0.1uF	16V		チップセラコン	01
C420	US062220	C. CE. CHP	220pF	50V B		チップセラコン	01
C422	US062220	C. CE. CHP	220pF	50V B		チップセラコン	01
C424-425	US135100	C. CE. CHP	0.1uF	16V		チップセラコン	01
C426	US062220	C. CE. CHP	220pF	50V B		チップセラコン	01
C430	UR067470	C. EL	47uF	50V		ケミコン	01
C431	US062100	C. CE. CHP	100pF	50V B		チップセラコン	01
C432-433	US062220	C. CE. CHP	220pF	50V B		チップセラコン	01
C434-436	US135100	C. CE. CHP	0.1uF	16V		チップセラコン	01
C437-438	US062100	C. CE. CHP	100pF	50V B		チップセラコン	01
C439	US061100	C. CE. CHP	10pF	50V B		チップセラコン	01
C440	US060800	C. CE. CHP	8pF	50V B		チップセラコン	01
C441-442	US062390	C. CE. CHP	390pF	50V B		チップセラコン	01
C445-446	UR837100	C. EL	10uF	16V		ケミコン	01
C447-448	US135100	C. CE. CHP	0.1uF	16V		チップセラコン	01
C449-450	UR237470	C. EL	47uF	16V		ケミコン	01
C451	US062100	C. CE. CHP	100pF	50V B		チップセラコン	01
C452	UR067100	C. EL	10uF	50V		ケミコン	01
C453	US126100	C. CE. CHP	1uF	10V		チップセラコン	01

* New Parts * 新規部品

P.C.B. DIGITAL

Ref No.	Part No.	Description	Remarks	Markets	部 品 名	ランク	
C454-472	US135100	C. CE. CHP	0. 1uF	16V		チップセラコン	01
C473	US062680	C. CE. CHP	680pF	50V B		チップセラコン	01
C474-476	US135100	C. CE. CHP	0. 1uF	16V		チップセラコン	01
C477	WG251600	C. CE. CHP	4. 7uF	6. 3V		チップセラコン	01
C478-484	US135100	C. CE. CHP	0. 1uF	16V		チップセラコン	01
C485	WG251600	C. CE. CHP	4. 7uF	6. 3V		チップセラコン	01
C486	US135100	C. CE. CHP	0. 1uF	16V		チップセラコン	01
C488-489	UU297220	C. EL	22uF	100V		ケミコン	01
C491-493	US135100	C. CE. CHP	0. 1uF	16V		チップセラコン	01
C494-496	US063100	C. CE. CHP	1000pF	50V B		チップセラコン	01
C497-498	US135100	C. CE. CHP	0. 1uF	16V		チップセラコン	01
C499-502	US063100	C. CE. CHP	1000pF	50V B		チップセラコン	01
C503-519	US135100	C. CE. CHP	0. 1uF	16V		チップセラコン	01
C600	UU267220	C. EL	22uF	50V		ケミコン	
C601-603	US135100	C. CE. CHP	0. 1uF	16V		チップセラコン	01
C604-605	US064100	C. CE. CHP	0. 01uF	50V B		チップセラコン	01
C606	UR067100	C. EL	10uF	50V		ケミコン	01
C608-609	US135100	C. CE. CHP	0. 1uF	16V		チップセラコン	01
C610	US126100	C. CE. CHP	1uF	10V		チップセラコン	01
C611	US062100	C. CE. CHP	100pF	50V B		チップセラコン	01
C612	UR067100	C. EL	10uF	50V		ケミコン	01
C613-614	US126100	C. CE. CHP	1uF	10V		チップセラコン	01
C619	US135100	C. CE. CHP	0. 1uF	16V		チップセラコン	01
C620	UR067470	C. EL	47uF	50V		ケミコン	01
C622	UR067100	C. EL	10uF	50V		ケミコン	01
C623	US135100	C. CE. CHP	0. 1uF	16V		チップセラコン	01
C624	UU267100	C. EL	10uF	50V		ケミコン	01
C625	US135100	C. CE. CHP	0. 1uF	16V		チップセラコン	01
C626	UR067100	C. EL	10uF	50V		ケミコン	01
C627-628	WJ603600	C. MYLAR	820pF	50V J		マイラーコン	01
C633-634	UR067100	C. EL	10uF	50V		ケミコン	01
C635-642	US062100	C. CE. CHP	100pF	50V B		チップセラコン	01
D2	WE674800	DIODE	AVRL161A1R1NTB			チップバリスタ	01
D11-14	WE674800	DIODE	AVRL161A1R1NTB			チップバリスタ	01
D23-26	WE674800	DIODE	AVRL161A1R1NTB			チップバリスタ	01
D35-38	WE674800	DIODE	AVRL161A1R1NTB			チップバリスタ	01
D47-49	WE674800	DIODE	AVRL161A1R1NTB			チップバリスタ	01
D60-61	WE674800	DIODE	AVRL161A1R1NTB			チップバリスタ	01
D62	VV220700	DIODE. SHOT	RB501V-40			ショットキーダイオード	01
D63-64	V6267600	DIODE	RB051L-40			ダイオード	01
D65	WE674800	DIODE	AVRL161A1R1NTB			チップバリスタ	01
D200-204	VU990900	DIODE. ZENR	MAZ8033GHL 3. 4V			ツェナーダイオード	01
D403-404	VT332900	DIODE	1SS355			ダイオード	01
D600	VT332900	DIODE	1SS355			ダイオード	01
D602-603	VT332900	DIODE	1SS355			ダイオード	01
IC2	XZ287A00	IC	SN74LVC245APWR			ロジック IC	02
IC5	X7195A00	IC	R1172S121D-E2-F			電源 IC	04
IC10	X7741A00	IC	NJM2867F3-05 (TE1)			電源 IC	02
IC11	X0199B00	IC	TC74VHC157FT (EL, K)			ロジック IC	01
* IC13	YA255A00	IC	R1172H501D-T1-F			電源 IC	
IC20	X8328A00	IC. CPU	M30878FJBG	unwritten		IC CPU	10
IC21	X8194A00	IC	R1172H331D-T1-F			電源 IC	03
* IC22	YA398A00	IC. MEMORY	LE25LA322M-TLM-E			メモリ IC	
* IC41	YA399A00	IC	LC89058WD-E			IC	
IC43	X7378A00	IC	NJM4565M (TE1)			アンプ IC	01
IC46	X0199B00	IC	TC74VHC157FT (EL, K)			ロジック IC	01
IC47	X7195A00	IC	R1172S121D-E2-F			電源 IC	04

* New Parts * 新規部品

P.C.B. DIGITAL and P.C.B. OPERATION
--

Ref No.	Part No.	Description	Remarks	Markets	部 品 名	ランク
* IC48	X9626B00	IC. MEMORY	K4S641632N-LC60000		メモリ IC 64M	
* IC49	YA540C00	IC. MEMORY	MX29LV160DBT1-70G	written	メモリ IC 16M	
IC50	XR680A00	IC	TC7SH08FU (TE85L, JF		ロジック IC	01
IC62	X0199B00	IC	TC74VHC157FT (EL, K)		ロジック IC	01
IC63	XS534A00	IC	NJM78M05DL1A		電源 IC	02
IC65	X7355A00	IC	PCM1680DBQR		IC	07
IC66	X7357A00	IC	PCM1803DBR		IC	04
IC67	X3586B00	IC	TC74VHCT08AFT EL, K		ロジック IC	01
PN20-22	V9637500	PIN	L=70 #18		スタイルピン	
Q1-8	VQ986700	TR	2SC4081 T106		トランジスタ	01
* Q200	WQ381000	FET	MCH6336-TL-E		MOS FET	
Q201-202	VV655300	TR. DGT	DTA144EKA		デジタルトランジスタ	01
Q205-209	VR936300	TR	2SA1576A T106		トランジスタ	01
* Q400	WQ381000	FET	MCH6336-TL-E		MOS FET	
Q401	VV655300	TR. DGT	DTA144EKA		デジタルトランジスタ	01
* Q402	WQ381000	FET	MCH6336-TL-E		MOS FET	
Q403	VV655000	TR. DGT	DTA114EKA		デジタルトランジスタ	01
Q404	VV655300	TR. DGT	DTA144EKA		デジタルトランジスタ	01
R88	WJ682800	R. MTL. FLM	2.2Ω 1W		金属被膜抵抗	01
R201		R. CHP	0Ω 1/16W J	V465	チップ抵抗	01
R201		R. CHP	1KΩ 1/16W J	6240	チップ抵抗	01
R466-467	HV753220	R. CAR. FP	2.2Ω 1/4W		不燃化カーボン抵抗	01
R601	WJ683800	R. MTL. FLM	15Ω 1W		金属被膜抵抗	
R607	HV753220	R. CAR. FP	2.2Ω 1/4W		不燃化カーボン抵抗	01
* ST1-2	WR364700	SCR. TERM	M3		スクリューターミナル	
XL1	WR725300	RSNR. CRYST	27MHz		水晶振動子	03
XL20	WF997400	RSNR. CE	20MHz		セラミック振動子	02
XL42	V3625700	RSNR. CRYST	24.576MHz		水晶振動子	03
* WQ923800		P. C. B.	OPERATION		PCB OPERATION	
CB401	VQ045400	CN. BS. PIN	25P		FFCコネクタ	03
CB402	VQ044400	CN. BS. PIN	9P		FFCコネクタ	01
CB451	VQ961100	CN. BS. PIN	8P		ハウジング	01
CB452	V9357000	CN	19P TE		JEコネクタ	
CB454	VQ962100	CN. BS. PIN	18P		ハウジング	03
CB455	V9357000	CN	19P TE		JEコネクタ	
CB456	VQ961800	CN. BS. PIN	15P		ハウジング	01
CB457	VQ961400	CN. BS. PIN	11P		ハウジング	03
CB458	V9357000	CN	19P TE		JEコネクタ	
CB459	VQ963300	CN. BS. PIN	12P		ウエハー	01
CB460	VQ963100	CN. BS. PIN	10P		ウエハー	01
CB461	VQ044400	CN. BS. PIN	9P		FFCコネクタ	01
CB477	VB858300	CN. BS. PIN	4P		コネクタベースポスト	01
C4001	US063100	C. CE. CHP	1000pF 50V B		チップセラコン	01
C4002	US065100	C. CE. CHP	0.1uF 50V B		チップセラコン	01
C4003	UR067100	C. EL	10uF 50V		ケミコン	01
C4004	US064100	C. CE. CHP	0.01uF 50V B		チップセラコン	01
C4005	UR837220	C. EL	22uF 16V		ケミコン	01
C4006	US062100	C. CE. CHP	100pF 50V B		チップセラコン	01
C4007	UR257470	C. EL	47uF 35V		ケミコン	01
C4008	US061330	C. CE. CHP	33pF 50V B		チップセラコン	01
C4009-4010	UR267220	C. EL	22uF 50V		ケミコン	01
C4011	UR067100	C. EL	10uF 50V		ケミコン	01
C4012-4013	US135100	C. CE. CHP	0.1uF 16V		チップセラコン	01
C4015	UR268220	C. EL	220uF 50V		ケミコン	01

* New Parts * 新規部品

P.C.B. OPERATION

Ref No.	Part No.	Description	Remarks	Markets	部 品 名	ランク
C4016	UM388330	C. EL	330uF 6.3V		ケミコン	01
C4017	US135100	C. CE. CHP	0.1uF 16V		チップセラコン	01
C4018	US061680	C. CE. CHP	68pF 50V B		チップセラコン	01
C4019	US065100	C. CE. CHP	0.1uF 50V B		チップセラコン	01
C4020-4021	US135100	C. CE. CHP	0.1uF 16V		チップセラコン	01
C4022	US064100	C. CE. CHP	0.01uF 50V B		チップセラコン	01
C4023-4024	US063100	C. CE. CHP	1000pF 50V B		チップセラコン	01
C4025-4026	US065100	C. CE. CHP	0.1uF 50V B		チップセラコン	01
C4027	US135100	C. CE. CHP	0.1uF 16V		チップセラコン	01
C4028	US062100	C. CE. CHP	100pF 50V B		チップセラコン	01
C4030	US062100	C. CE. CHP	100pF 50V B		チップセラコン	01
C4031	US062470	C. CE. CHP	470pF 50V B		チップセラコン	01
C4032	US135100	C. CE. CHP	0.1uF 16V		チップセラコン	01
C4033	US063100	C. CE. CHP	1000pF 50V B		チップセラコン	01
C4034	UM417100	C. EL	10uF 50V		ケミコン	01
C4035	US135100	C. CE. CHP	0.1uF 16V		チップセラコン	01
C4036	US063100	C. CE. CHP	1000pF 50V B		チップセラコン	01
C4037	US064100	C. CE. CHP	0.01uF 50V B		チップセラコン	01
C4212	US062100	C. CE. CHP	100pF 50V B		チップセラコン	01
C4213	UR067100	C. EL	10uF 50V		ケミコン	01
C4214	UR037100	C. EL	10uF 16V		ケミコン	01
C4215	WJ603500	C. MYLAR	680pF 50V		マイラーコン	
C4216	US135100	C. CE. CHP	0.1uF 16V		チップセラコン	01
C4217	UR267470	C. EL	47uF 50V		ケミコン	01
C4218	US135100	C. CE. CHP	0.1uF 16V		チップセラコン	01
C4219	UR267470	C. EL	47uF 50V		ケミコン	01
C4220	WJ603500	C. MYLAR	680pF 50V		マイラーコン	
C4221	UR037100	C. EL	10uF 16V		ケミコン	01
C4222	UR067100	C. EL	10uF 50V		ケミコン	01
C4223-4224	US062100	C. CE. CHP	100pF 50V B		チップセラコン	01
C4225	UR067100	C. EL	10uF 50V		ケミコン	01
C4226	UR037100	C. EL	10uF 16V		ケミコン	01
C4227	WJ603500	C. MYLAR	680pF 50V		マイラーコン	
C4228-4229	US135100	C. CE. CHP	0.1uF 16V		チップセラコン	01
C4230	WJ605800	C. MYLAR	0.047uF 50V J		マイラーコン	01
C4231-4232	UR067100	C. EL	10uF 50V		ケミコン	01
C4233	WJ604700	C. MYLAR	6800pF 50V		マイラーコン	
C4234	US062100	C. CE. CHP	100pF 50V B		チップセラコン	01
C4235	UR067100	C. EL	10uF 50V		ケミコン	01
C4236	UR037100	C. EL	10uF 16V		ケミコン	01
C4237	WJ603500	C. MYLAR	680pF 50V		マイラーコン	
C4238-4239	US135100	C. CE. CHP	0.1uF 16V		チップセラコン	01
C4240	WJ603500	C. MYLAR	680pF 50V		マイラーコン	
C4241	UR037100	C. EL	10uF 16V		ケミコン	01
C4242	UR067100	C. EL	10uF 50V		ケミコン	01
C4243-4244	US062100	C. CE. CHP	100pF 50V B		チップセラコン	01
C4245	UR067100	C. EL	10uF 50V		ケミコン	01
C4246	UR037100	C. EL	10uF 16V		ケミコン	01
C4247	WJ603500	C. MYLAR	680pF 50V		マイラーコン	
C4248-4249	US135100	C. CE. CHP	0.1uF 16V		チップセラコン	01
C4250	WJ603500	C. MYLAR	680pF 50V		マイラーコン	
C4251	UR037100	C. EL	10uF 16V		ケミコン	01
C4252	UR067100	C. EL	10uF 50V		ケミコン	01
C4253	US062100	C. CE. CHP	100pF 50V B		チップセラコン	01
C4403	WJ604300	C. MYLAR	3300pF 50V		マイラーコン	
C4406	WJ604300	C. MYLAR	3300pF 50V		マイラーコン	
C4407	US064100	C. CE. CHP	0.01uF 50V B		チップセラコン	01

* New Parts * 新規部品

P.C.B. OPERATION and P.C.B. MAIN

Ref No.	Part No.	Description	Remarks	Markets	部 品 名	ランク
C4408-4409	US063680	C. CE. CHP	6800pF 50V B		チップセラコン	01
C4412	US135100	C. CE. CHP	0.1uF 16V		チップセラコン	01
C4414	US063100	C. CE. CHP	1000pF 50V B		チップセラコン	01
C4416	US135100	C. CE. CHP	0.1uF 16V		チップセラコン	01
D4001-4002	VT332900	DIODE	1SS355		ダイオード	01
D4003	VU171900	DIODE. ZENR	UDZ5.1B 5.1V		ツェナーダイオード	01
D4004-4005	VT332900	DIODE	1SS355		ダイオード	01
D4006-4007	VU991900	DIODE. ZENR	MAZ8043GHL 4.4V		ツェナーダイオード	01
D4009	WR095700	LED	8224-10SDRD/S530A3		LED	
D4010	VT332900	DIODE	1SS355		ダイオード	01
D4012	VT332900	DIODE	1SS355		ダイオード	01
D4401-4402	VT332900	DIODE	1SS355		ダイオード	01
D4403	VU995000	DIODE. ZENR	MAZ8091GML 9.1V		ツェナーダイオード	
D4406-4407	VT332900	DIODE	1SS355		ダイオード	01
D4409	VT332900	DIODE	1SS355		ダイオード	01
D4411	VT332900	DIODE	1SS355		ダイオード	01
IC401	X7378A00	IC	NJM4565M		アンプIC	01
IC402	X6386A00	IC	M66003-0131FP		IC	07
IC451-454	X7378A00	IC	NJM4565M		アンプIC	01
JK401	WC814400	JACK. MNI	JY-3554-01-130		ミニジャック	
JK471	WJ117400	JACK. MINI	OPTIMIZER MIC		ミニジャック	02
JK472	V9408200	JACK. PHONE	MSJ-064-05B GR		ホーンジャック	03
PJ472	WJ117500	JACK. PIN	3P		ピンジャック	03
PN451	V9637500	PIN	L=70 #18		スタイルピン	
PN472	V9637500	PIN	L=70 #18		スタイルピン	
Q4001-4003	WC529400	TR	KTC3875S Y GR RTK		トランジスタ	01
Q4004	VV655400	TR. DGT	DTC114EKA		デジタルトランジスタ	01
Q4005	WC397700	TR	2N5401C-AT		トランジスタ	
Q4006-4009	WC529400	TR	KTC3875S Y GR RTK		トランジスタ	01
Q4011-4012	WC529400	TR	KTC3875S Y GR RTK		トランジスタ	01
R4208-4209	HV753220	R. CAR. FP	2.2Ω 1/4W		不燃化カーボン抵抗	01
R4413-4414	WJ685600	R. MTL. FLM	470Ω 1W J		金属被膜抵抗	01
ST451	WA789600	SCR. TERM	M3		スクリューターミナル	
ST471	WA789700	SCR. TERM	D3.5		スクリューターミナル	01
SW401-406	WD483100	SW. TACT	SKRGAAD010		タクト SW	01
SW408-409	WD483100	SW. TACT	SKRGAAD010		タクト SW	01
SW411	WD483100	SW. TACT	SKRGAAD010		タクト SW	01
SW413-414	WD483100	SW. TACT	SKRGAAD010		タクト SW	01
SW416	WD483100	SW. TACT	SKRGAAD010		タクト SW	01
SW419-420	WD483100	SW. TACT	SKRGAAD010		タクト SW	01
SW422-423	WD483100	SW. TACT	SKRGAAD010		タクト SW	01
SW425-427	WD483100	SW. TACT	SKRGAAD010		タクト SW	01
SW443	V9597100	SW. RT. ENC	EC12E2460802		ロータリーエンコーダ	04
SW471	WD483100	SW. TACT	SKRGAAD010		タクト SW	01
* U4001	WQ600700	L. DTCT	SM3385VMH6		リモコン受光ユニット	
* V4001	WQ842100	FL. DSPLY	18-MT-09GNK		蛍光表示管	
	WA790900	SPACER	4.6/10/32		スペーサ FL	
	WQ920100	P. C. B.	MAIN	JUCTKA	PCB MAIN	
	WQ920200	P. C. B.	MAIN	R	PCB MAIN	
	WQ920300	P. C. B.	MAIN	BGEF	PCB MAIN	
	WQ920400	P. C. B.	MAIN	L	PCB MAIN	
CB152	VQ962900	CN. BS. PIN	8P		ウエハー	01
CB153	VQ963900	CN. BS. PIN	18P		ウエハー	03
CB154	VQ963600	CN. BS. PIN	15P		ウエハー	01

* New Parts * 新規部品

P.C.B. MAIN

Ref No.	Part No.	Description	Remarks	Markets	部 品 名	ランク
CB155	VQ963200	CN. BS. PIN	11P		ウエハー	03
CB158-159	WN077700	CLIP. FUSE	CLIP PFC5000-0202F	R	ヒューズクリップ	
C1001-1003	UR037100	C. EL	10uF 16V		ケミコン	01
C1005-1006	UR037100	C. EL	10uF 16V		ケミコン	01
C1007	WJ605000	C. MYLAR	0.01uF 50V J		マイラーコン	01
C1008	WJ603300	C. MYLAR	470pF 50V J		マイラーコン	01
C1009	UR277220	C. EL	22uF 63V		ケミコン	01
C1011	UR297100	C. EL	10uF 100V		ケミコン	
C1012	WJ603300	C. MYLAR	470pF 50V J		マイラーコン	01
C1014	UR297100	C. EL	10uF 100V		ケミコン	
C1016	UR277220	C. EL	22uF 63V		ケミコン	01
C1017-1018	UR297100	C. EL	10uF 100V		ケミコン	
C1020-1022	WJ603300	C. MYLAR	470pF 50V J		マイラーコン	01
C1023	WJ602900	C. MYLAR	100pF 50V K		マイラーコン	01
C1024	UR067330	C. EL	33uF 50V		ケミコン	01
C1025	WJ602900	C. MYLAR	100pF 50V K		マイラーコン	01
C1026	UR067330	C. EL	33uF 50V		ケミコン	01
C1028	UR067330	C. EL	33uF 50V		ケミコン	01
C1030	WJ602900	C. MYLAR	100pF 50V K		マイラーコン	01
C1031	UR067330	C. EL	33uF 50V		ケミコン	01
C1032	WJ602900	C. MYLAR	100pF 50V K		マイラーコン	01
C1035	UR897100	C. EL	10uF 100V		ケミコン	01
C1036	FG651100	C. CE	10pF 50V		セラコン	01
C1037	WJ602900	C. MYLAR	100pF 50V K		マイラーコン	01
C1038	UR067330	C. EL	33uF 50V		ケミコン	01
C1039	UR866100	C. EL	1uF 50V		ケミコン	01
C1040	FG650500	C. CE	5pF 50V		セラコン	01
C1042	FG650500	C. CE	5pF 50V		セラコン	01
C1044-1045	FG650500	C. CE	5pF 50V		セラコン	01
C1046-1048	WJ605800	C. MYLAR	0.047uF 50V J		マイラーコン	01
C1051-1052	WJ605800	C. MYLAR	0.047uF 50V J		マイラーコン	01
C1053	UR866470	C. EL	4.7uF 50V		ケミコン	01
C1054	UR828220	C. EL	220uF 10V		ケミコン	01
△ C1055	WE514200	C. EL	6800uF 63V	JUCRTKAL	ケミコン	
△ C1055	WN524400	C. EL	6800uF 63V	BGEF	ケミコン	07
△ C1056	WE514200	C. EL	6800uF 63V	JUCRTKAL	ケミコン	
△ C1056	WN524400	C. EL	6800uF 63V	BGEF	ケミコン	07
C1057-1058	WK041800	C. EL	10uF 16V		ケミコン	01
C1059-1060	UR266100	C. EL	1uF 50V		ケミコン	01
C1061	UR858100	C. EL	100uF 35V		ケミコン	01
C1062	UR048470	C. EL	470uF 25V		ケミコン	
C1063-1064	WJ611400	C. MYLAR	0.1uF 100V J		マイラーコン	01
C1065	UR049330	C. EL	3300uF 25V		ケミコン	03
C1066	UR049100	C. EL	1000uF 25V		ケミコン	01
C1067-1068	WN165500	C. PP	0.022uF 100V		PPコン	01
C1069	US135100	C. CE. CHP	0.1uF 16V		チップセラコン	01
C1509	UR067470	C. EL	47uF 50V		ケミコン	01
C1510-1512	US135100	C. CE. CHP	0.1uF 16V		チップセラコン	01
C1513-1514	US061220	C. CE. CHP	22pF 50V B		チップセラコン	01
C1515-1516	US135100	C. CE. CHP	0.1uF 16V		チップセラコン	01
C1517-1520	US062220	C. CE. CHP	220pF 50V B		チップセラコン	01
C1521	UR837100	C. EL	10uF 16V		ケミコン	01
C1522	US061470	C. CE. CHP	47pF 50V B		チップセラコン	01
C1523	UR838100	C. EL	100uF 16V		ケミコン	01
C1524	US061470	C. CE. CHP	47pF 50V B		チップセラコン	01
C1525	UR837100	C. EL	10uF 16V		ケミコン	01
C1526-1527	UR838100	C. EL	100uF 16V		ケミコン	01

* New Parts * 新規部品

RX-V465/HTR-6240/
AX-V465

P.C.B. MAIN

Ref No.	Part No.	Description	Remarks	Markets	部 品 名	ランク
C1528-1529	US062220	C. CE. CHP	220pF 50V B		チップセラコン	01
C1530	UR838100	C. EL	100uF 16V		ケミコン	01
C1531	UR837330	C. EL	33uF 16V		ケミコン	01
C1532-1533	UR838100	C. EL	100uF 16V		ケミコン	01
C1534-1535	US062220	C. CE. CHP	220pF 50V B		チップセラコン	01
C1536	UR838100	C. EL	100uF 16V		ケミコン	01
C1537	WJ605600	C. MYLAR	0.033uF 50V		マイラーコン	
C1538	VR169000	C. MYLAR	0.33uF 50V		マイラーコン	01
C1539	WJ604800	C. MYLAR	8200pF 50V		マイラーコン	
C1540	WJ605600	C. MYLAR	0.033uF 50V		マイラーコン	
C1541	VR169000	C. MYLAR	0.33uF 50V		マイラーコン	01
C1542	US135100	C. CE. CHP	0.1uF 16V		チップセラコン	01
C1543	WJ604800	C. MYLAR	8200pF 50V		マイラーコン	
C1545	US135100	C. CE. CHP	0.1uF 16V		チップセラコン	01
C1553-1554	UR267100	C. EL	10uF 50V		ケミコン	
C1556	UR267100	C. EL	10uF 50V		ケミコン	
C1558-1559	UR267470	C. EL	47uF 50V		ケミコン	01
C1568	VR169200	C. MYLAR	0.47uF 50V		マイラーコン	01
C1572	US062100	C. CE. CHP	100pF 50V B		チップセラコン	01
C1574	UR837100	C. EL	10uF 16V		ケミコン	01
C1575	US061470	C. CE. CHP	47pF 50V B		チップセラコン	01
C1576	UR267100	C. EL	10uF 50V		ケミコン	
C1578	US061470	C. CE. CHP	47pF 50V B		チップセラコン	01
C1579	UR837100	C. EL	10uF 16V		ケミコン	01
C1583-1584	UR267470	C. EL	47uF 50V		ケミコン	01
C1589-1590	UR267100	C. EL	10uF 50V		ケミコン	
C1599	UR267100	C. EL	10uF 50V		ケミコン	
C1602	UR267100	C. EL	10uF 50V		ケミコン	
C1603-1604	US062470	C. CE. CHP	470pF 50V B		チップセラコン	01
C1608	US064100	C. CE. CHP	0.01uF 50V B		チップセラコン	01
C1609	UR049220	C. EL	2200uF 25V		ケミコン	01
D1000-1001	VD631600	DIODE	1SS133, 176		ダイオード	01
D1002	VU171900	DIODE. ZENR	UDZ5.1B 5.1V		ツェナーダイオード	01
D1003	WC398800	DIODE	KDS160-RTK		ダイオード	01
D1004-1005	VN008700	DIODE	1SS270A		ダイオード	01
D1008	WC398800	DIODE	KDS160-RTK		ダイオード	01
D1009-1014	VN008700	DIODE	1SS270A		ダイオード	01
△ D1017	WA653200	DIODE. BRG	TS6P03G 6A 200V		ダイオードブリッジ	04
△ D1018	WH487300	DIODE. BRG	RS203M 2.0A 200V		ダイオードブリッジ	02
D1019	VD631600	DIODE	1SS133, 176		ダイオード	01
D1503-1504	VG438400	DIODE. ZENR	MTZJ6.8C 6.8V		ツェナーダイオード	01
△ F1000	VV071700	FUSE	3.15A 250V	R	ヒューズ	01
△ IC100	X8190A00	IC	STK433-330-E		パワーIC	12
△ IC101	X7427A00	IC	STK433-130-E		アンプIC	04
IC103	XJ608A00	IC	NJM7812FA		IC	02
IC104	X4154A00	IC	KIA7912PI		電源IC	
IC105	YA381A00	IC	LM19CIZ/LF THERMAL		電源IC	
IC152	XZ509A00	IC	TC74VHCU04FT INVER		ロジックIC	01
IC153	YA361A00	IC	R2A15220FP		IC	
IC154	X7378A00	IC	NJM4565M(Te1)		アンプIC	01
PJ150	V5715300	JACK. PIN	2P OR/OR		ピンジャック	02
PJ151	V7046800	JACK. PIN	6P MSP-246V1-01N1		ピンジャック	04
PJ152	V7046700	JACK. PIN	4P MSP-244V1-01N1		ピンジャック	03
PJ159	V7189700	JACK. PIN	1P		ピンジャック	01
PJ160-161	WC612700	JACK. PIN	2P		ピンジャック	01
PN100-102	V9637500	PIN	L=70 #18		スタイルピン	
△ Q1000	WC398400	TR	2N5551C-AT		トランジスタ	01

* New Parts * 新規部品

P.C.B. MAIN and P.C.B. VIDEO

Ref No.	Part No.	Description	Remarks	Markets	部 品 名	ランク
△	Q1001-1002	VC614000 TR	2SB1274 Q, R, S			トランジスタ 02
△	Q1003	WC398400 TR	2N5551C-AT			トランジスタ 01
△	Q1004-1005	WC397700 TR	2N5401C-AT			トランジスタ
△	Q1006-1008	WC398400 TR	2N5551C-AT			トランジスタ 01
△	Q1011-1012	WC398400 TR	2N5551C-AT			トランジスタ 01
△	Q1013	WC397700 TR	2N5401C-AT			トランジスタ
	Q1014	iC181510 TR	2SC1815 Y			トランジスタ 01
	Q1015	WC435000 TR. DGT	KRC102S-RTK			デジタルトランジスタ 01
	Q1016	WC434900 TR. DGT	KRA104S-RTK			デジタルトランジスタ 01
	Q1501-1502	VZ725900 TR	2SD1938F S, T			トランジスタ 01
	Q1504	VZ725900 TR	2SD1938F S, T			トランジスタ 01
	Q1507	VZ725900 TR	2SD1938F S, T			トランジスタ 01
	Q1509	VZ725900 TR	2SD1938F S, T			トランジスタ 01
	Q1520-1521	VZ725900 TR	2SD1938F S, T			トランジスタ 01
	Q1523	VZ725900 TR	2SD1938F S, T			トランジスタ 01
	Q1526	VZ725900 TR	2SD1938F S, T			トランジスタ 01
△	R1012-1013	HV753220 R. CAR. FP	2.2Ω 1/4W			不燃化カーボン抵抗 01
△	R1017	HV755560 R. CAR. FP	560Ω 1/4W			不燃化カーボン抵抗 01
△	R1029	HV754100 R. CAR. FP	10Ω 1/4W			不燃化カーボン抵抗 01
△	R1032	HV754100 R. CAR. FP	10Ω 1/4W			不燃化カーボン抵抗 01
△	R1046	WP839400 R. WW	0.22+0.22 3W			セメント抵抗 01
△	R1048	WP839400 R. WW	0.22+0.22 3W			セメント抵抗 01
△	R1056	WP839400 R. WW	0.22+0.22 3W			セメント抵抗 01
△	R1067-1068	WP839400 R. WW	0.22+0.22 3W			セメント抵抗 01
	R1086	HV754100 R. CAR. FP	10Ω 1/4W			不燃化カーボン抵抗 01
	R1089-1090	HV754100 R. CAR. FP	10Ω 1/4W			不燃化カーボン抵抗 01
	R1098	HV754100 R. CAR. FP	10Ω 1/4W			不燃化カーボン抵抗 01
	R1101	HV754100 R. CAR. FP	10Ω 1/4W			不燃化カーボン抵抗 01
△	R1103	WJ683200 R. MTL. FLM	4.7Ω 1W			金属被膜抵抗
△	R1107-1108	WJ683200 R. MTL. FLM	4.7Ω 1W			金属被膜抵抗
△	R1113-1114	WJ683200 R. MTL. FLM	4.7Ω 1W			金属被膜抵抗
	R1504	HV753100 R. CAR. FP	1Ω 1/4W			不燃化カーボン抵抗 01
	R1664-1665	HV755100 R. CAR. FP	100Ω 1/4W			不燃化カーボン抵抗 01
	R1666-1667	WJ684700 R. MTL. FLM	82Ω 1W			金属被膜抵抗
	RY100	WE648700 RELAY	DC DH24D2-0-Q			リレー 24V 06
	ST100	WA789600 SCR. TERM	M3			スクリューターミナル
	ST101	WA789700 SCR. TERM	D3.5			スクリューターミナル 01
△	SW101	WB493700 VOLT. SELCT	R8140246	R		電圧切替器
△	SW101	WD073700 VOLT. SELCT	R8140254	L		電圧切替器
	U1500-1501	WN333200 CN. PHOTO. R	1P JSR1165			光ファイバー受信器
		WE774200 SCR. BND. HD	3x10 MFZN2W3			バインドBタイトネジ 01
*		WQ922500 P. C. B.	VIDEO	J		PCB VIDEO
*		WQ922600 P. C. B.	VIDEO	UC		PCB VIDEO
*		WQ922800 P. C. B.	VIDEO	R		PCB VIDEO
*		WQ922900 P. C. B.	VIDEO	T		PCB VIDEO
*		WQ923000 P. C. B.	VIDEO	K		PCB VIDEO
*		WQ923100 P. C. B.	VIDEO	A		PCB VIDEO
*		WQ923200 P. C. B.	VIDEO	BGEF		PCB VIDEO
*		WQ923300 P. C. B.	VIDEO	L		PCB VIDEO
	CB301	VQ047700 CN. BS. PIN	22P	J		FFCコネクタ 01
	CB303	VQ961500 CN. BS. PIN	12P			ハウジング 01
	CB321	VM859500 CN. BS. PIN	11P			FFCコネクタ 01
	CB332	VQ961300 CN. BS. PIN	10P			ハウジング 01
	CB333	VK024700 CN. BS. PIN	3P			ワイヤートラップ 01

* New Parts * 新規部品

RX-V465/HTR-6240/AX-V465

P.C.B. VIDEO

Ref No.	Part No.	Description	Remarks	Markets	部 品 名	ランク
CB342	VQ585500	CN. JUMPER	5P		ジャンパーコネクター	02
CB343	VZ130900	CN. JUMPER	4P		ジャンパーコネクター	01
CB344	VQ585700	CN. JUMPER	7P		ジャンパーコネクター	03
CB345	VF728300	CN	6P		コネクター	01
CB349	VQ047700	CN. BS. PIN	22P		F F Cコネクター	01
CB351-353	WD398400	CN. DIN	14P	YKF45-3011	D I Nコネクタ	05
CB354	VQ047700	CN. BS. PIN	22P		F F Cコネクター	01
CB371	VG879900	CN. BS. PIN	2P		ベースピン	01
CB372-373	WN103000	CLIP. FUSE	TP00351-31		ヒューズクリップ	01
CB378	VG879900	CN. BS. PIN	2P		ベースピン	01
CB379	VQ961000	CN. BS. PIN	7P		ハウジング	02
CB381	VQ962800	CN. BS. PIN	7P		ウエハー	02
C3001	US062100	C. CE. CHP	100pF	50V B	チップセラコン	01
C3002-3004	US060800	C. CE. CHP	8pF	50V B	チップセラコン	01
C3005	US062100	C. CE. CHP	100pF	50V B	チップセラコン	01
C3006	UR837470	C. EL	47uF	16V	ケミコン	01
C3007-3008	US135100	C. CE. CHP	0.1uF	16V	チップセラコン	01
C3009	UR837470	C. EL	47uF	16V	ケミコン	01
C3011	US060300	C. CE. CHP	3pF	50V B	チップセラコン	01
C3012	UR837470	C. EL	47uF	16V	ケミコン	01
C3013-3014	US060300	C. CE. CHP	3pF	50V B	チップセラコン	01
C3017	US135100	C. CE. CHP	0.1uF	16V	チップセラコン	01
C3018	UR837100	C. EL	10uF	16V	ケミコン	01
C3019	US135100	C. CE. CHP	0.1uF	16V	チップセラコン	01
C3020	UR837100	C. EL	10uF	16V	ケミコン	01
C3021	US135100	C. CE. CHP	0.1uF	16V	チップセラコン	01
C3024-3025	US135100	C. CE. CHP	0.1uF	16V	チップセラコン	01
C3026	UR837100	C. EL	10uF	16V	ケミコン	01
C3027	WD758300	C. CE. CHP	10uF	10V	チップセラコン	01
C3029	WD758300	C. CE. CHP	10uF	10V	チップセラコン	01
C3031	WD758300	C. CE. CHP	10uF	10V	チップセラコン	01
C3033	UR837470	C. EL	47uF	16V	ケミコン	01
C3043-3044	US135100	C. CE. CHP	0.1uF	16V	チップセラコン	01
C3045	UR837470	C. EL	47uF	16V	ケミコン	01
C3047	US135100	C. CE. CHP	0.1uF	16V	チップセラコン	01
C3048	UR838220	C. EL	220uF	16V	ケミコン	01
C3050	US135100	C. CE. CHP	0.1uF	16V	チップセラコン	01
C3051	UR838220	C. EL	220uF	16V	ケミコン	01
C3063	US135100	C. CE. CHP	0.1uF	16V	チップセラコン	01
C3065	UR837470	C. EL	47uF	16V	ケミコン	01
C3067	US135100	C. CE. CHP	0.1uF	16V	チップセラコン	01
C3072	US135100	C. CE. CHP	0.1uF	16V	チップセラコン	01
C3073	UR838220	C. EL	220uF	16V	ケミコン	01
C3077	US135100	C. CE. CHP	0.1uF	16V	チップセラコン	01
C3080-3085	WD758300	C. CE. CHP	10uF	10V	チップセラコン	01
C3201	US061270	C. CE. CHP	27pF	50V B	チップセラコン	01
C3201	US061270	C. CE. CHP	27pF	50V B	チップセラコン	01
C3202	UR837100	C. EL	10uF	16V	ケミコン	01
C3202	UR837100	C. EL	10uF	16V	ケミコン	01
C3203	US061270	C. CE. CHP	27pF	50V B	チップセラコン	01
C3203	US061270	C. CE. CHP	27pF	50V B	チップセラコン	01
C3204	US135100	C. CE. CHP	0.1uF	16V	チップセラコン	01
C3204	US135100	C. CE. CHP	0.1uF	16V	チップセラコン	01
C3205	US135100	C. CE. CHP	0.1uF	16V	チップセラコン	01
C3205	US135100	C. CE. CHP	0.1uF	16V	チップセラコン	01
C3206	US062560	C. CE. CHP	560pF	50V B	チップセラコン	01
C3206	US062560	C. CE. CHP	560pF	50V B	チップセラコン	01

* New Parts * 新規部品

P.C.B. VIDEO

Ref No.	Part No.	Description	Remarks	Markets	部 品 名	ランク	
C3207	US062330	C. CE. CHP	330pF 50V B		BGEF	チップセラコン	01
C3207-3208	US062330	C. CE. CHP	330pF 50V B			チップセラコン	01
C3208	US062330	C. CE. CHP	330pF 50V B		BGEF	チップセラコン	01
C3209	US135100	C. CE. CHP	0. 1uF 16V			チップセラコン	01
C3209	US135100	C. CE. CHP	0. 1uF 16V		BGEF	チップセラコン	01
C3211	UR837470	C. EL	47uF 16V			ケミコン	01
C3211	UR837470	C. EL	47uF 16V		BGEF	ケミコン	01
C3212-3214	UR837470	C. EL	47uF 16V			ケミコン	01
C3215	US062100	C. CE. CHP	100pF 50V B			チップセラコン	01
C3218	US062100	C. CE. CHP	100pF 50V B			チップセラコン	01
C3303-3305	WJ611400	C. MYLAR	0. 1uF 100V J			マイラーコン	01
C3306	UR868100	C. EL	100uF 50V			ケミコン	01
C3307	WG601900	C. EL	10000uF 16V			ケミコン	04
C3309	WG601900	C. EL	10000uF 16V			ケミコン	04
C3310	UR039470	C. EL	4700uF 16V			ケミコン	03
C3311	UR866100	C. EL	1uF 50V			ケミコン	01
C3312	UR837220	C. EL	22uF 16V			ケミコン	01
C3314	UR866100	C. EL	1uF 50V			ケミコン	01
C3319	UR866100	C. EL	1uF 50V			ケミコン	01
C3320-3321	UR837330	C. EL	33uF 16V			ケミコン	01
C3322	UR867100	C. EL	10uF 50V			ケミコン	01
C3323	UR878100	C. EL	100uF 63V			ケミコン	01
C3403	WJ605000	C. MYLAR	0. 01uF 50V J			マイラーコン	01
C3405-3407	WJ605000	C. MYLAR	0. 01uF 50V J			マイラーコン	01
C3409	WJ605000	C. MYLAR	0. 01uF 50V J			マイラーコン	01
C3410-3411	WJ604500	C. MYLAR	4700pF 50V			マイラーコン	
C3412-3414	WJ605200	C. MYLAR	0. 015uF 50V			マイラーコン	
C3501-3509	US064100	C. CE. CHP	0. 01uF 50V B		J	チップセラコン	01
C3510-3512	US060800	C. CE. CHP	8pF 50V B		J	チップセラコン	01
C3513-3514	UR837100	C. EL	10uF 16V		J	ケミコン	01
C3515-3520	US135100	C. CE. CHP	0. 1uF 16V		J	チップセラコン	01
C3701	WQ852400	C. POL. MTL	0. 022uF 630V			メタライズドポリコン	
△ C3702	WK005000	C. CE. SAFTY	0. 047uF 275V			規格認定コンデンサ	01
* C3703	WR082000	C. EL	100uF 220V		JUC	ケミコン	
* C3703	WR082100	C. EL	100uF 400V		R	ケミコン	
* C3703	WQ852500	C. EL	68uF 400V		TKABGEFL	ケミコン	
* C3704	WR182800	C. CE. CHP	2200pF 250V			チップセラコン	
C3705	US065100	C. CE. CHP	0. 1uF 50V B			チップセラコン	01
△ * C3706	WQ939400	C. CE. SAFTY	0. 01uF 250V			規格認定コンデンサ	
C3707	UR837470	C. EL	47uF 16V			ケミコン	01
C3708	UR867100	C. EL	10uF 50V			ケミコン	01
△ * C3709	WQ902200	C. CE. SAFTY	2200pF 250V			規格認定コン	
C3710-3711	UR866100	C. EL	1uF 50V			ケミコン	01
C3712-3713	WH777900	C. EL	1000uF 35V			ケミコン	
C3714	US046100	C. CE. CHP	1uF 25V			チップセラコン	01
C3715	US135100	C. CE. CHP	0. 1uF 16V			チップセラコン	01
C3716	WH771300	C. EL	100uF 10V			ケミコン	01
* C3717	WQ852400	C. POL. MTL	0. 022uF 630V			メタライズドポリコン	
△ * C3720-3721	WQ902300	C. CE. SAFTY	1000pF 250V			規格認定コンデンサ	
C3801	US064100	C. CE. CHP	0. 01uF 50V B			チップセラコン	01
C3802	V7887800	C. EL	1uF 50V			ケミコン	
C3803	WJ335500	C. EL	2. 2uF 50V			ケミコン	01
C3804	WJ603700	C. MYLAR	1000pF 50V			マイラーコン	01
C3805	US064100	C. CE. CHP	0. 01uF 50V B			チップセラコン	01
C3806-3807	WD758300	C. CE. CHP	10uF 10V			チップセラコン	01
D3201	VG436100	DIODE. ZENR	MTZJ3. 3B 3. 3V			ツェナーダイオード	01
D3201	VG436100	DIODE. ZENR	MTZJ3. 3B 3. 3V		BGEF	ツェナーダイオード	01

* New Parts * 新規部品

P.C.B. VIDEO

Ref No.	Part No.	Description	Remarks	Markets	部 品 名	ランク
△	D3202	VG439500 DIODE. ZENR	MTZJ10B 10V		ツェナーダイオード	01
△	D3302	WH487300 DIODE. BRG	RS203M 2.0A 200V		ダイオードブリッジ	02
△	D3304	WH487300 DIODE. BRG	RS203M 2.0A 200V		ダイオードブリッジ	02
	D3305	VG444700 DIODE. ZENR	MTZ J 39D 39.0V TP		ツェナーダイオード	01
	D3307	VG440800 DIODE. ZENR	MTZJ15B 15V		ツェナーダイオード	01
	D3310	VT332900 DIODE	1SS355		ダイオード	01
	D3312	VV307700 DIODE	1N4002S		ダイオード	01
	D3320	VG437400 DIODE. ZENR	MTZJ5.1B 5.1V		ツェナーダイオード	01
	D3403-3404	VT332900 DIODE	1SS355		ダイオード	01
	D3406-3407	VT332900 DIODE	1SS355		ダイオード	01
	D3501-3506	VT332900 DIODE	1SS355	J	ダイオード	01
△	D3701	WH471700 DIODE. BRG	DB105 1A 600V		ダイオードブリッジ	02
	D3703	WN672400 DIODE. ZENR	P6KE200A 200V		ツェナーダイオード	03
	D3705	WQ647500 DIODE	HT18G		ダイオード	
	D3706-3707	VD631600 DIODE	1SS133, 176		ダイオード	01
	D3708	VT332900 DIODE	1SS355		ダイオード	01
	D3709	WR007000 DIODE. SCHO	10A 40V SG10SC4M		ショットキーダイオード	
	D3710	VG442200 DIODE. ZENR	MTZJ22C 22V		ツェナーダイオード	01
	D3801-3805	VT332900 DIODE	1SS355		ダイオード	01
	F3701	WB221200 FUSE	T6A 125V	JUC	ヒューズ	01
	F3701	WB760600 FUSE	T6.3A 250V	R	ヒューズ	01
	F3701	VV071700 FUSE	3.15A 250V	TKABGEFL	ヒューズ	01
	IC303	XY879A00 IC	TC74HC4053AF (EL)		ロジック IC	03
	IC305	X6742A00 IC	LA73050-TLM-E		アンプ IC	04
	IC306	X2904A00 IC	NJM2581M VIDEO AMP		アンプ IC	06
	IC307	XY549A00 IC	TC74HC4051AFEL		ロジック IC	02
	IC308	X7779A00 IC	LC709004A-TLM-E		ロジック IC	04
	IC310	X8875A00 IC	FHP33501M14X		アンプ IC	04
*	IC321	X8235A00 IC	LC72725KM		IC	
*	IC321	X8235A00 IC	LC72725KM	BGEF	IC	
	IC331	X8276A00 IC	NJM2396F05		電源 IC	04
	IC334	X6143A00 IC	NJM2388F05 5.0V		電源 IC	04
	IC351-352	XS790A00 IC	TC74HC4052AF MPX	J	ロジック IC	02
	IC353	XY879A00 IC	TC74HC4053AF (EL)	J	ロジック IC	03
	IC371	YA565A00 IC	TOP254PN SW		電源 IC	
△ *	IC372	WQ867100 PHOT. CPL	EL816(M) (C)		フォトカプラ	
*	IC374	YA276A00 IC	TL431AC 2.5-36V		電源 IC	
△ *	IC375	WQ867100 PHOT. CPL	EL816(M) (C)		フォトカプラ	
	PJ301	WG505100 JACK. PIN	6P		ピンジャック	04
	PJ302	V7189800 JACK. PIN	1P		ピンジャック	01
	PJ303	WH381400 JACK. PIN	3P JACK G, B, R		ピンジャック	03
	PJ304	V7189800 JACK. PIN	1P		ピンジャック	01
	PJ305-306	V7190000 JACK. PIN	2P		ピンジャック	
	PN341-343	V9637500 PIN	L=70 #18		スタイルピン	
	PN381	V9637500 PIN	L=70 #18		スタイルピン	
	Q3001	VR936300 TR	2SA1576A T106		トランジスタ	01
	Q3201	iC174020 TR	2SC1740S QRS		トランジスタ	01
	Q3201	iC174020 TR	2SC1740S QRS	BGEF	トランジスタ	01
	Q3203	WJ173600 TR	2SC1815Y TP		トランジスタ	01
	Q3302	WJ173500 TR	2SA1015Y Y TP		トランジスタ	
	Q3303	WG538600 TR	KTA1046-Y-U/P		トランジスタ	02
	Q3304	WJ173500 TR	2SA1015Y Y TP		トランジスタ	
	Q3305	WJ173600 TR	2SC1815Y TP		トランジスタ	01
△	Q3306	WC397700 TR	2N5401C-AT		トランジスタ	
	Q3405	VV655400 TR. DGT	DTC114EKA		デジタルトランジスタ	01
	Q3406	VV655000 TR. DGT	DTA114EKA		デジタルトランジスタ	01
	Q3407	VV655400 TR. DGT	DTC114EKA		デジタルトランジスタ	01

* New Parts * 新規部品

P.C.B. VIDEO

Ref No.	Part No.	Description	Remarks	Markets	部 品 名	ランク
Q3408	VV655000	TR. DGT	DTA114EKA		デジタルトランジスタ	01
Q3411	VV655400	TR. DGT	DTC114EKA		デジタルトランジスタ	01
Q3412	VV655000	TR. DGT	DTA114EKA		デジタルトランジスタ	01
Q3413	VV655400	TR. DGT	DTC114EKA		デジタルトランジスタ	01
Q3414	VV655000	TR. DGT	DTA114EKA		デジタルトランジスタ	01
Q3501	VV556400	TR	2SC2412K Q, R, S	J	トランジスタ	01
Q3801-3802	WJ173600	TR	2SC1815Y TP		トランジスタ	01
Q3803	VV655700	TR. DGT	DTC144EKA		デジタルトランジスタ	01
R3021	HV753100	R. CAR. FP	1Ω 1/4W		不燃化カーボン抵抗	01
R3025	HV753100	R. CAR. FP	1Ω 1/4W		不燃化カーボン抵抗	01
R3046-3049	HV753100	R. CAR. FP	1Ω 1/4W		不燃化カーボン抵抗	01
R3060-3061	HV753100	R. CAR. FP	1Ω 1/4W		不燃化カーボン抵抗	01
R3208	HV755680	R. CAR. FP	680Ω 1/4W		不燃化カーボン抵抗	01
R3208	HV755680	R. CAR. FP	680Ω 1/4W	BGEF	不燃化カーボン抵抗	01
R3210	HV754180	R. CAR. FP	18Ω 1/4W		不燃化カーボン抵抗	01
R3315-3316	HV756470	R. CAR. FP	4.7KΩ 1/4W		不燃化カーボン抵抗	01
R3325	HV756220	R. CAR. FP	2.2KΩ 1/4W		不燃化カーボン抵抗	01
△ R3326	HV753220	R. CAR. FP	2.2Ω 1/4W		不燃化カーボン抵抗	01
R3330	HV753100	R. CAR. FP	1Ω 1/4W		不燃化カーボン抵抗	01
R3405-3406	HV757100	R. CAR. FP	10KΩ 1/4W		不燃化カーボン抵抗	01
R3524-3525	HV753100	R. CAR. FP	1Ω 1/4W	J	不燃化カーボン抵抗	01
RY341-342	WJ122400	RELAY	981-2A-24DS-SP7		リレー 24V	04
RY344-345	WJ122400	RELAY	981-2A-24DS-SP7		リレー 24V	04
△ * RY371	WQ804100	RELAY	DC DLS5D1-0(M) 0.25		リレー	
ST331-332	WA789700	SCR. TERM	D3.5		スクリューターミナル	01
ST371	WA789700	SCR. TERM	D3.5		スクリューターミナル	01
ST381-383	WA789700	SCR. TERM	D3.5		スクリューターミナル	01
△ T3701	YA507A00	TRANS. PWR			サブトランス	
TE341	WK560800	TERM. SP	4P MST-204V1-01 NC	JUCRTA	スピーカーターミナル	04
TE341	WK560900	TERM. SP	4P MST-204V1-01 WC	KBGEFL	スピーカーターミナル	
TE341	WK560900	TERM. SP	4P MST-204V1-01 WC		スピーカーターミナル	
TE342	WB214000	TERM. SP	6P PUSH MSP-115V2		スピーカーターミナル	03
XL321	V2731100	RSNR. CRYST	4.332M HC-49/U		水晶振動子	
XL321	V2731100	RSNR. CRYST	4.332M HC-49/U	BGEF	水晶振動子	
	WE774200	SCR. BND. HD	3x10 MFZN2W3		バインドBタイトネジ	01

* New Parts * 新規部品

Carbon Resistors

Value	1/4W Type Part No.	1/6W Type Part No.	Value	1/4W Type Part No.	1/6W Type Part No.
1.0 Ω	HJ35 3100	HF85 3100	11 kΩ	HF45 7110	HF45 7110
1.8 Ω	HJ35 3180	*	12 kΩ	HJ35 7120	HF85 7120
2.2 Ω	HJ35 3220	HF85 3220	13 kΩ	HF45 7130	HF45 7130
3.3 Ω	HJ35 3330	HF85 3330	15 kΩ	HF45 7150	HF45 7150
4.7 Ω	HJ35 3470	HF85 3470	18 kΩ	HF45 7180	HF45 7180
5.6 Ω	HJ35 3560	HF85 3560	22 kΩ	HF45 7220	HF45 7220
10 Ω	HF45 4100	HF45 4100	24 kΩ	HF45 7240	HF45 7240
15 Ω	HJ35 4150	HF45 4150	27 kΩ	HJ35 7270	HF85 7270
22 Ω	HF45 4220	HF45 4220	30 kΩ	HF45 7300	HF45 7300
27 Ω	HJ35 4270	HF85 4270	33 kΩ	HF45 7330	HF45 7330
33 Ω	HF45 4330	HF45 4330	36 kΩ	HF45 7360	HF45 7360
39 Ω	HJ35 4470	HF85 4390	39 kΩ	HF45 7390	HF45 7390
47 Ω	HF45 4470	HF45 4470	47 kΩ	HF45 7470	HF45 7470
56 Ω	HF45 4560	HF45 4560	51 kΩ	HF45 7510	HF45 7510
68 Ω	HF45 4680	HF45 4680	56 kΩ	HF45 7560	HF45 7560
75 Ω	HF45 4750	HF45 4750	62 kΩ	HF45 7620	HF45 7620
82 Ω	HF45 4820	HF45 4820	68 kΩ	HF45 7680	HF45 7680
91 Ω	HF45 4910	HF45 4910	82 kΩ	HF45 7820	HF45 7820
100 Ω	HF45 5100	HF45 5100	91 kΩ	HF45 7910	HF45 7910
110 Ω	HJ35 5110	HF85 5110	100 kΩ	HF45 8100	HF45 8100
120 Ω	HF45 5120	HF45 5120	110 kΩ	HF45 8110	HF45 8110
150 Ω	HF45 5150	HF45 5150	120 kΩ	HF45 8120	HF45 8120
160 Ω	HJ35 5160	*	150 kΩ	HF45 8150	HF45 8150
180 Ω	HF45 5180	HF45 5180	180 kΩ	HF45 8180	HF45 8180
200 Ω	HF45 5200	HF45 5200	220 kΩ	HJ35 8220	HF85 8220
220 Ω	HF45 5220	HF45 5220	270 kΩ	HF45 8270	HF45 8270
270 Ω	HF45 5270	HF45 5270	300 kΩ	HF45 8300	HF45 8300
330 Ω	HF45 5330	HF45 5330	330 kΩ	HF45 8330	HF45 8330
390 Ω	HF45 5390	HF45 5390	390 kΩ	HJ35 8390	HF85 8390
430 Ω	HF45 5430	HF45 5430	470 kΩ	HF45 8470	HF45 8470
470 Ω	HF45 5470	HF45 5470	560 kΩ	HJ35 8560	HF85 8560
510 Ω	HF45 5510	HF45 5510	680 kΩ	HJ35 8680	HF85 8680
560 Ω	HF45 5560	HF45 5560	820 kΩ	HJ35 8820	HF85 8820
680 Ω	HF45 5680	HF45 5680	1.0 MΩ	HF45 9100	HF45 9100
820 Ω	HF45 5820	HF45 5820	1.2 MΩ	HJ35 9120	*
910 Ω	HF45 5910	HF45 5910	1.5 MΩ	HJ35 9150	HF85 9150
1.0 kΩ	HF45 6100	HF45 6100	1.8 MΩ	HJ35 9180	HF85 9180
1.2 kΩ	HF45 6120	HF45 6120	2.2 MΩ	HJ35 9220	HF85 9220
1.5 kΩ	HF45 6150	HF45 6150	3.3 MΩ	HJ35 9330	HF85 9330
1.8 kΩ	HF45 6180	HF45 6180	3.9 MΩ	HJ35 9390	*
2.0 kΩ	HJ35 6200	HF85 6200	4.7 MΩ	HJ35 9470	HF85 9470
2.2 kΩ	HF45 6220	HF45 6220			
2.4 kΩ	HJ35 6240	HF85 6240			
2.7 kΩ	HF45 6270	HF45 6270			
3.0 kΩ	HF45 6300	HF45 6300			
3.3 kΩ	HF45 6330	HF45 6330			
3.6 kΩ	HJ35 6360	HF85 6360			
3.9 kΩ	HF45 6390	HF45 6390			
4.7 kΩ	HF45 6470	HF45 6470			
5.1 kΩ	HF45 6510	HF45 6510			
5.6 kΩ	HF45 6560	HF45 6560			
6.8 kΩ	HF45 6680	HF45 6680			
8.2 kΩ	HF45 6820	HF45 6820			
9.1 kΩ	HF45 6910	HF45 6910			
10 kΩ	HF45 7100	HF45 7100			

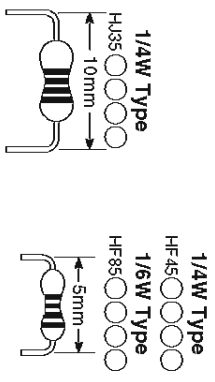

* : Not available

• OVERALL ASS'Y

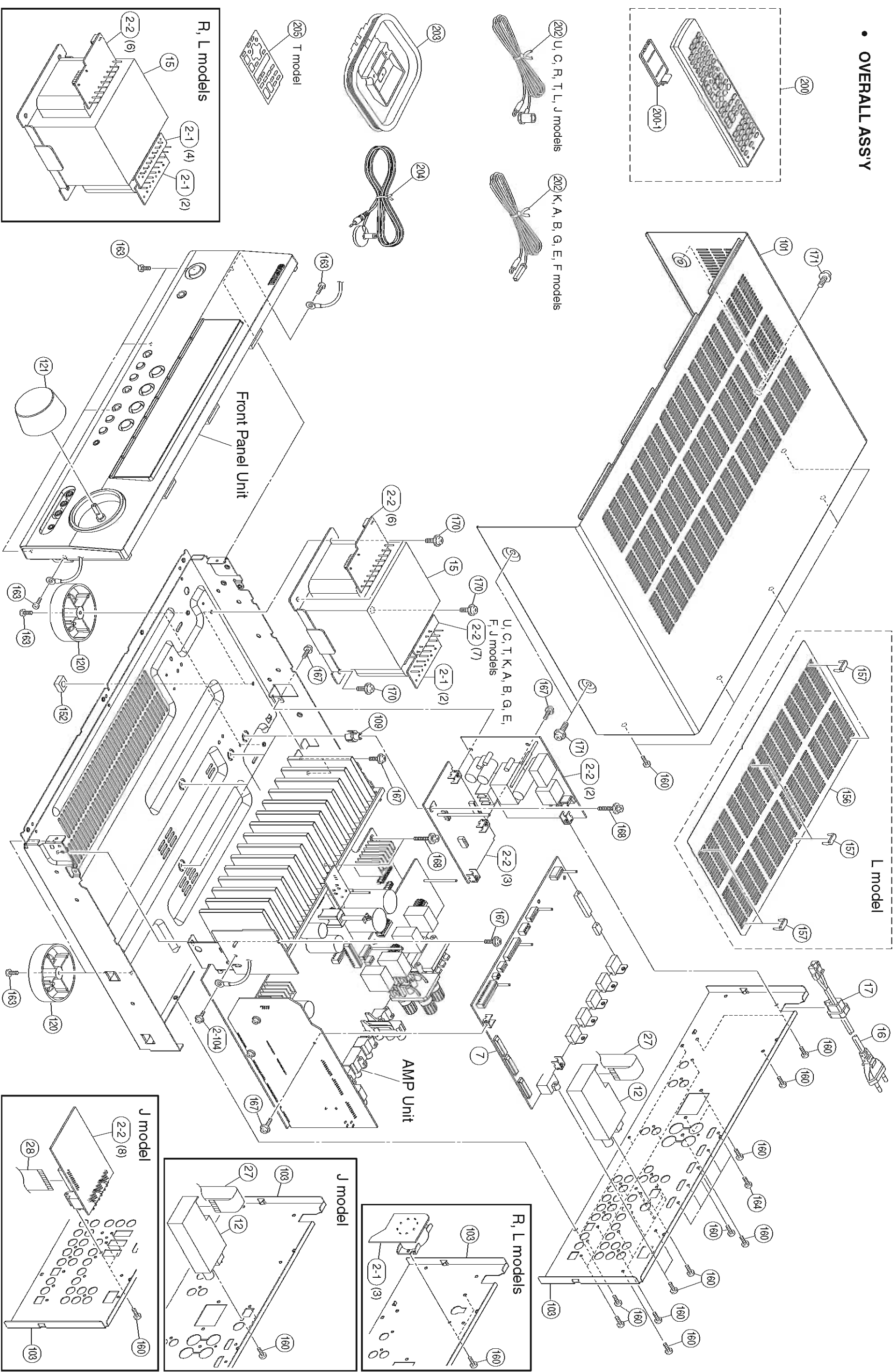

Ref No.	Part No.	Description	Remarks	Markets	部 品 名	ラック
* 2-1	W0920100	P.C.B. ASS'Y		JUCTKA	PCB MAIN	01
* 2-1	W0920200	P.C.B. ASS'Y		R	PCB MAIN	
* 2-1	W0920300	P.C.B. ASS'Y		BGEF	PCB MAIN	
* 2-1	W0920400	P.C.B. ASS'Y		L	PCB MAIN	
* 2-2	W0922500	P.C.B. ASS'Y		J	PCB VIDEO	
* 2-2	W0922600	P.C.B. ASS'Y		UC	PCB VIDEO	
* 2-2	W0922800	P.C.B. ASS'Y		R	PCB VIDEO	
* 2-2	W0922900	P.C.B. ASS'Y		T	PCB VIDEO	
* 2-2	W0923000	P.C.B. ASS'Y		K	PCB VIDEO	
* 2-2	W0923100	P.C.B. ASS'Y		A	PCB VIDEO	
* 2-2	W0923200	P.C.B. ASS'Y		BGEF	PCB VIDEO	
* 2-2	W0923300	P.C.B. ASS'Y		L	PCB VIDEO	
* 2-104	WF002600	PM HEAD B-TIGHT SCREW			PMヘッドBタイプネジ	01
* 7	W0925600	P.C.B. ASS'Y		JUCTKA	PCB DIGITAL	
* 7	W0925800	P.C.B. ASS'Y		UCFK	PCB DIGITAL	
* 7	W0925700	P.C.B. ASS'Y		BGEF	PCB DIGITAL	
* 7	W0925900	P.C.B. ASS'Y		EF	PCB DIGITAL	
* 12	W0756500	AM/FM TUNER		J	AM/FMチューナー	
* 12	W0756600	AM/FM TUNER		UORTL	AM/FMチューナー	
* 12	W0756700	AM/FM TUNER		KABGEF	AM/FMチューナー	
* 15	YA527A00	POWER TRANSFORMER		UC	電源トランス	
* 15	YA528A00	POWER TRANSFORMER		RL	電源トランス	
* 15	YA529A00	POWER TRANSFORMER		TK	電源トランス	
* 15	YA531A00	POWER TRANSFORMER		A	電源トランス	
* 15	YA530A00	POWER TRANSFORMER		BGEF	電源トランス	
* 15	YA532A00	POWER TRANSFORMER		J	電源コード	07
* 16	WB21800	POWER CABLE		UC	電源コード	
* 16	WB120500	POWER CABLE		R	電源コード	
* 16	WB392700	POWER CABLE		T	電源コード	
* 16	WB120600	POWER CABLE		K	電源コード	
* 16	WC753000	POWER CABLE		A	電源コード	
* 16	WC743700	POWER CABLE		B	電源コード	
* 16	WB212300	POWER CABLE		GEFL	電源コード	
* 16	VB438700	CORD STOPPER			コードストッパー	02
* 27	WR385200	FLEXIBLE FLAT CABLE		J	カード電線	
* 27	WR384700	FLEXIBLE FLAT CABLE		UORTKABGEFL	カード電線	
* 28	WR396800	FLEXIBLE FLAT CABLE		J	カード電線	
* 101	W0665900	TOP COVER		GD	トップカバー	
* 101	W0665800	TOP COVER		BL	トップカバー	
* 101	W0666000	TOP COVER		TI	トップカバー	
* 101	W0666100	TOP COVER		SI	トップカバー	
* 103	W0683000	REAR PANEL		J	リアパネル	
* 103	W0682100	REAR PANEL		U	リアパネル	
* 103	W0683100	REAR PANEL		U	リアパネル	
* 103	W0682200	REAR PANEL		C	リアパネル	
* 103	W0683200	REAR PANEL		C	リアパネル	
* 103	W0682300	REAR PANEL		R	リアパネル	
* 103	W0682400	REAR PANEL		T	リアパネル	
* 103	W0683300	REAR PANEL		T	リアパネル	
* 103	W0682500	REAR PANEL		K	リアパネル	
* 103	W0683400	REAR PANEL		K	リアパネル	
* 103	W0682600	REAR PANEL		A	リアパネル	

* New Parts * 新規部品

Ref No.	Part No.	Description	Remarks	Markets	部 品 名	ラック
* 103	W0682700	REAR PANEL		V465	リアパネル	
* 103	W0683600	REAR PANEL		6240	リアパネル	
* 103	W0682900	REAR PANEL		L	リアパネル	
* 109	WH242000	SUPPORT H8			サポート H8	01
* 120	WA790600	LEG		GD	レッグ	
* 120	WA790500	LEG		BL, TI, SI	レッグ	
* 121	W0822800	KN08 D50		GD	ノブ D50	
* 121	W0822700	KN08 D50		BL	ノブ D50	
* 121	W0823000	KN08 D50		TI	ノブ D50	
* 121	W0822900	KN08 D50		SI	ノブ D50	
* 152	WP126800	DAMPER			ダンパー	
* 156	WR306100	SHEET TOP			シート トップ	
* 157	WJ323900	RIVET TOP		L	リベット トップ	
* 160	WE74100	BLIND HEAD BONDING B-T. SCREW			ボンディングBタイプネジ	01
* 163	WE74300	BLIND HEAD B-TIGHT SCREW			バインドBタイプネジ	01
* 164	WE877900	BLIND HEAD S-TIGHT SCREW			バインドSタイプネジ	01
* 167	WF002600	PM HEAD B-TIGHT SCREW			PWヘッドBタイプネジ	01
* 168	WE74600	SCREW 1G			スクリュー 1G	01
* 170	WE74700	BLIND HEAD S-TIGHT SCREW			バインドSタイプネジ	01
* 171	V0069600	PM HEAD S-TIGHT SCREW		GD, TI, SI	PWヘッドSタイプネジ	01
* 171	YH313200	PM HEAD S-TIGHT SCREW		BL	PWヘッドSタイプネジ	01
* 200	WR002700	ACCESSORIES			付属品	
* 200-1	AAK82380	REMOTE CONTROL		RAV293	リモコン	03
* 202	WR212500	INDOOR FM ANTENNA		09-2209	電池蓋	03
* 202	WR212400	INDOOR FM ANTENNA			F.M簡易アンテナ	04
* 203	WR212600	AM LOOP ANTENNA			AMループアンテナ	08
* 204	WN649600	OPTIMIZER MICROPHONE		EM6022L-HN1700	オプティマイザーマイク	
* 205	WR475900	SHEET ROU		T	シートRCU	
		BATTERY			単4乾電池	
		SERVICE TOOLS			サービス用部品	
	WR492800	RS232C CONVERSION ADAPTOR			RS232C変換アダプター	13
	MF109400	FLEXIBLE FLAT CABLE			カード電線	
	MF125400	FLEXIBLE FLAT CABLE			カード電線	

* New Parts * 新規部品

KEY NO. LAYOUT

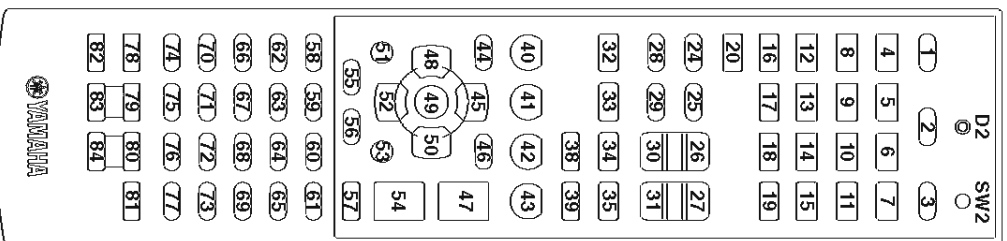

KEY CODE

GROUP	PRE SET	Key No.	FUNCTION	COM	ID1	ID2
					MAIN	MAIN
	-	LED1	TRANSMIT	-	-	-
	-	SW2	CODE SET	-	-	-
POWER	-	K2	SLEEP	0	7A-30	7A-30CE
	-	K3	POWER	0	7E-2A	7E-2AD4
	0	K4	HDMI-1	0	7A-4738	7A-4739
	0	K5	HDMI-2	0	7A-4A35	7A-4A34
0	K6	HDMI-3	0	7A-4D32	7A-4D33	
0	K7	HDMI-4	0	7A-502F	7A-502E	
0	K8	AV-1	0	7A-532C	7A-532D	
0	K9	AV-2	0	7A-5629	7A-5628	
0	K10	AV-3	0	7A-5926	7A-5927	
0	K11	AV-4	0	7A-5C23	7A-5C22	
0	K12	AV-5	0	7A-5F20	7A-5F21	
0	K13	AV-6	0	7A-621D	7A-621C	
0	K14	AUDIO-1	0	7A-651A	7A-651B	
0	K15	AUDIO-2	0	7A-6817	7A-6816	
0	K16	V-AUX	0	7A-55	7A-55AB	
0	K17	[A]	0	-	-	
INPUT 2	-	K18	[B]	0	7F01-3F	7F01-3FC1
	-	K19	DOCK	0	7F01-4A	7F01-4AB4
	-	K20	TUNER	0	7A-16	7A-16E8
RADIO	-	K24	CATEGORY (-) FM	0	7F01-5827	7F01-5826
	-	K25	CATEGORY (+) AM	0	7F01-552A	7F01-552B
	-	K26	PRESET (+)	0	7F01-5B24	7F01-5B25
	-	K27	TUNING/CH (+)	0	7F01-611E	7F01-611F
	-	K28	INFO	0	7A-2758	7A-2759
	-	K29	MEMORY	0	7F01-6718	7F01-6719
	-	K30	PRESET (-)	0	7F01-5E21	7F01-5E20
	-	K31	TUNING/CH (-)	0	7F01-6A1B	7F01-6A1A
	-	K32	MOVIE	0	7A-88	7A-8876
	-	K33	MUSIC	0	7A-89	7A-8977
	-	K34	STEREO/ENHANCER	0	7A-94	7A-946A
	-	K35	SUR. DECODE	0	7A-8D	7A-8D73
	-	K36	(no key)	0	7A-59	7A-59A7
	-	K37	(no key)	0	7A-58	7A-58A6
SCENE	-	K38	STRAIGHT	0	7A-56	7A-56A8
	-	K39	PURE DIRECT	0	7A-DD	7A-DD23
	-	K40	BD/DVD	0	7A-007F	7A-007E
	-	K41	TV	0	7A-037C	7A-037D
	-	K42	CD	0	7A-0679	7A-0678
	-	K43	RADIO or GAME	0	7A-0976	7A-0977
MENU	-	K44	SETUP	0	7A-84	7A-847A
	-	K46	SUBMENU	0	7A-6B14	7A-6B15

GROUP	PRE SET	Key No.	FUNCTION	COM	ID1	ID2
					MAIN	MAIN
CURSOR	-	K45	UP	-	7A-9D	7A-9D63
	-	K48	LEFT	-	7A-9F	7A-9F61
	-	K49	ENTER	-	7A-DE	7A-DE20
	-	K50	RIGHT	-	7A-9E	7A-9E60
	-	K51	RETURN	-	7A-AA	7A-AA54
	-	K52	DOWN	-	7A-9C	7A-9C62
VOLUME	-	K53	(DISPLAY)	-	7F01-609E	7F01-609E
	-	K47	VOLUME (+)	0	7A-1A	7A-1AE4
	-	K54	VOLUME (-)	0	7A-1B	7A-1BE5
	-	K57	MUTE	0	7A-1C	7A-1CE2
	-	K1	POWER (SOURCE)	-	-	-
SOURCE	-	K55	TOP MENU	-	-	-
	-	K56	MENU	-	-	-
	-	K58	REC	-	-	-
	-	K59	PLAY	-	-	-
	-	K60	STOP	-	-	-
	-	K61	PAUSE	-	-	-
	-	K62	REW	-	-	-
	-	K63	FF	-	-	-
10 Key	-	K64	SKIP (-)	-	-	-
	-	K65	SKIP (+)	-	-	-
	-	K66	1	-	-	-
	-	K67	2	-	-	-
	-	K68	3	-	-	-
	-	K69	4	-	-	-
	-	K70	5	-	-	-
	-	K71	6	-	-	-
	-	K72	7	-	-	-
	-	K73	8	-	-	-
TV	-	K74	9	-	-	-
	-	K75	0	-	-	-
	-	K76	+10	-	-	-
	-	K77	ENT	-	-	-
	-	K78	TV INPUT	-	-	-
	-	K79	TV VOL (+)	-	-	-
	-	K80	TV CH (+)	-	-	-
	-	K81	TV POWER	-	-	-
	-	K82	TV MUTE	-	-	-
	-	K83	TV VOL (-)	-	-	-
-	K84	TV CH (-)	-	-	-	
-	K85	(no key)	-	-	-	

* Function code

* Function code

* TV mode

FUNCTION CODE

Key No.	Brand	Function	BD		DVD		DVR		LD		CD		CD-R		MD	
			Yamaha-1	Yamaha-2	Yamaha-1	Yamaha-2	Yamaha-1	Yamaha-2	Yamaha-1	Yamaha-2	Yamaha-1	Yamaha-2	Yamaha-1	Yamaha-2	Yamaha-1	Yamaha-2
K45	Yamaha-1	UP	7C-94	7C-94	2002	2002	2002	2002	2002	2002	2002	2002	2002	2002	2002	2002
K46	Yamaha-1	DOWN	7C-95	7C-95	2002	2002	2002	2002	2002	2002	2002	2002	2002	2002	2002	2002
K47	Yamaha-1	LEFT	7C-96	7C-96	2002	2002	2002	2002	2002	2002	2002	2002	2002	2002	2002	2002
K48	Yamaha-1	RIGHT	7C-97	7C-97	2002	2002	2002	2002	2002	2002	2002	2002	2002	2002	2002	2002
K49	Yamaha-1	ENTER	7C-98	7C-98	2002	2002	2002	2002	2002	2002	2002	2002	2002	2002	2002	2002
K50	Yamaha-1	RETURN	7C-99	7C-99	2002	2002	2002	2002	2002	2002	2002	2002	2002	2002	2002	2002
K51	Yamaha-1	STOP	7C-9A	7C-9A	2002	2002	2002	2002	2002	2002	2002	2002	2002	2002	2002	2002
K52	Yamaha-1	PAUSE	7C-9B	7C-9B	2002	2002	2002	2002	2002	2002	2002	2002	2002	2002	2002	2002
K53	Yamaha-1	SKIP (+)	7C-9C	7C-9C	2002	2002	2002	2002	2002	2002	2002	2002	2002	2002	2002	2002
K54	Yamaha-1	SKIP (-)	7C-9D	7C-9D	2002	2002	2002	2002	2002	2002	2002	2002	2002	2002	2002	2002
K55	Yamaha-1	REPEAT	7C-9E	7C-9E	2002	2002	2002	2002	2002	2002	2002	2002	2002	2002	2002	2002
K56	Yamaha-1	STOP	7C-9F	7C-9F	2002	2002	2002	2002	2002	2002	2002	2002	2002	2002	2002	2002
K57	Yamaha-1	PAUSE	7C-9G	7C-9G	2002	2002	2002	2002	2002	2002	2002	2002	2002	2002	2002	2002
K58	Yamaha-1	SKIP (+)	7C-9H	7C-9H	2002	2002	2002	2002	2002	2002	2002	2002	2002	2002	2002	2002
K59	Yamaha-1	SKIP (-)	7C-9I	7C-9I	2002	2002	2002	2002	2002	2002	2002	2002	2002	2002	2002	2002
K60	Yamaha-1	REPEAT	7C-9J	7C-9J	2002	2002	2002	2002	2002	2002	2002	2002	2002	2002	2002	2002
K61	Yamaha-1	STOP	7C-9K	7C-9K	2002	2002	2002	2002	2002	2002	2002	2002	2002	2002	2002	2002
K62	Yamaha-1	PAUSE	7C-9L	7C-9L	2002	2002	2002	2002	2002	2002	2002	2002	2002	2002	2002	2002
K63	Yamaha-1	SKIP (+)	7C-9M	7C-9M	2002	2002	2002	2002	2002	2002	2002	2002	2002	2002	2002	2002
K64	Yamaha-1	SKIP (-)	7C-9N	7C-9N	2002	2002	2002	2002	2002	2002	2002	2002	2002	2002	2002	2002
K65	Yamaha-1	REPEAT	7C-9O	7C-9O	2002	2002	2002	2002	2002	2002	2002	2002	2002	2002	2002	2002
K66	Yamaha-1	STOP	7C-9P	7C-9P	2002	2002	2002	2002	2002	2002	2002	2002	2002	2002	2002	2002
K67	Yamaha-1	PAUSE	7C-9Q	7C-9Q	2002	2002	2002	2002	2002	2002	2002	2002	2002	2002	2002	2002
K68	Yamaha-1	SKIP (+)	7C-9R	7C-9R	2002	2002	2002	2002	2002	2002	2002	2002	2002	2002	2002	2002
K69	Yamaha-1	SKIP (-)	7C-9S	7C-9S	2002	2002	2002	2002	2002	2002	2002	2002	2002	2002	2002	2002
K70	Yamaha-1	REPEAT	7C-9T	7C-9T	2002	2002	2002	2002	2002	2002	2002	2002	2002	2002	2002	2002
K71	Yamaha-1	STOP	7C-9U	7C-9U	2002	2002	2002	2002	2002	2002	2002	2002	2002	2002	2002	2002
K72	Yamaha-1	PAUSE	7C-9V	7C-9V	2002	2002	2002	2002	2002	2002	2002	2002	2002	2002	2002	2002
K73	Yamaha-1	SKIP (+)	7C-9W	7C-9W	2002	2002	2002	2002	2002	2002	2002	2002	2002	2002	2002	2002
K74	Yamaha-1	SKIP (-)	7C-9X	7C-9X	2002	2002	2002	2002	2002	2002	2002	2002	2002	2002	2002	2002
K75	Yamaha-1	REPEAT	7C-9Y	7C-9Y	2002	2002	2002	2002	2002	2002	2002	2002	2002	2002	2002	2002
K76	Yamaha-1	STOP	7C-9Z	7C-9Z	2002	2002	2002	2002	2002	2002	2002	2002	2002	2002	2002	2002
K77	Yamaha-1	PAUSE	7C-9A	7C-9A	2002	2002	2002	2002	2002	2002	2002	2002	2002	2002	2002	2002
K78	Yamaha-1	SKIP (+)	7C-9B	7C-9B	2002	2002	2002	2002	2002	2002	2002	2002	2002	2002	2002	2002
K79	Yamaha-1	SKIP (-)	7C-9C	7C-9C	2002	2002	2002	2002	2002	2002	2002	2002	2002	2002	2002	2002
K80	Yamaha-1	REPEAT	7C-9D	7C-9D	2002	2002	2002	2002	2002	2002	2002	2002	2002	2002	2002	2002
K81	Yamaha-1	STOP	7C-9E	7C-9E	2002	2002	2002	2002	2002	2002	2002	2002	2002	2002	2002	2002
K82	Yamaha-1	PAUSE	7C-9F	7C-9F	2002	2002	2002	2002	2002	2002	2002	2002	2002	2002	2002	2002
K83	Yamaha-1	SKIP (+)	7C-9G	7C-9G	2002	2002	2002	2002	2002	2002	2002	2002	2002	2002	2002	2002
K84	Yamaha-1	SKIP (-)	7C-9H	7C-9H	2002	2002	2002	2002	2002	2002	2002	2002	2002	2002	2002	2002
K85	Yamaha-1	REPEAT	7C-9I	7C-9I	2002	2002	2002	2002	2002	2002	2002	2002	2002	2002	2002	2002
K86	Yamaha-1	STOP	7C-9J	7C-9J	2002	2002	2002	2002	2002	2002	2002	2002	2002	2002	2002	2002
K87	Yamaha-1	PAUSE	7C-9K	7C-9K	2002	2002	2002	2002	2002	2002	2002	2002	2002	2002	2002	2002
K88	Yamaha-1	SKIP (+)	7C-9L	7C-9L	2002	2002	2002	2002	2002	2002	2002	2002	2002	2002	2002	2002
K89	Yamaha-1	SKIP (-)	7C-9M	7C-9M	2002	2002	2002	2002	2002	2002	2002	2002	2002	2002	2002	2002
K90	Yamaha-1	REPEAT	7C-9N	7C-9N	2002	2002	2002	2002	2002	2002	2002	2002	2002	2002	2002	2002
K91	Yamaha-1	STOP	7C-9O	7C-9O	2002	2002	2002	2002	2002	2002	2002	2002	2002	2002	2002	2002
K92	Yamaha-1	PAUSE	7C-9P	7C-9P	2002	2002	2002	2002	2002	2002	2002	2002	2002	2002	2002	2002
K93	Yamaha-1	SKIP (+)	7C-9Q	7C-9Q	2002	2002	2002	2002	2002	2002	2002	2002	2002	2002	2002	2002
K94	Yamaha-1	SKIP (-)	7C-9R	7C-9R	2002	2002	2002	2002	2002	2002	2002	2002	2002	2002	2002	2002
K95	Yamaha-1	REPEAT	7C-9S	7C-9S	2002	2002	2002	2002	2002	2002	2002	2002	2002	2002	2002	2002
K96	Yamaha-1	STOP	7C-9T	7C-9T	2002	2002	2002	2002	2002	2002	2002	2002	2002	2002	2002	2002
K97	Yamaha-1	PAUSE	7C-9U	7C-9U	2002	2002	2002	2002	2002	2002	2002	2002	2002	2002	2002	2002
K98	Yamaha-1	SKIP (+)	7C-9V	7C-9V	2002	2002	2002	2002	2002	2002	2002	2002	2002	2002	2002	2002
K99	Yamaha-1	SKIP (-)	7C-9W	7C-9W	2002	2002	2002	2002	2002	2002	2002	2002	2002	2002	2002	2002
K100	Yamaha-1	REPEAT	7C-9X	7C-9X	2002	2002	2002	2002	2002	2002	2002	2002	2002	2002	2002	2002

TUNER

Key No.	Brand	Function	Yamaha-2		Yamaha-3		Yamaha-4		Yamaha-5		Yamaha-6		Yamaha-7		Yamaha-8		Yamaha-9		Yamaha-10		Yamaha-11		Yamaha-12	
			5014	5017	5020	5023	5026	5029	5032	5035	5038	5041	5044	5047	5050	5053	5056	5059	5062	5065	5068	5071	5074	5077
K101	Yamaha-2 <td>PRESET (+) <td>7A-10</td> <td>7A-10</td> <td>7A-10</td> <td>7A-10</td> <td>7A-10</td> <td>7A-10</td> <td>7A-10</td> <td>7A-10</td> <td>7A-10</td> <td>7A-10</td> <td>7A-10</td> <td>7A-10</td> <td>7A-10</td> <td>7A-10</td> <td>7A-10</td> <td>7A-10</td> <td>7A-10</td> <td>7A-10</td> <td>7A-10</td> <td>7A-10</td> <td>7A-10</td> <td>7A-10</td> </td>	PRESET (+) <td>7A-10</td> <td>7A-10</td> <td>7A-10</td> <td>7A-10</td> <td>7A-10</td> <td>7A-10</td> <td>7A-10</td> <td>7A-10</td> <td>7A-10</td> <td>7A-10</td> <td>7A-10</td> <td>7A-10</td> <td>7A-10</td> <td>7A-10</td> <td>7A-10</td> <td>7A-10</td> <td>7A-10</td> <td>7A-10</td> <td>7A-10</td> <td>7A-10</td> <td>7A-10</td> <td>7A-10</td>	7A-10	7A-10	7A-10	7A-10	7A-10	7A-10	7A-10	7A-10	7A-10	7A-10	7A-10	7A-10	7A-10	7A-10	7A-10	7A-10	7A-10	7A-10	7A-10	7A-10	7A-10	7A-10
K102	Yamaha-2 <td>PRESET (-) <td>7A-11</td> <td>7A-11</td> <td>7A-11</td> <td>7A-11</td> <td>7A-11</td> <td>7A-11</td> <td>7A-11</td> <td>7A-11</td> <td>7A-11</td> <td>7A-11</td> <td>7A-11</td> <td>7A-11</td> <td>7A-11</td> <td>7A-11</td> <td>7A-11</td> <td>7A-11</td> <td>7A-11</td> <td>7A-11</td> <td>7A-11</td> <td>7A-11</td> <td>7A-11</td> <td>7A-11</td> </td>	PRESET (-) <td>7A-11</td> <td>7A-11</td> <td>7A-11</td> <td>7A-11</td> <td>7A-11</td> <td>7A-11</td> <td>7A-11</td> <td>7A-11</td> <td>7A-11</td> <td>7A-11</td> <td>7A-11</td> <td>7A-11</td> <td>7A-11</td> <td>7A-11</td> <td>7A-11</td> <td>7A-11</td> <td>7A-11</td> <td>7A-11</td> <td>7A-11</td> <td>7A-11</td> <td>7A-11</td> <td>7A-11</td>	7A-11	7A-11	7A-11	7A-11	7A-11	7A-11	7A-11	7A-11	7A-11	7A-11	7A-11	7A-11	7A-11	7A-11	7A-11	7A-11	7A-11	7A-11	7A-11	7A-11	7A-11	7A-11
K103	Yamaha-2 <td>ENTER <td>7A-12</td> <td>7A-12</td> <td>7A-12</td> <td>7A-12</td> <td>7A-12</td> <td>7A-12</td> <td>7A-12</td> <td>7A-12</td> <td>7A-12</td> <td>7A-12</td> <td>7A-12</td> <td>7A-12</td> <td>7A-12</td> <td>7A-12</td> <td>7A-12</td> <td>7A-12</td> <td>7A-12</td> <td>7A-12</td> <td>7A-12</td> <td>7A-12</td> <td>7A-12</td> <td>7A-12</td> </td>	ENTER <td>7A-12</td> <td>7A-12</td> <td>7A-12</td> <td>7A-12</td> <td>7A-12</td> <td>7A-12</td> <td>7A-12</td> <td>7A-12</td> <td>7A-12</td> <td>7A-12</td> <td>7A-12</td> <td>7A-12</td> <td>7A-12</td> <td>7A-12</td> <td>7A-12</td> <td>7A-12</td> <td>7A-12</td> <td>7A-12</td> <td>7A-12</td> <td>7A-12</td> <td>7A-12</td> <td>7A-12</td>	7A-12	7A-12	7A-12	7A-12	7A-12	7A-12	7A-12	7A-12	7A-12	7A-12	7A-12	7A-12	7A-12	7A-12	7A-12	7A-12	7A-12	7A-12	7A-12	7A-12	7A-12	7A-12
K104	Yamaha-2 <td>RETURN <td>7A-13</td> <td>7A-13</td> <td>7A-13</td> <td>7A-13</td> <td>7A-13</td> <td>7A-13</td> <td>7A-13</td> <td>7A-13</td> <td>7A-13</td> <td>7A-13</td> <td>7A-13</td> <td>7A-13</td> <td>7A-13</td> <td>7A-13</td> <td>7A-13</td> <td>7A-13</td> <td>7A-13</td> <td>7A-13</td> <td>7A-13</td> <td>7A-13</td> <td>7A-13</td> <td>7A-13</td> </td>	RETURN <td>7A-13</td> <td>7A-13</td> <td>7A-13</td> <td>7A-13</td> <td>7A-13</td> <td>7A-13</td> <td>7A-13</td> <td>7A-13</td> <td>7A-13</td> <td>7A-13</td> <td>7A-13</td> <td>7A-13</td> <td>7A-13</td> <td>7A-13</td> <td>7A-13</td> <td>7A-13</td> <td>7A-13</td> <td>7A-13</td> <td>7A-13</td> <td>7A-13</td> <td>7A-13</td> <td>7A-13</td>	7A-13	7A-13	7A-13	7A-13	7A-13	7A-13	7A-13	7A-13	7A-13	7A-13	7A-13	7A-13	7A-13	7A-13	7A-13	7A-13	7A-13	7A-13	7A-13	7A-13	7A-13	7A-13
K105	Yamaha-2 <td>STOP <td>7A-14</td> <td>7A-14</td> <td>7A-14</td> <td>7A-14</td> <td>7A-14</td> <td>7A-14</td> <td>7A-14</td> <td>7A-14</td> <td>7A-14</td> <td>7A-14</td> <td>7A-14</td> <td>7A-14</td> <td>7A-14</td> <td>7A-14</td> <td>7A-14</td> <td>7A-14</td> <td>7A-14</td> <td>7A-14</td> <td>7A-14</td> <td>7A-14</td> <td>7A-14</td> <td>7A-14</td> </td>	STOP <td>7A-14</td> <td>7A-14</td> <td>7A-14</td> <td>7A-14</td> <td>7A-14</td> <td>7A-14</td> <td>7A-14</td> <td>7A-14</td> <td>7A-14</td> <td>7A-14</td> <td>7A-14</td> <td>7A-14</td> <td>7A-14</td> <td>7A-14</td> <td>7A-14</td> <td>7A-14</td> <td>7A-14</td> <td>7A-14</td> <td>7A-14</td> <td>7A-14</td> <td>7A-14</td> <td>7A-14</td>	7A-14	7A-14	7A-14	7A-14	7A-14	7A-14	7A-14	7A-14	7A-14	7A-14	7A-14	7A-14	7A-14	7A-14	7A-14	7A-14	7A-14	7A-14	7A-14	7A-14	7A-14	7A-14
K106	Yamaha-2 <td>PAUSE <td>7A-15</td> <td>7A-15</td> <td>7A-15</td> <td>7A-15</td> <td>7A-15</td> <td>7A-15</td> <td>7A-15</td> <td>7A-15</td> <td>7A-15</td> <td>7A-15</td> <td>7A-15</td> <td>7A-15</td> <td>7A-15</td> <td>7A-15</td> <td>7A-15</td> <td>7A-15</td> <td>7A-15</td> <td>7A-15</td> <td>7A-15</td> <td>7A-15</td> <td>7A-15</td> <td>7A-15</td> </td>	PAUSE <td>7A-15</td> <td>7A-15</td> <td>7A-15</td> <td>7A-15</td> <td>7A-15</td> <td>7A-15</td> <td>7A-15</td> <td>7A-15</td> <td>7A-15</td> <td>7A-15</td> <td>7A-15</td> <td>7A-15</td> <td>7A-15</td> <td>7A-15</td> <td>7A-15</td> <td>7A-15</td> <td>7A-15</td> <td>7A-15</td> <td>7A-15</td> <td>7A-15</td> <td>7A-15</td> <td>7A-15</td>	7A-15	7A-15	7A-15	7A-15	7A-15	7A-15	7A-15	7A-15	7A-15	7A-15	7A-15	7A-15	7A-15	7A-15	7A-15	7A-15	7A-15	7A-15	7A-15	7A-15	7A-15	7A-15
K107	Yamaha-2 <td>SKIP (+) </td>	SKIP (+)																						

Advanced setup

In the advanced setup, you can set basic operations of this unit, or initialize user settings. Perform the following steps to change settings.

1 Set this unit to the standby mode.

- 2 Press **Ⓐ** **STANDBY/ON** while pressing and holding **Ⓛ** **STRAIGHT** on the front panel. The advanced setup menu appears on the front panel display.

ADVANCED SETUP

3 Press **Ⓚ** **PROGRAM** **◀/▶** repeatedly to select the parameter you want to change.

The default setting are marked with “*.”



- XXX in the following parameters indicate the set values.

SP IMP. - XXX

Choices: 6ΩMIN/8ΩMIN*

Selects output impedance of this unit according to connected speakers.

REMOTE ID-XXX

Choices: ID1*/ID2

Sets a remote control ID. When using multiple Yamaha AV receivers, you can operate them with a single remote control by setting the receiver IDs to the same setting.

INIT-XXXXXXXXXX

Choices: DSP PARAM/ALL/CANCEL

Initializes various settings stored in this unit. You can select an initialization method from the following.

DSP PARAM: All parameters of sound field programs
 ALL: Reset this unit to initial factory settings
 CANCEL: Cancellation of initialization

4 Press **Ⓛ** **STRAIGHT** a few times to select the value you want to change.

The value selected here becomes effective when this unit is turned on the next time. You can change multiple settings by repeating steps 3 and 4.

5 Press **Ⓐ** **STANDBY/ON**, turns off this system, and press **Ⓐ** **STANDBY/ON** again.

The value set in step 3 becomes effective, and this unit turns on. When you select initialization in step 3, the initialization is performed.

Setting a remote control ID

Two IDs are provided for the remote control of this unit. If another Yamaha amplifier is in the same room, setting a different remote control ID to this unit prevents unwanted operation of the other amplifier.

ID1 is set for both remote control and amplifier by default. When you change the remote control ID, display “Advance Setup” (see the previous section) and change the ID for the amplifier too.

1 Press **Ⓜ** **CODE SET** on the remote control using a pointed object such as the tip of a ballpoint pen.

Ⓜ **TRANSMIT** blinks twice.

2 Press **Ⓜ** **SETUP** on the remote control.

3 Enter the desired remote control ID code.

To switch to ID1:

Enter “5019” using **Ⓜ** **Numeric keys**.

To switch to ID2:

Enter “5020” using **Ⓜ** **Numeric keys**.

Once the remote control code is registered,

Ⓜ **TRANSMIT** blinks twice.

If it fails, **Ⓜ** **TRANSMIT** blinks six times. Repeat from step 1.



- Initializing the remote control code returns it to ID1.

本機の基本設定 / 初期化を行う (アドバンスドセットアップメニュー)

アドバンスドセットアップメニューでは、本機の基本設定や、ユーザー設定の初期化を行うことができます。次の操作で目的の操作を行ってください。

1 本機の電源をスタンバイに切り替えます。

- 2 フロントパネルの④STRAIGHTを押しながら、⑤STANDBY/ONを押します。フロントパネルディスプレイにアドバンスドセットアップメニューが表示されます。

ADVANCED SETUP

- 3 ⑥PROGRAM ◀ / ▶ を繰り返し押し、次の中から設定したい項目を選択します。「*」は初期設定を表します。



• 実際のディスプレイ表示は、XXXの部分に設定値が入りません。

REMOTE ID -XXX

選択項目：ID1* / ID2

リモコンのIDを設定します。ヤマハ製AVレシーバーを複数使用する場合、各レシーバーのIDを同じ設定にすると、1つのリモコンですべてのレシーバーを操作できます。IDを分けた場合は、それぞれのリモコンで、レシーバーごとに操作が行えます。

INIT-XXXXXXXXXX

選択項目：DSP PARAM / ALL / CANCEL

本機に記憶された各種設定を初期化します。初期化方法は、次の中から選択できます。

DSP PARAM：音場プログラムの設定値

ALL：本機を工場出荷時の状態に戻します。

CANCEL：初期化のキャンセル

- 4 ④STRAIGHTを何度か押して、目的の設定値を選びます。

ここで選択した内容は、次に電源をオンにしたときに実行されます。手順3と4を繰り返して、複数の項目を設定することも可能です。

- 5 ⑤STANDBY/ONを押して電源を切り、もう一度⑤STANDBY/ONを押します。手順4で行なった設定が反映され、本機の電源がオンになります。手順3で初期化を選択した場合は初期化が実行されます。

リモコンIDを設定する

本機のリモコンは、2つのID(リモコンID)からいずれか1つを選ぶことができます。本機を設置している部屋で別のヤマハ製アンプをお使いの場合、本機のリモコンIDを切り替えることで、もう1台のアンプが動作するのを防止できます。

工場出荷時には、リモコン側、アンプ側ともにID1に設定されています。本機のリモコンIDを切り替えた場合、「Advance Setup」(前項目参照)を表示して必ずアンプ側のIDも切り替えてください。

- 1 ボールペンなどの先の細いもので、リモコンの③CODE SETを押す。②TRANSMITが2回点滅します。

- 2 リモコンの②SETUPを押す。

- 3 希望するリモコンIDコードを入力する。

リモコンID1に切り替える場合：

④数字キーを押して「5019」と入力します。

リモコンID2に切り替える場合：

④数字キーを押して「5020」と入力します。

登録が完了すると、コード入力後にリモコンの②TRANSMITが2回点滅します。

リモコンの②TRANSMITが6回点滅した場合は、リモコンコードの入力に失敗したことを表します。もう一度手順1からやり直してください。



• リモコンコードを初期化すると、リモコンID1に戻ります。

MEMO

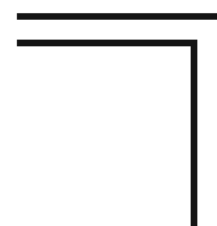
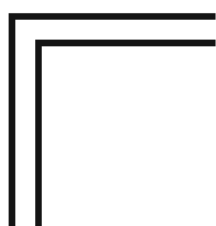

RX-V465/HTR-6240/
AX-V465

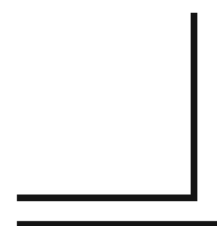
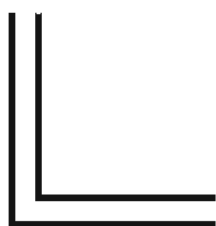

**RX-V465/HTR-6240/
AX-V465**

